

LINSY 林氏家居

五金表/Hardware list

部件表/Parts List

安装示意图/Assembly Instruction

产品名称 Model NO.	茶几
产品型号 Product Model	PT1L-A (1.2m)
尺寸规格 Specification	(1200*684*300) mm
安装工具 Tool	安装人数 Installer

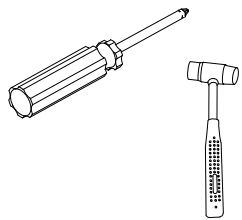

注：为保证设计效果，部分尺寸为定制尺寸，不影响使用。

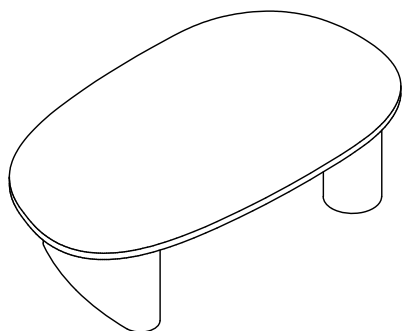

(A)* 16

斜边十字螺杆-M6x30
bevel cross screw



(B)* 6

灰色毛毡脚垫
Footrest - Grey

编号NO.	名称Name	规格 (mm) Specification	数量 QTY	材质Material
①	面板 Top panel	1200*684*20	1	白蜡木Ash
②	左底板 Bottom board(L)	520*180*18	1	纤维板 Fiberboard
③	右底板 Bottom board(R)	550*180*18	1	纤维板 Fiberboard
④	圆脚 Round foot	259*150*150	2	纤维板 Fiberboard
⑤	脚架 Tripod	259*500*150	1	纤维板 Fiberboard

PT1L-A(1.2m)

产品分解图/
exploded drawing

部件表/Parts List

编号NO.	名称Name
①	面板 Top panel
②	左底板 Bottom board(L)
③	右底板 Bottom board(R)
④	圆脚 Round foot
⑤	脚架 Tripod

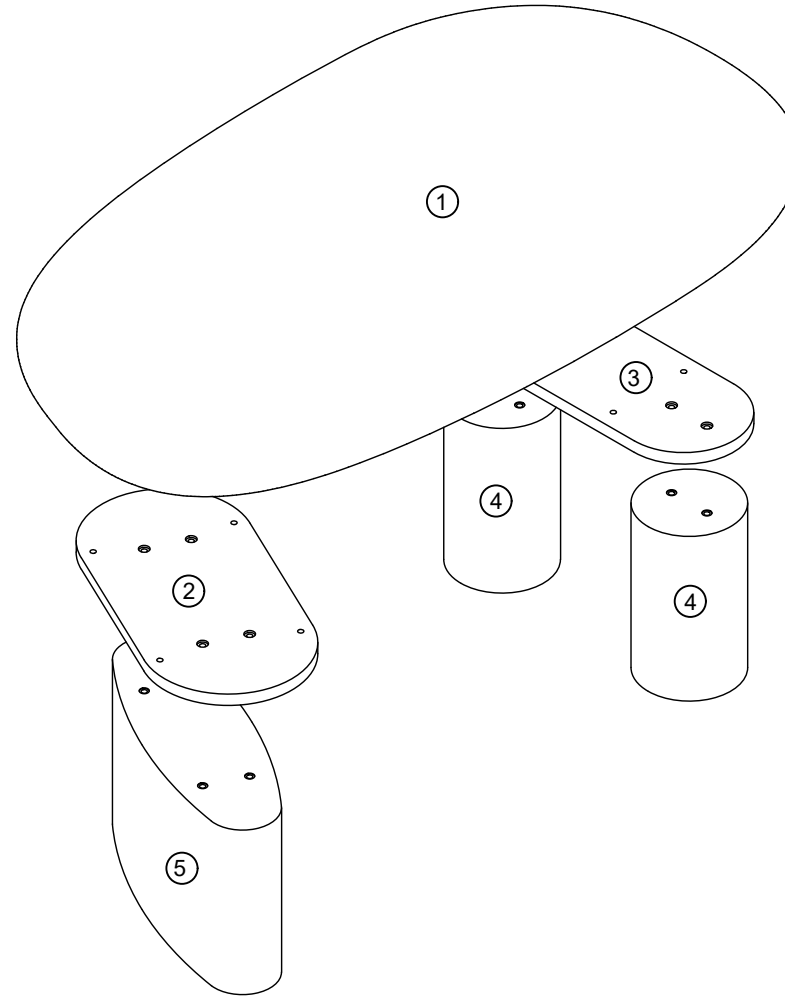

PT1L-A(1.2m)

安装方法/
Installation method

(A)*4

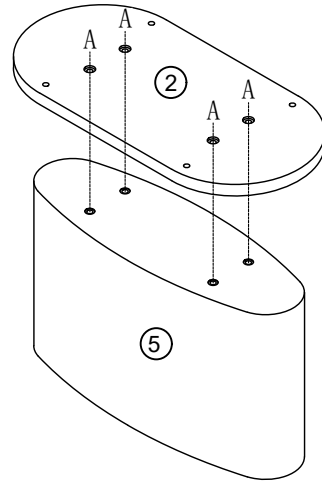

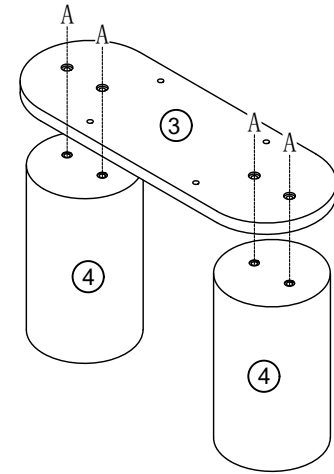

1

(A)*4



2

(A)*8

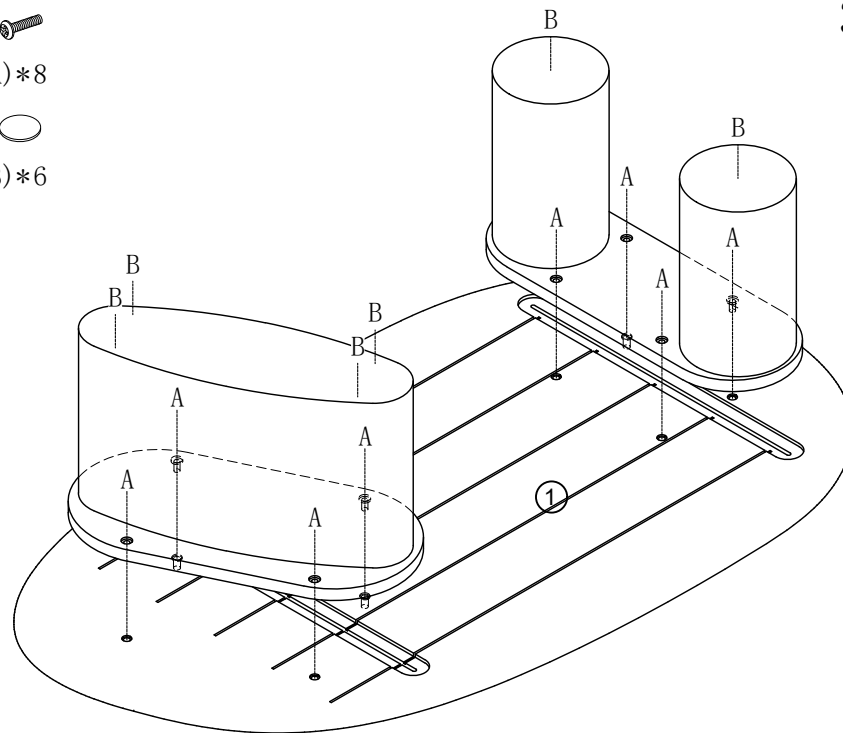
(B)*6



3

4

