

Assembly Instructions

Solidwood Mio Kids Bookshelf

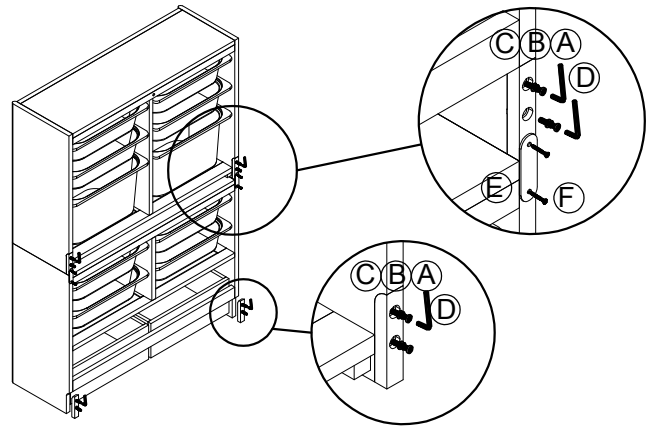

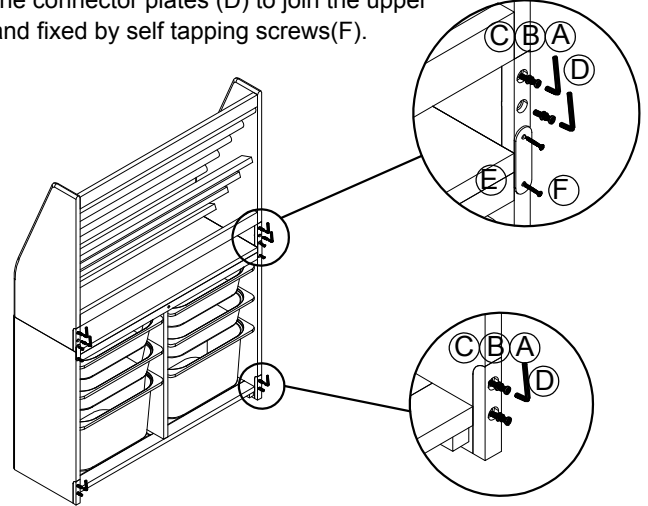

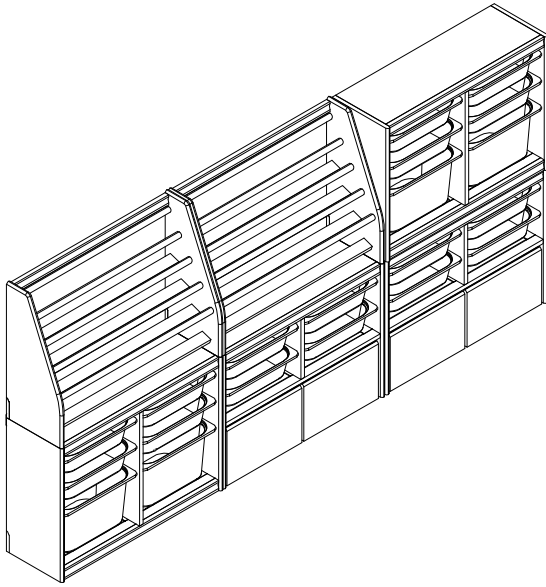

1. Install the Kickboard: Attach the removable kickboard using the screws (A), flat washers (B), and spring washers (C). Secure it with the Allen wrench (D).

2. Connect Upper and Lower Sections: Use the connector plates (E) to join the upper and lower parts of the storage unit securely and fixed by self tapping screws(F).



Note: The kickboard installation is optional and can be done based on your preference.

Hardware List:

<p>A</p> 	<p>B</p> 	<p>C</p> 	<p>D</p> 	<p>E</p> 	<p>F</p> 
Flat-Head Hex Screws=8	Spring Washers=4	Flat Washers=4	L-shaped Allen Wrench=1	Connector Plates=2	Self-Tapping Screws=4