

产品型号: 西雅图B沙发 (双人位)  
Product Model: Seattle B Sofa (Two-Seater)

# 组 装 说 明 书

## Assembly Manual

成品图:  
Assembly View:

第一步:  
Step 1:

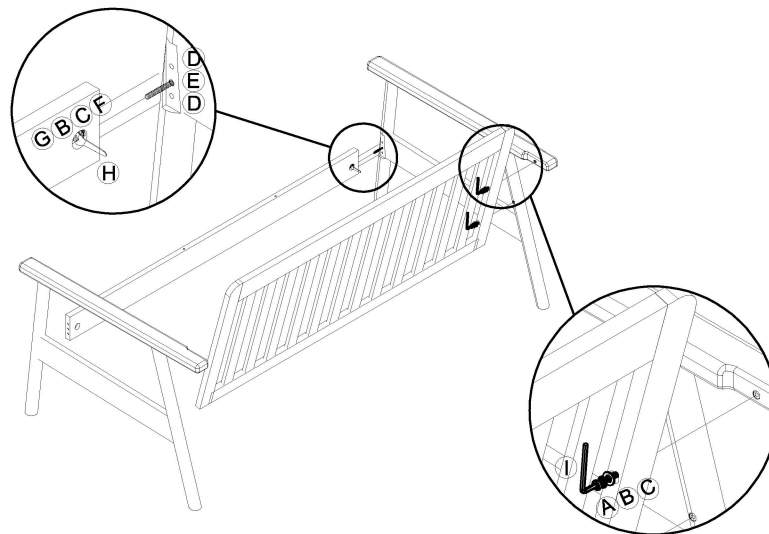



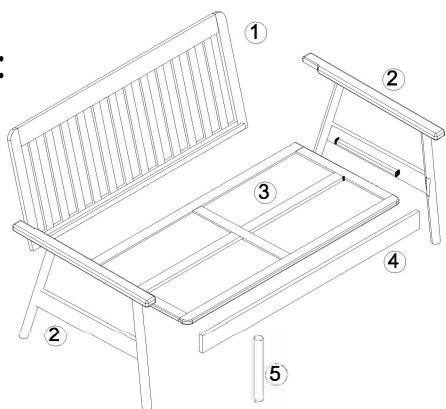



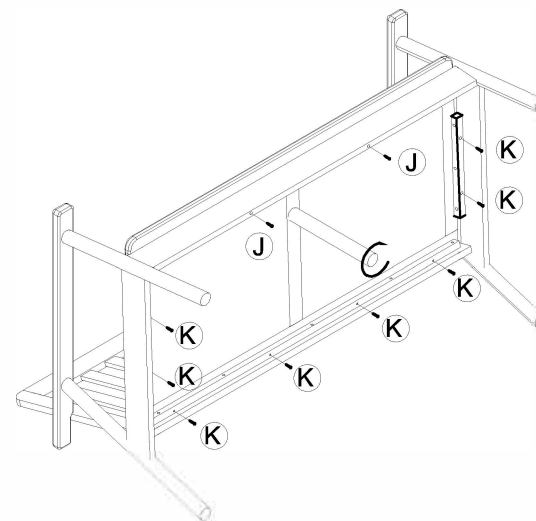



爆炸图:  
Exploded View:



第二步:  
Step 2:



五金清单:

<b>A</b>  M8 Hex Socket Screw x 4 内六角螺杆 M8 x 4	<b>B</b>  M8 Spring Washer x 6 M8 弹垫 X 6	<b>C</b>  M8 Flat Washers x 6 M8 垫片 X 6	<b>D</b>  Wooden Dowels $\phi$ 10*30 x 2 木榫 $\phi$ 10*30 X 2	<b>E</b>  Fully Threaded Rods M8*80 x 2 全丝螺杆 M8*80 X2	<b>F</b>  Half-Moon Washer 半月牙 X2
<b>G</b>  Nut x 2 螺母 X2	<b>H</b>  Wrench x 1 扳手 X1	<b>I</b>  Hex Socket M5 x 1 内六角 M5 X1	<b>J</b>  Self-Tapping Screws M4*50 x 2 自攻丝 M4*50 X 2	<b>K</b>  Self-Tapping Screws M4*30 x 8 M4*30自攻丝 X 8	