

产品型号: 西雅图B沙发 (双人位)
Product Model: Seattle B Sofa (Two-Seater)

组装说明书 Assembly Manual

成品图:
Assembly View:

第一步:
Step 1:

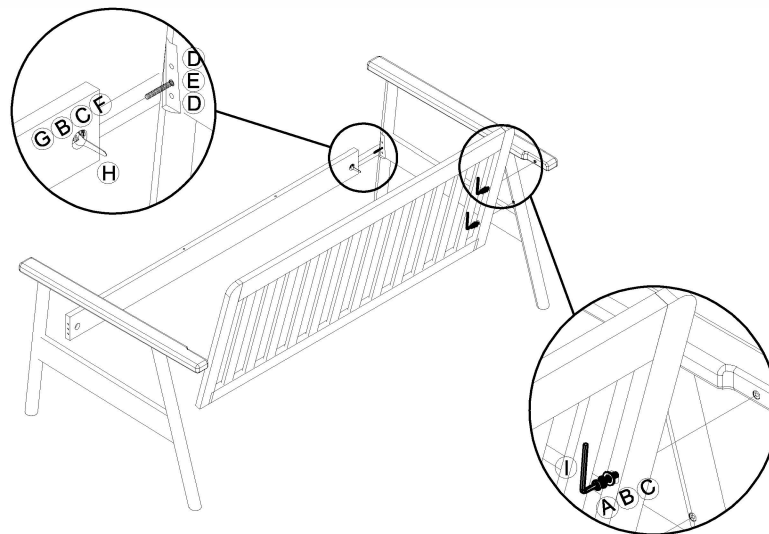



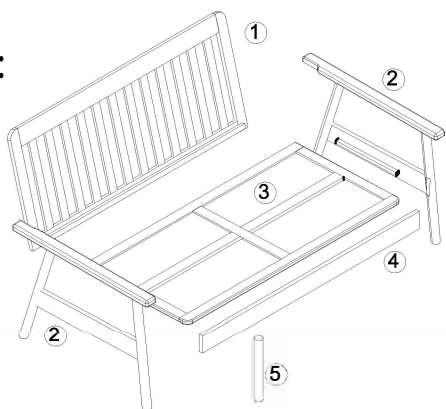



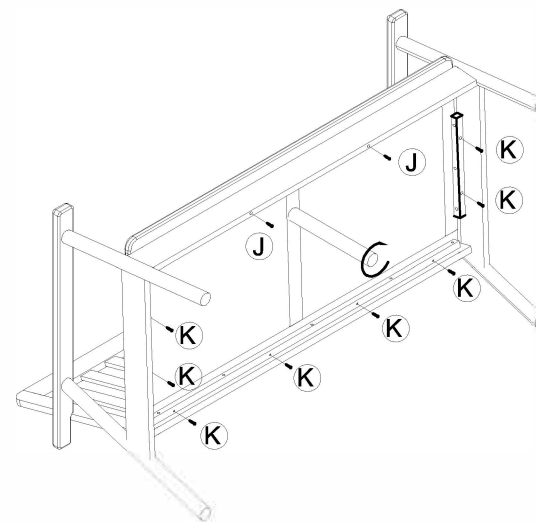



爆炸图:
Exploded View:



第二步:
Step 2:



五金清单:

A  M8 Hex Socket Screw x 4 内六角螺杆 M8 x 4	B  M8 Spring Washer x 6 M8 弹垫 X 6	C  M8 Flat Washers x 6 M8 垫片 X 6	D  Wooden Dowels ϕ 10*30 x 2 木榫 ϕ 10*30 X 2	E  Fully Threaded Rods M8*80 x 2 全丝螺杆 M8*80 X2	F  Half-Moon Washer 半月牙 X2
G  Nut x 2 螺母 X2	H  Wrench x 1 扳手 X1	I  Hex Socket M5 x 1 内六角 M5 X1	J  Self-Tapping Screws M4*50 x 2 自攻丝 M4*50 X 2	K  Self-Tapping Screws M4*30 x 8 M4*30自攻丝 X 8	