

LINSY 林氏家居

安装示意图/Assembly Instruction

产品名称 Model NO.	LH094R1-A 1.2m
产品规格 Specification	1200*800*750MM
安装工具 Tool	安装人数 Installer
	

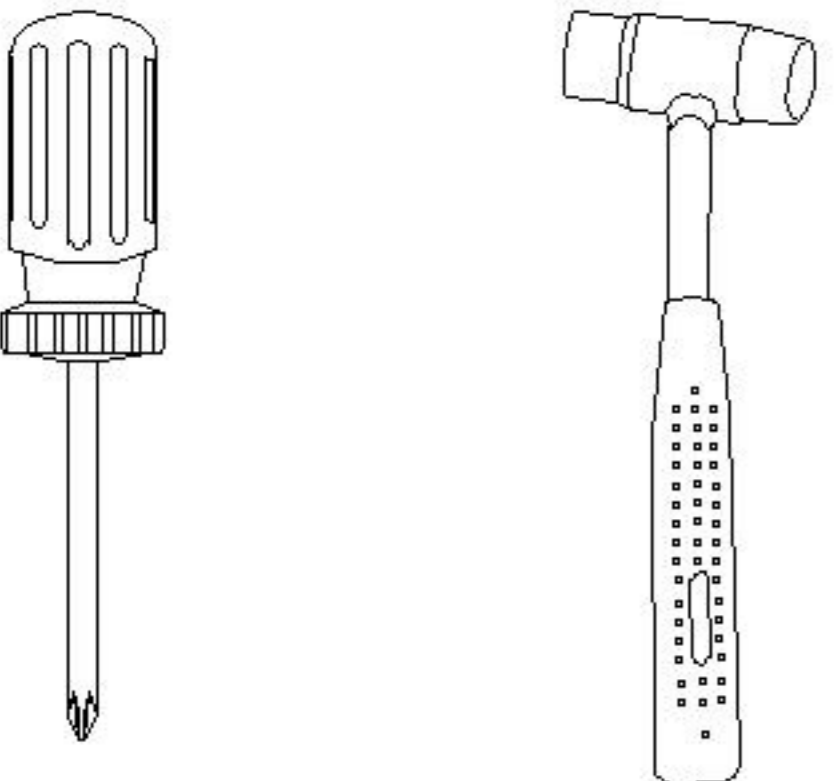
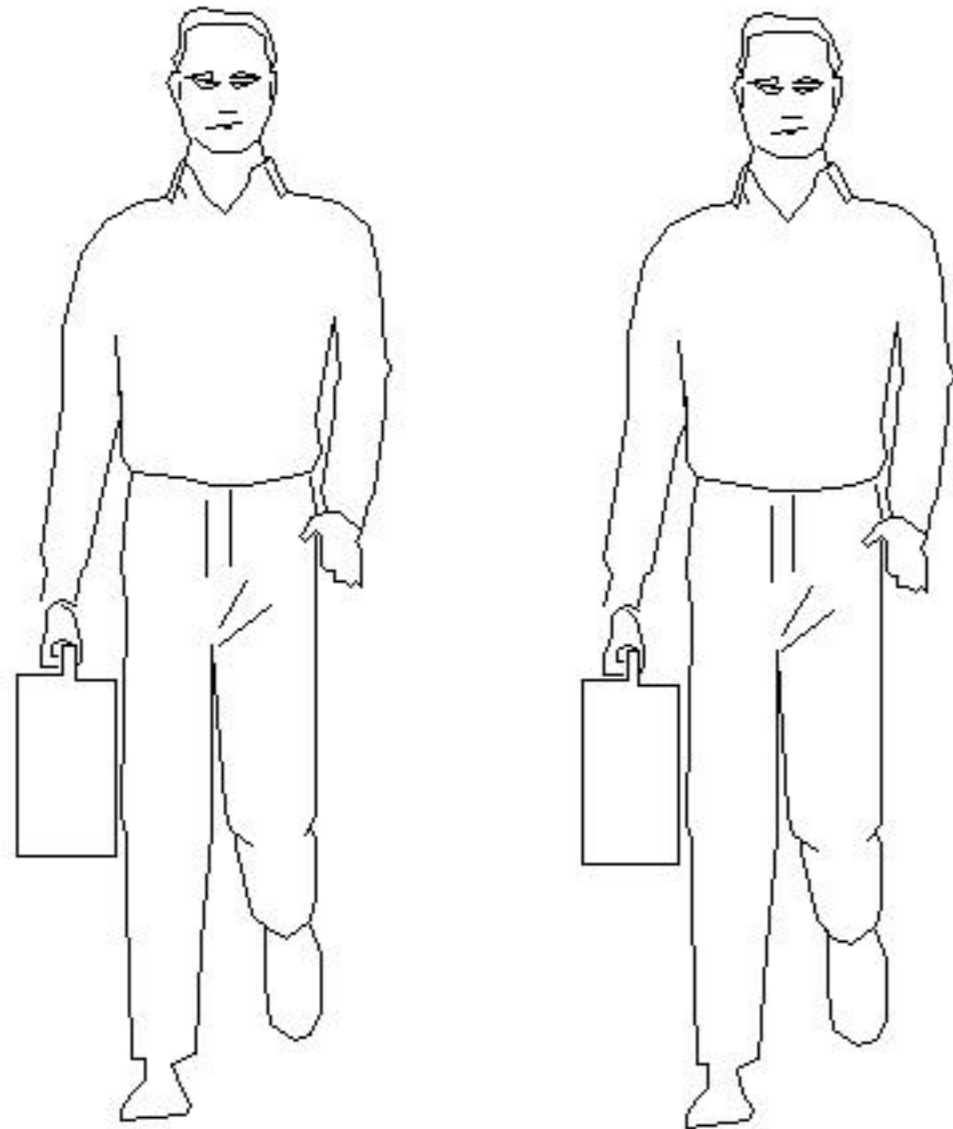
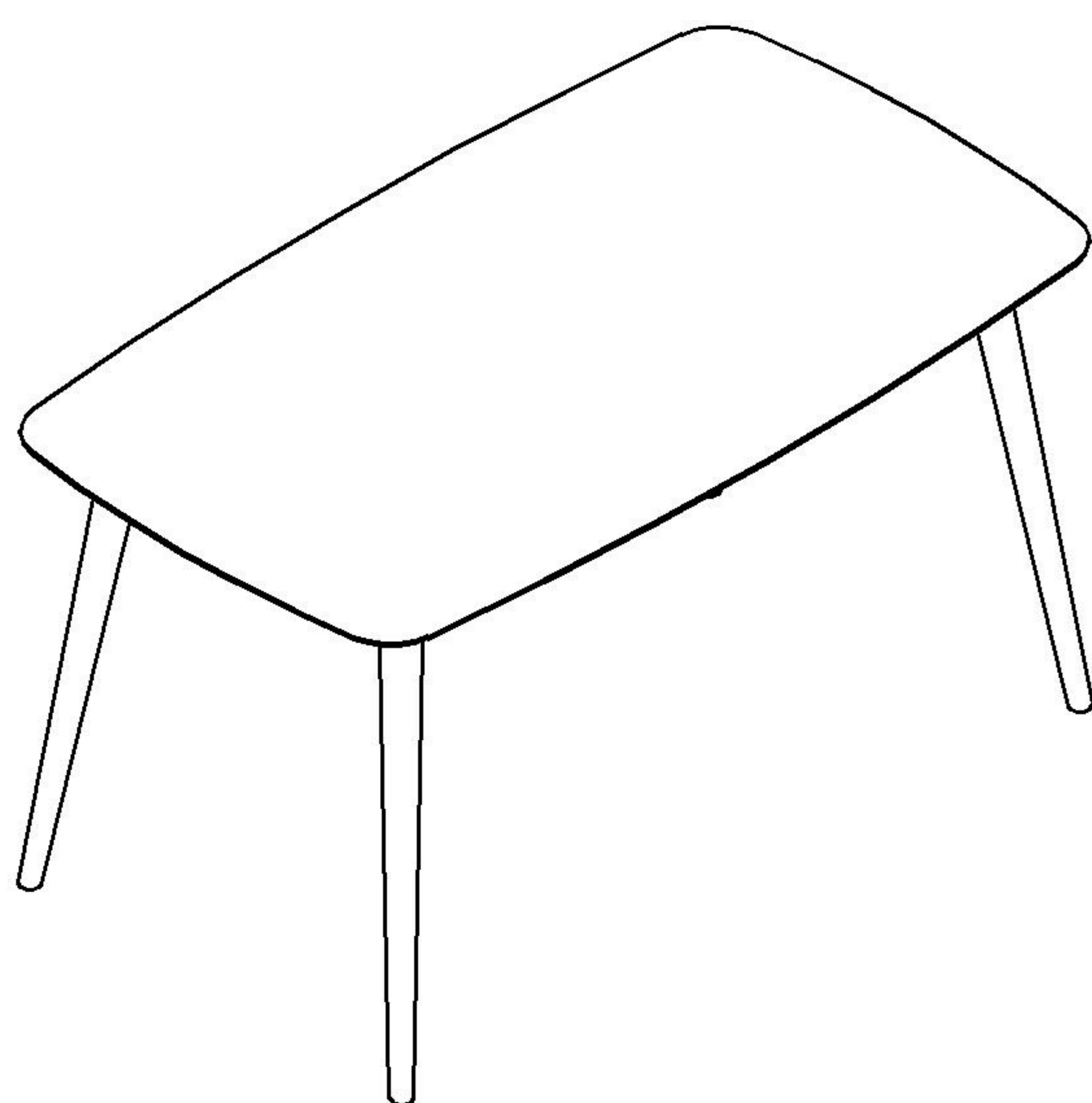

五金表/Hardware list

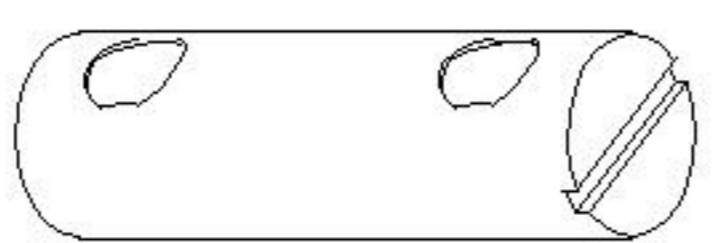
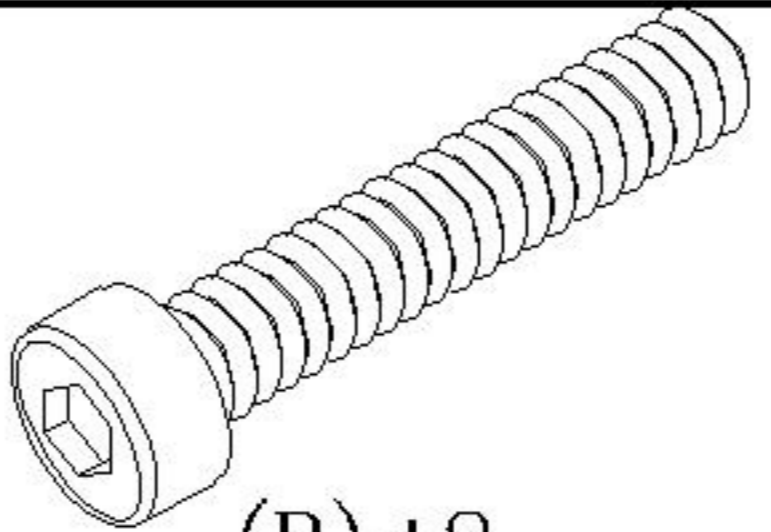
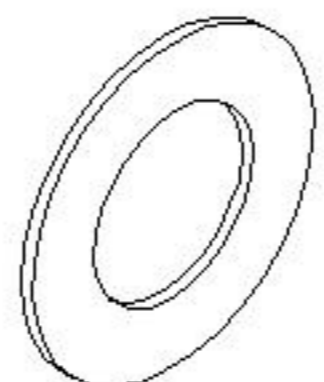
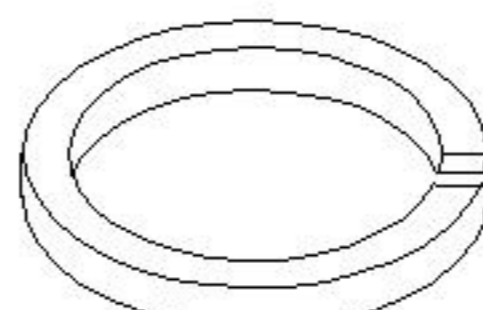
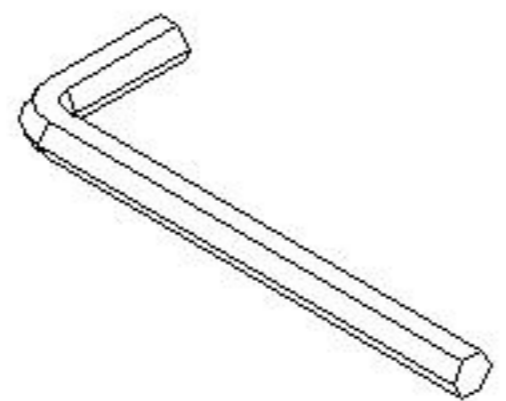
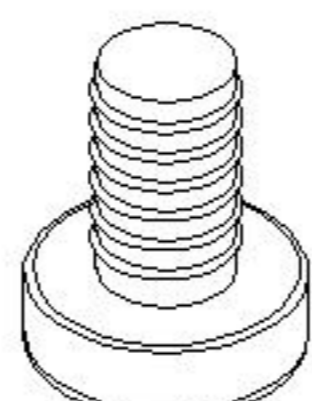
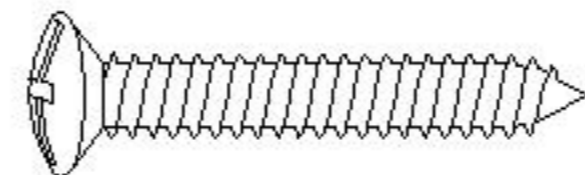
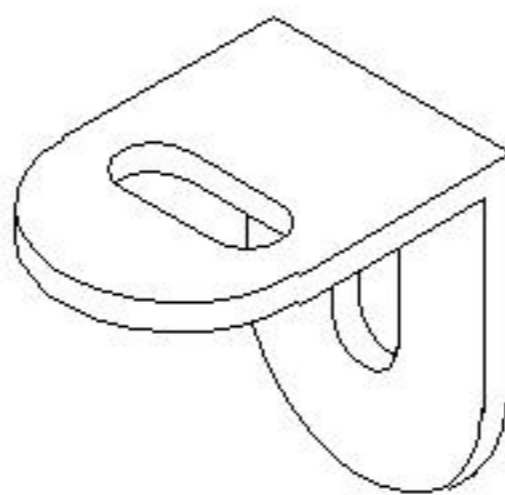
 (A)*4 双孔锤母M8 Ø12x60 Hammer nut	 (B)*8 柱头内六角螺杆-M8x75 Hexagon socket head screw	 (C)*8 垫片-(M8) shim-(M8)	 (D)*8 弹簧垫片M8.5 Spring shim
 (E)*1 6mm内六角扳手 Hexagon wrench	 (F)*4 胶塞-9厘PVC脚垫 Rubber stopper	 (G)*13 大扁头自攻螺丝M4*16 Flat head tapping screw	 (H)*6 L型角码25*25*18 Bracket

部件表/Parts List

编号NO.	名称Name	规格Specification	数量QTY	材质Material
①	立水组框 Apron frame	922*546*70	1	实木 Solid Wood
②	脚 Foot	752*60*60	4	实木 Solid Wood
③	面板 Top panel	1200*800*26	1	岩板 Sintered Stone

LH094R1-A 1.2m

安装方法/
Installation method

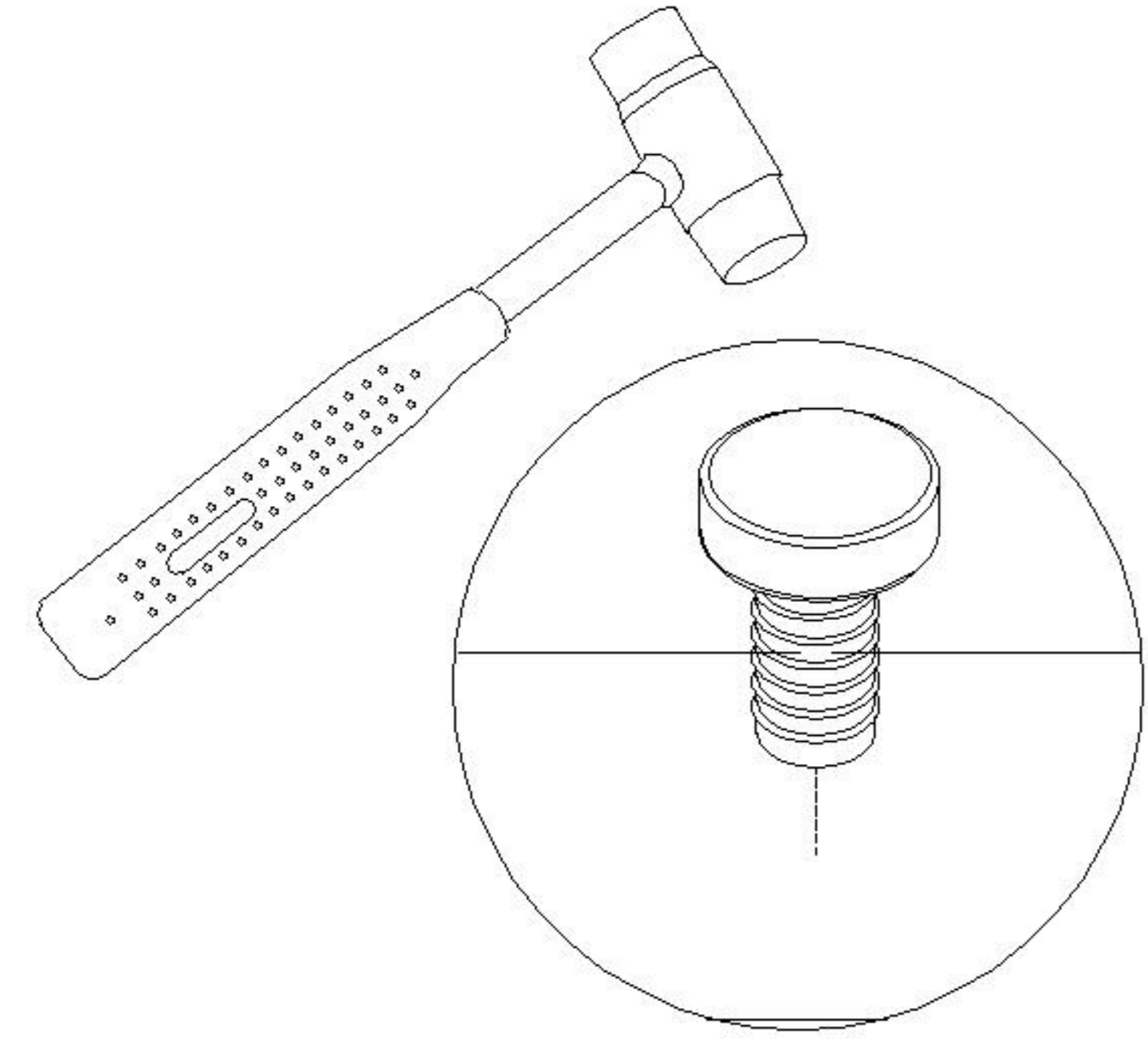

脚垫
Rubber stopper

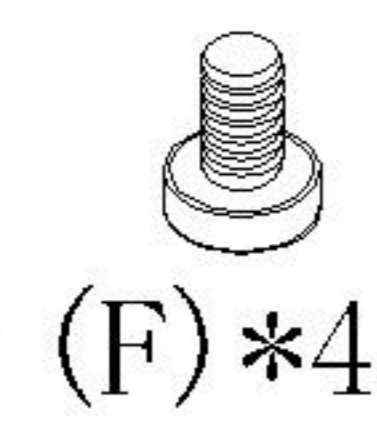

(F) *4

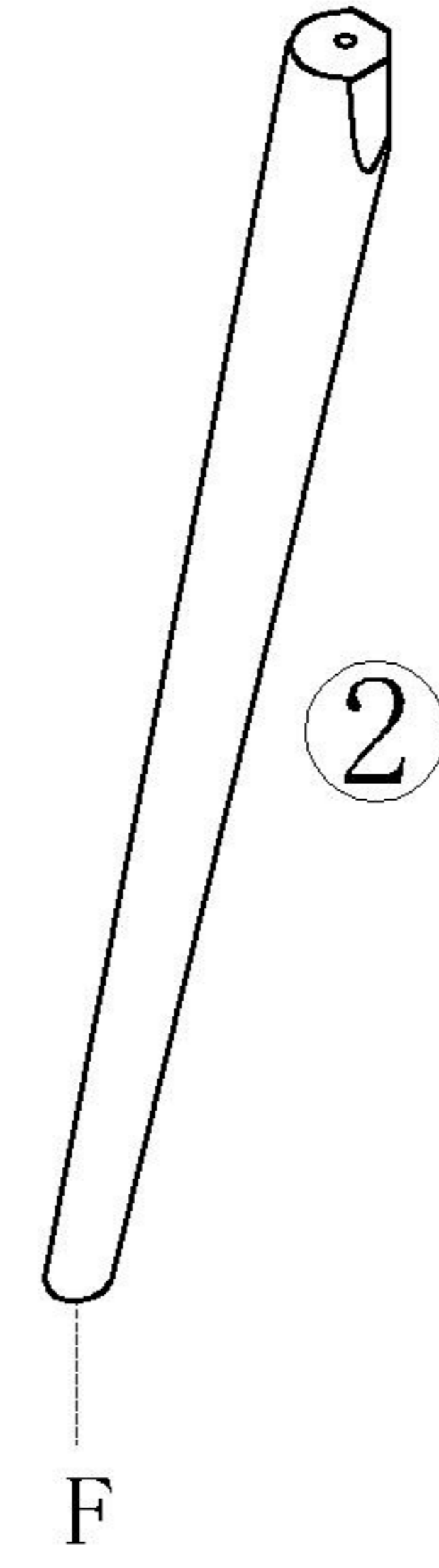

X4

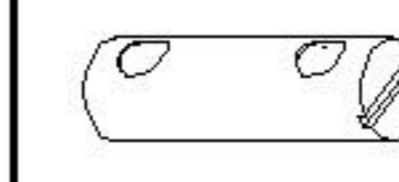

(A) *4

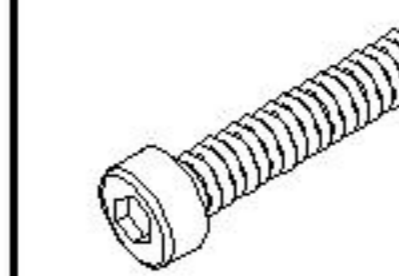

(B) *8



(C) *8

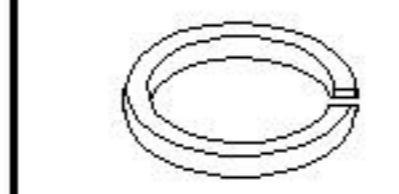

(D) *8



(E) *1

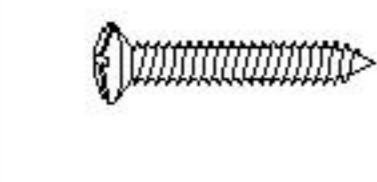
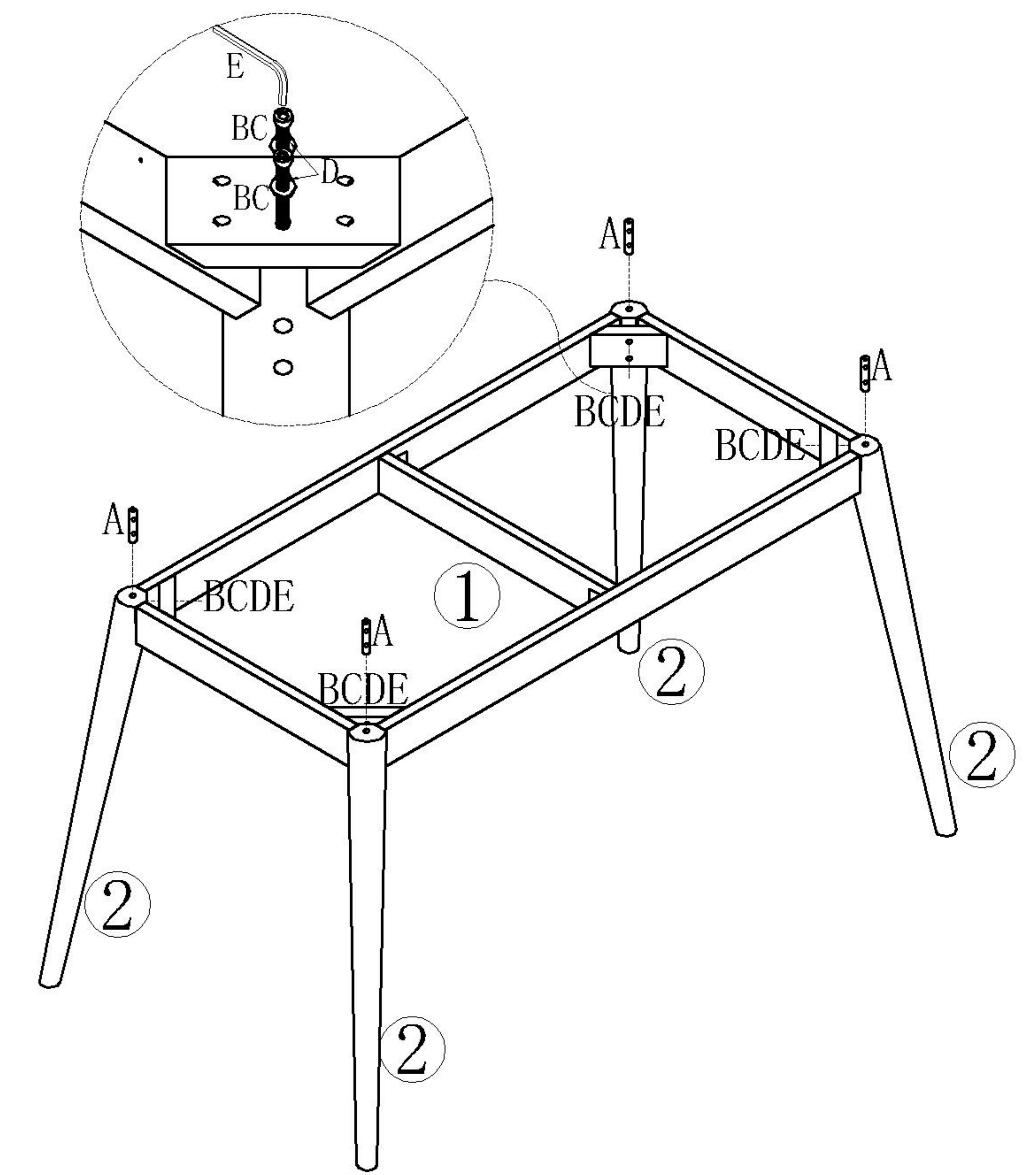

(G) *12

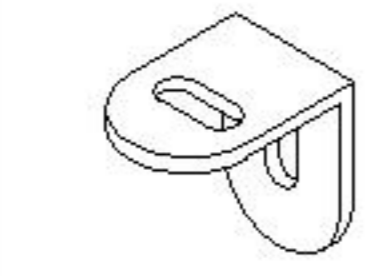

(H) *6

