

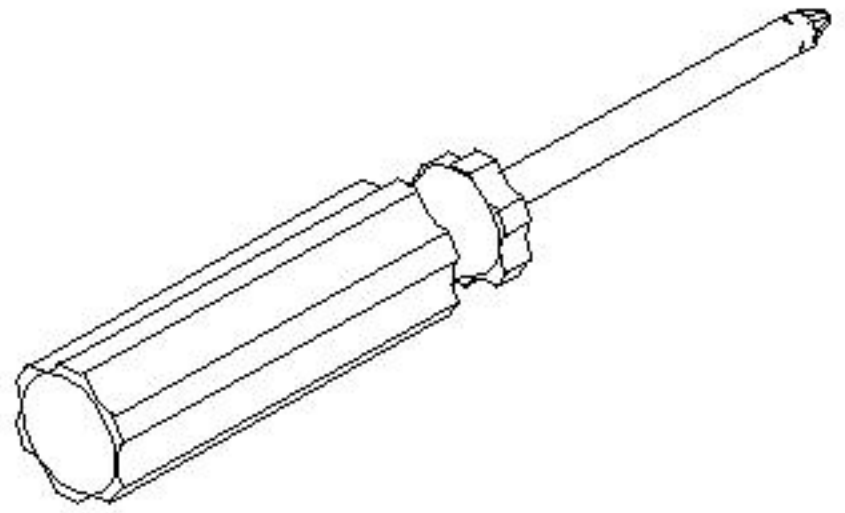

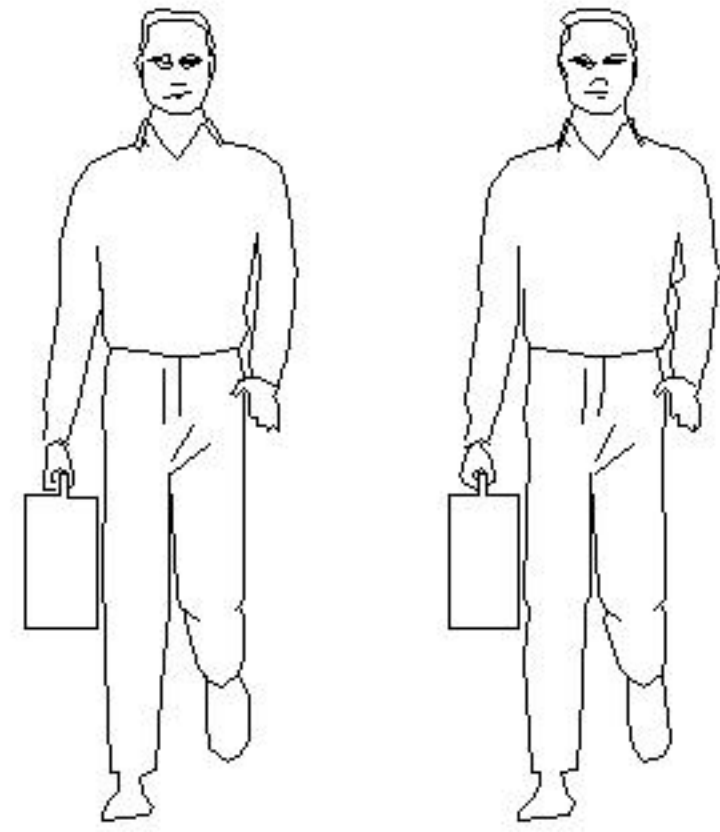



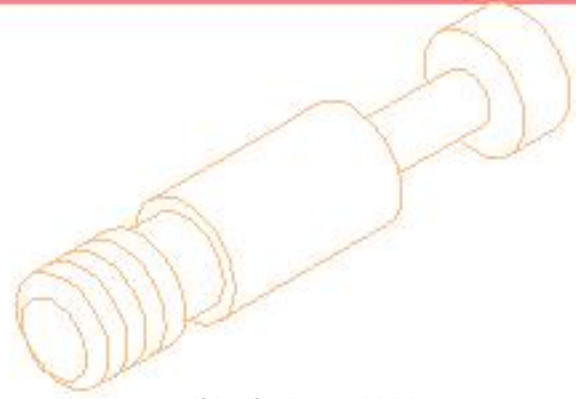

安装示意图/Assembly Instruction

产品名称 Model NO.	OV1X-A 0.59M
产品规格 Specification	598*350*1800mm
安装工具 Tool	安装人数 Installer
	

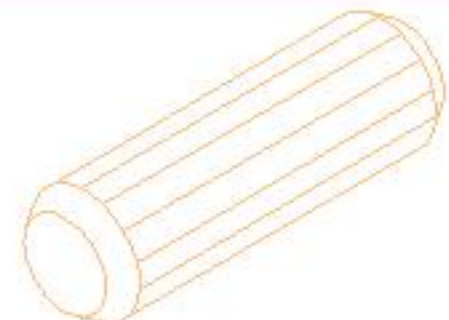
 (A)*18 大三合一锁饼 Three-in-one large lock	 (B)*18 二合一螺杆 2-in-1-screw	 (C)*8 脚垫-灰色毛毡 Grey felt pad	 (D)*25 木榫 \varnothing 8*30 Wood tenon
 (E)*13 背板扣 Back Panel Buckle	 (F)*13 自攻螺丝M3.5x16mm Self-tapping screw	 (G)*8 层板托5mm shelf support	 (H)*2 家具防倒器-白色 Anti-fall device
 (I)*2 夹板条-L=565 Brown splint strip			

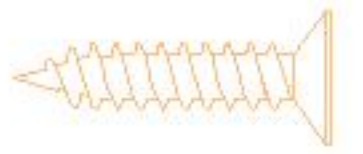
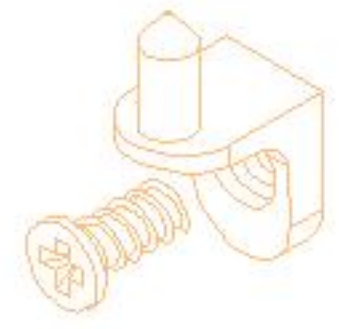
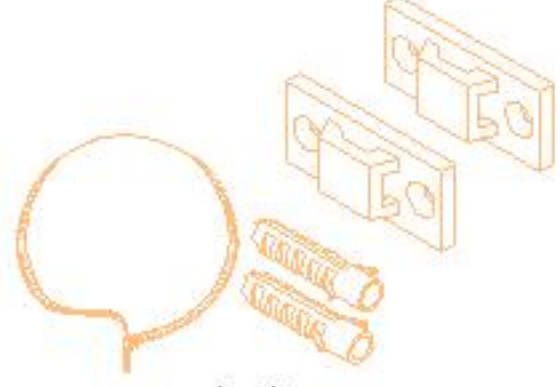
编号NO.	名称 Name	规格 (mm) Specification	数量QTY	材质 Material
1	左侧板Side board(L)	1785*350*15	1	三胺板 Melamine
2	右侧板Side board(R)	1785*350*15	1	三胺板 Melamine
3	顶板Top board	598*350*15	1	三胺板 Melamine
4	底板Bottom board	566*350*15	1	三胺板 Melamine
5	上层板Upper shelf	566*350*15	1	三胺板 Melamine
6	中层板Middle shelf	566*350*15	1	三胺板 Melamine
7	下层板Lower shelf	566*350*15	1	三胺板 Melamine
8	上隔板Upper clapboard	300*333*15	2	三胺板 Melamine
9	上活动层板Upper movable shelf	565*114*15	1	三胺板 Melamine
10	下活动层板Down movable shelf	565*327*15	1	三胺板 Melamine
11	大层板Big shelf	566*320*25	1	三胺板 Melamine
12	底拉条Bottom brace	566*58*15	2	三胺板 Melamine
13	上背板Upper back board	300*566*15	1	三胺板 Melamine
14	中背板Middle back board	146*566*15	1	三胺板 Melamine
15	背板1 Back board 1	310*576*5	1	三胺板 Melamine
16	背板2 Back board 2	192*576*5	2	三胺板 Melamine
17	下背板Lower back board	265*576*5	2	三胺板 Melamine

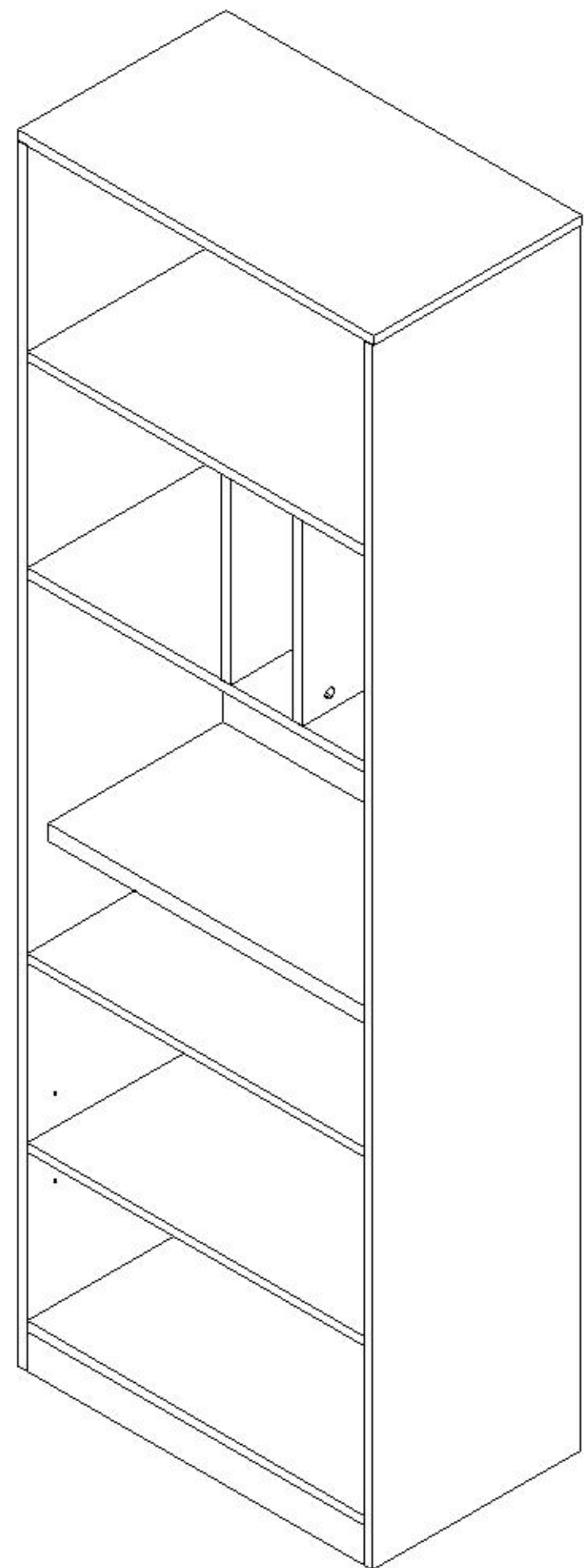

OV1X-A 0.59M

安装方法/
Installation method

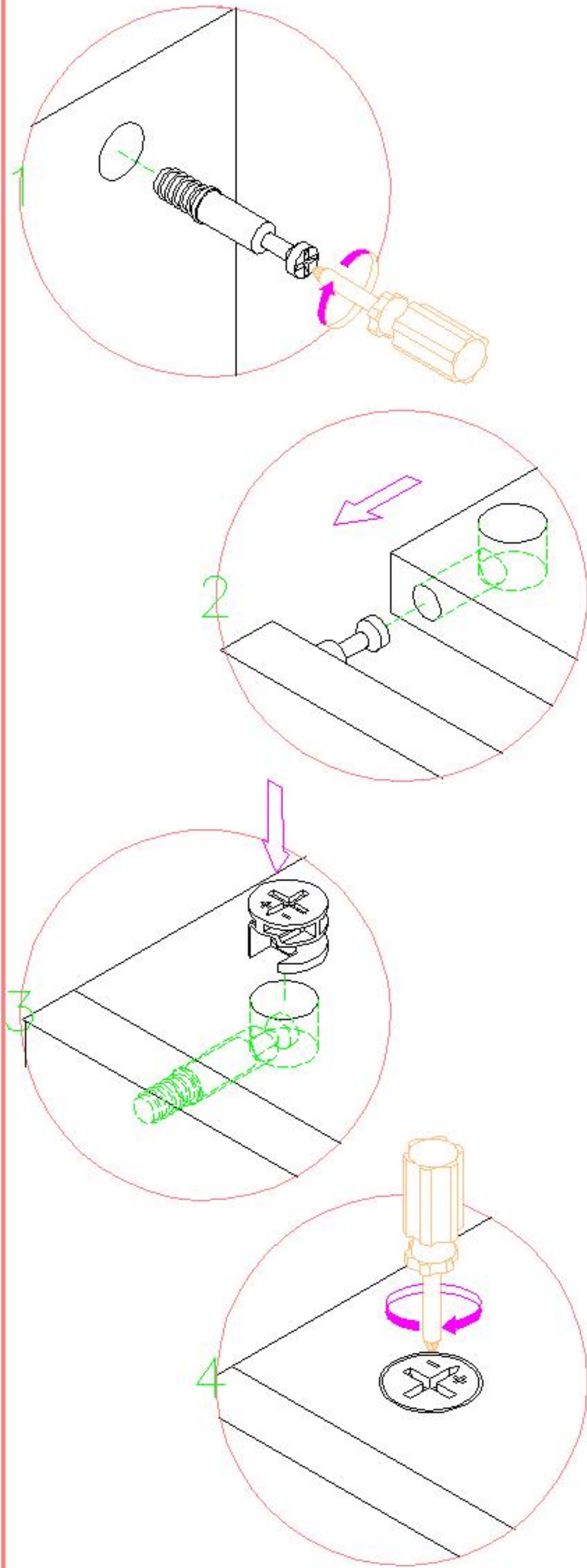

大二合一
two-in-one

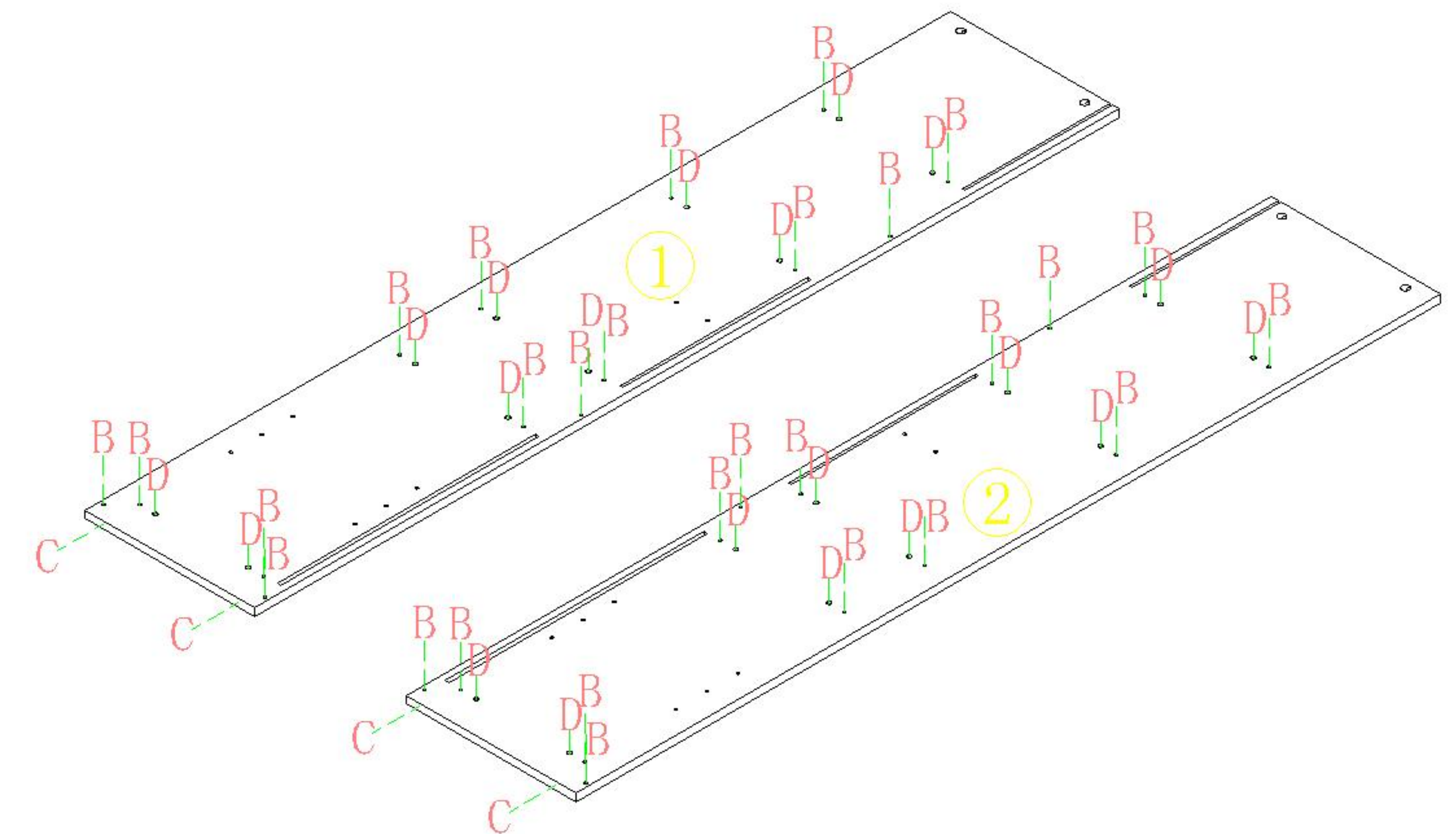
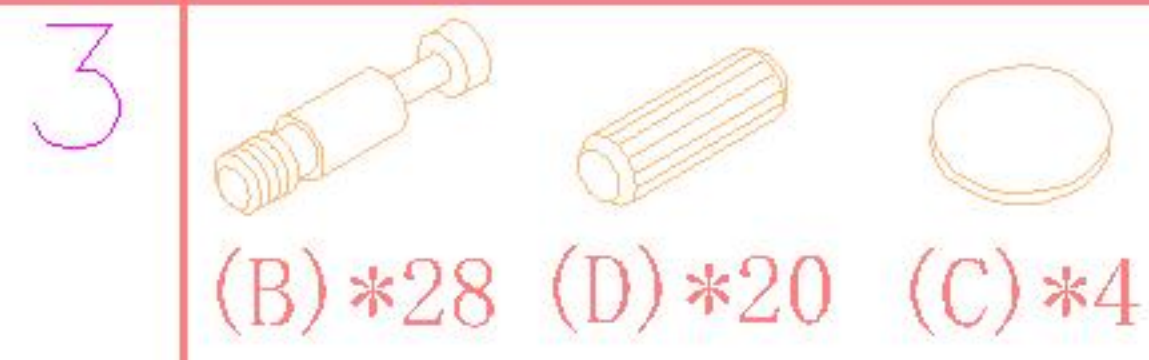
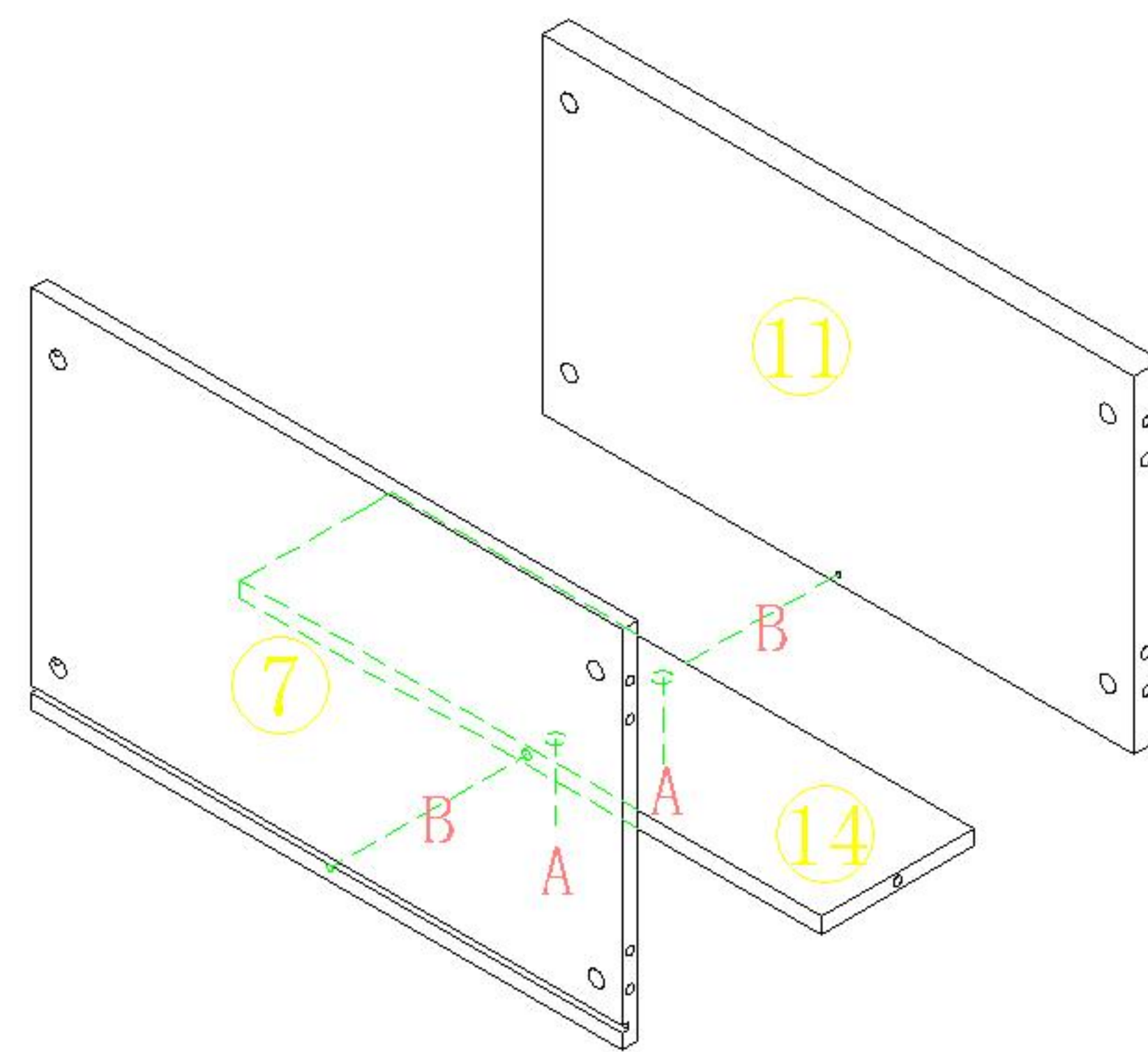
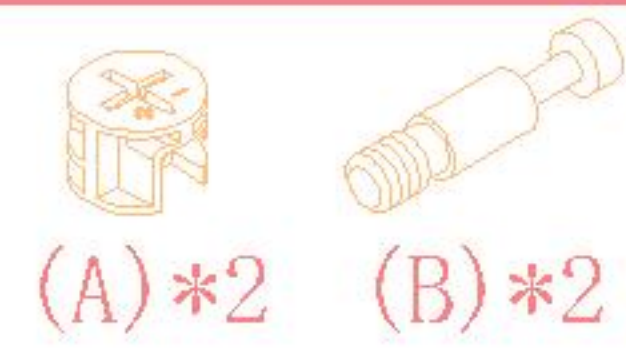
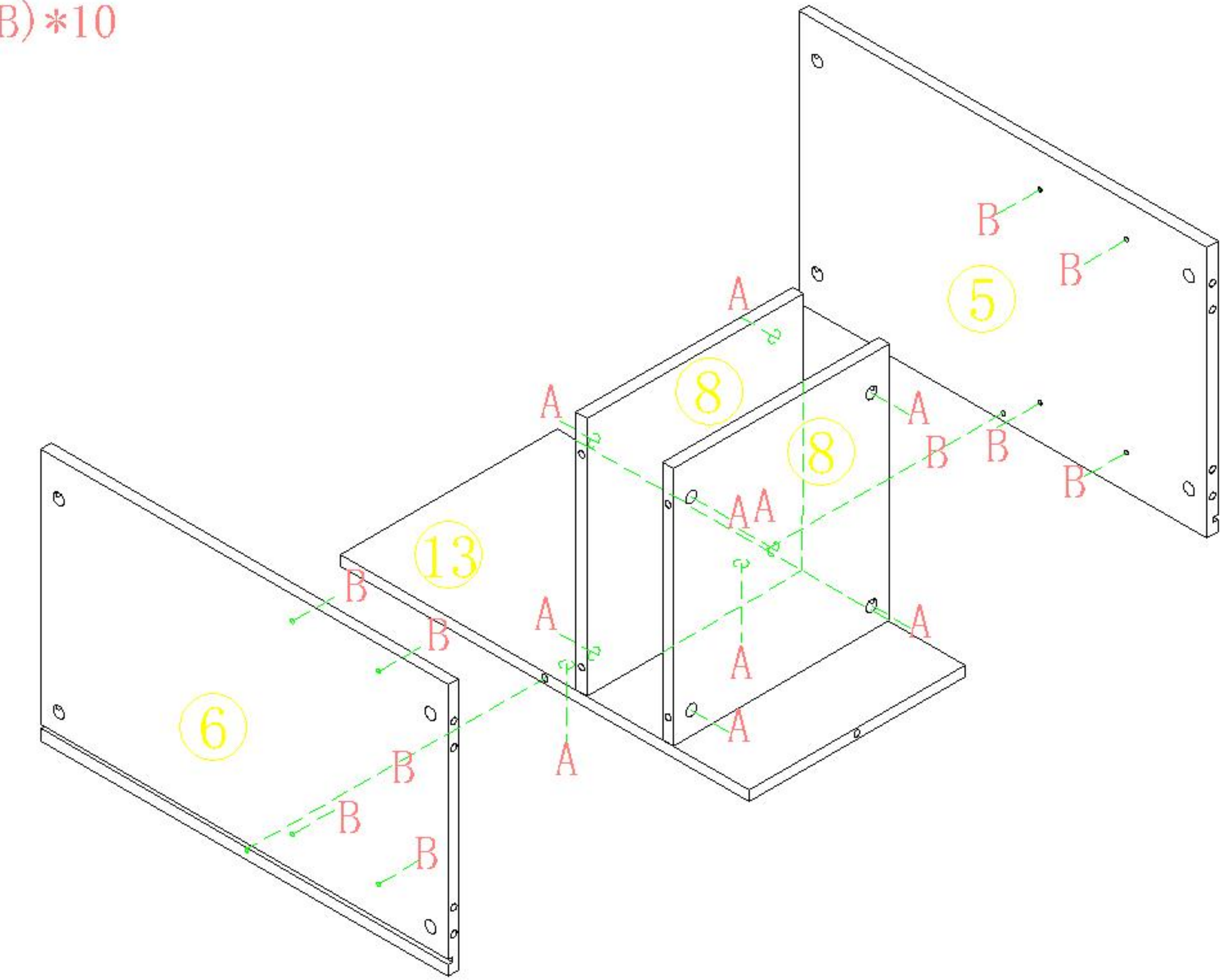
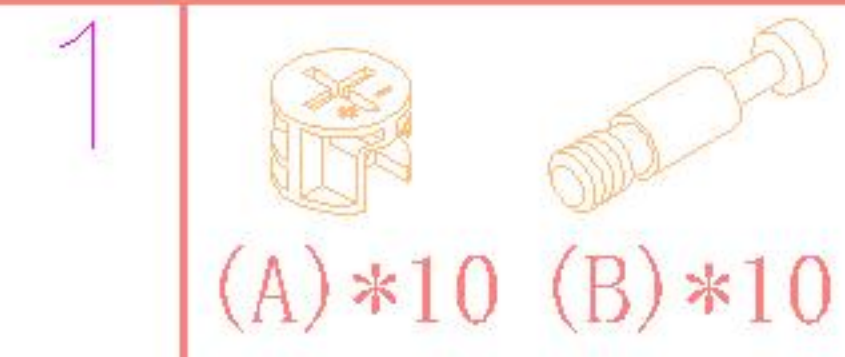
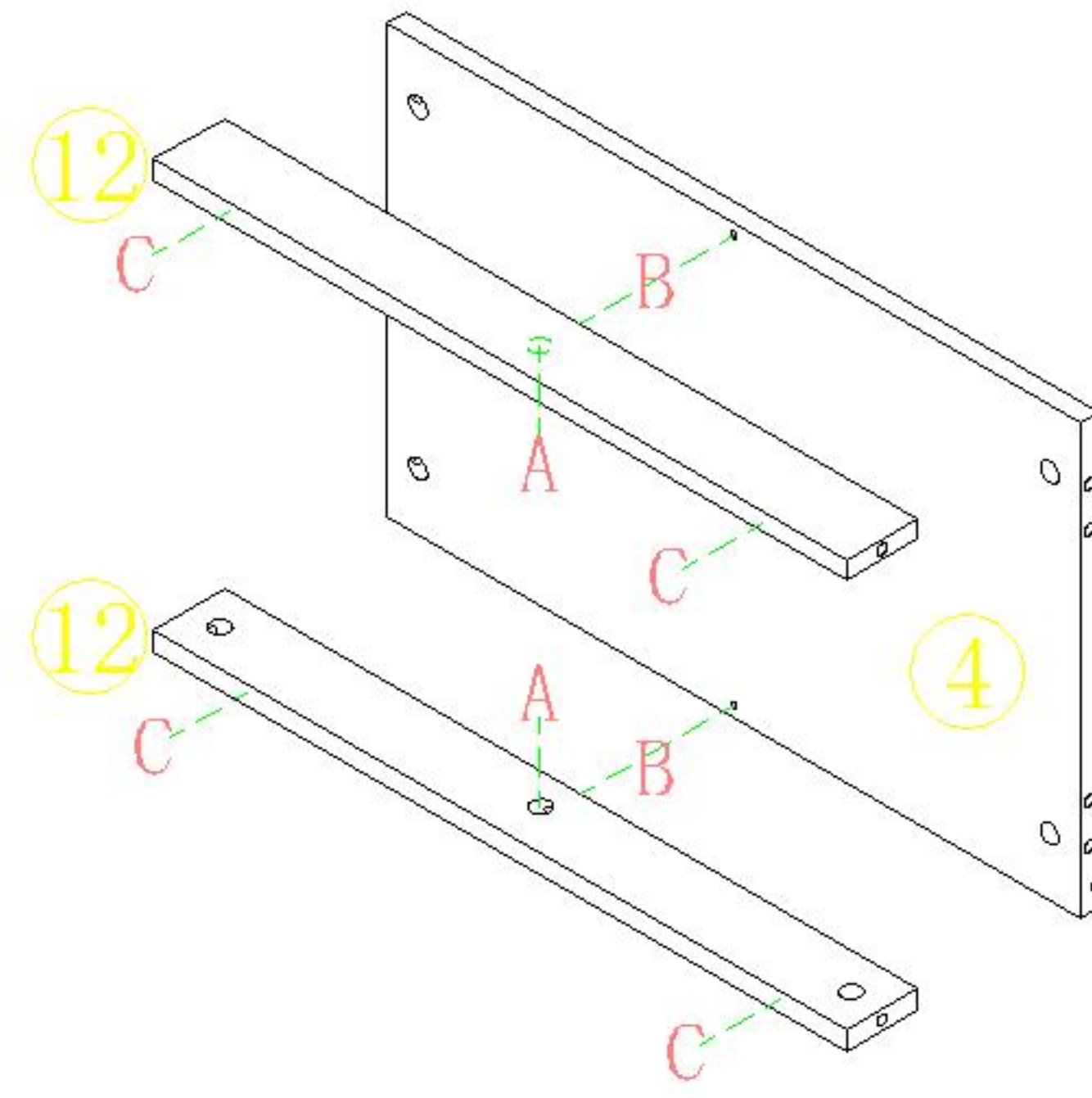

安装方法/
Installation method

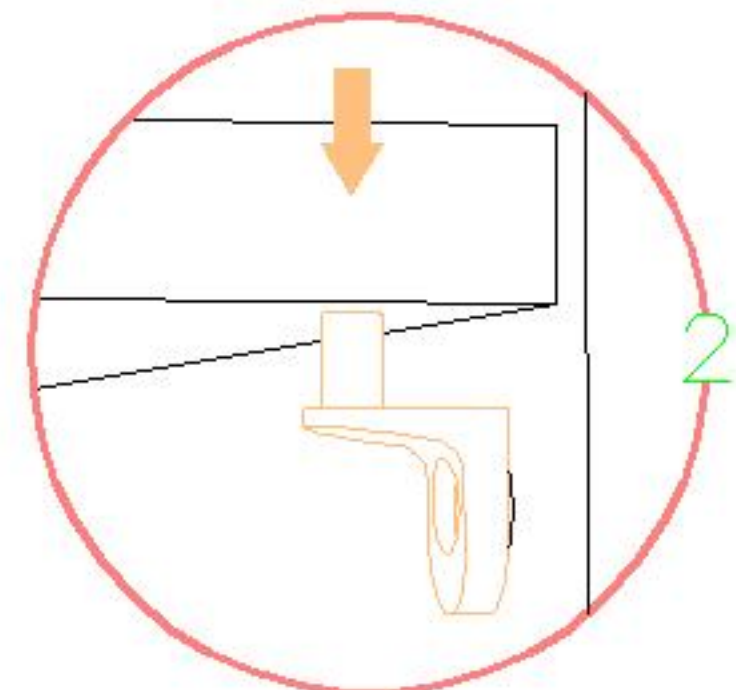
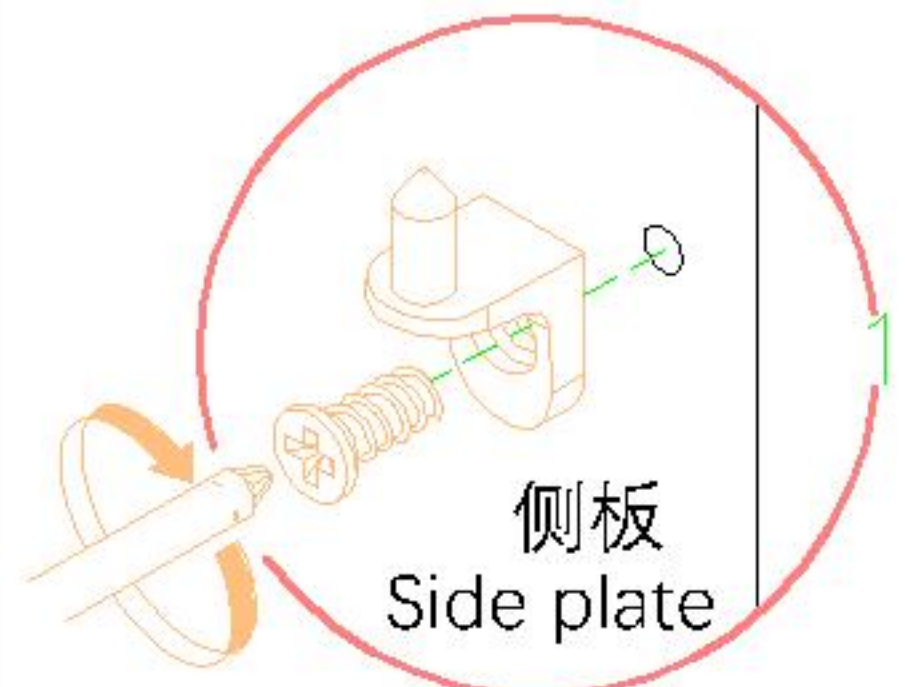

(A)*14

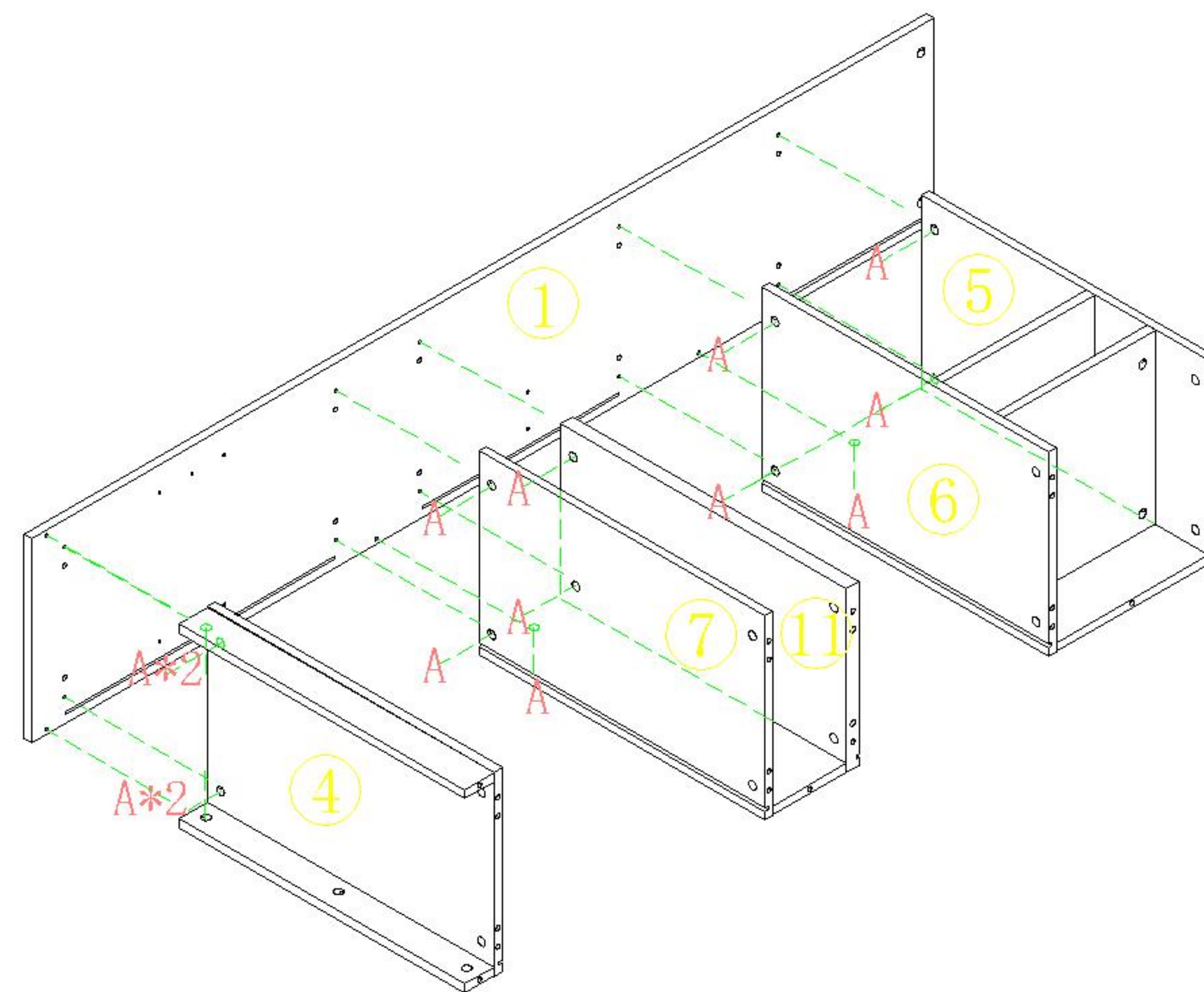

5



(A)*14



(I)*2

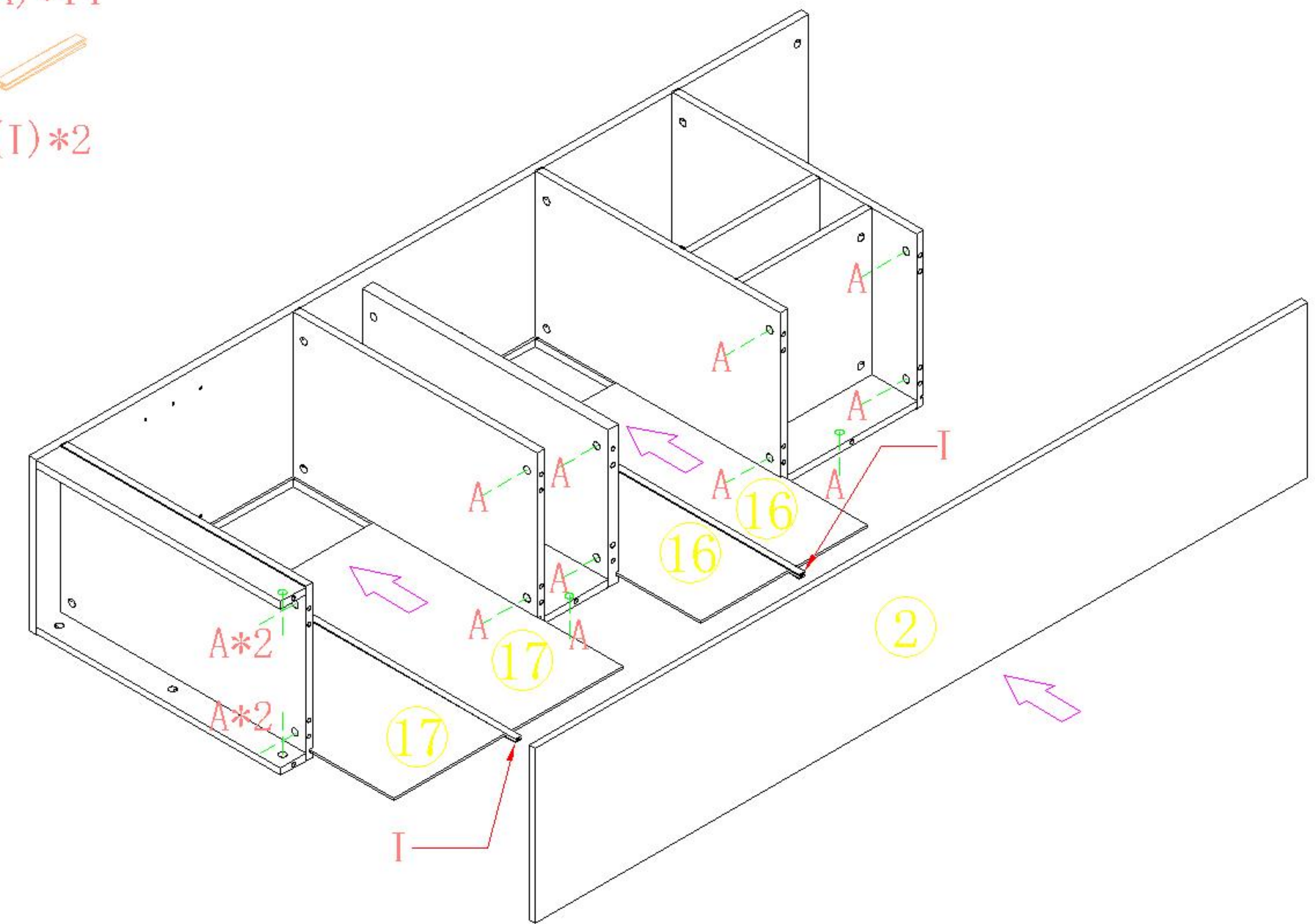

6



(A)*4



(B)*4



(D)*4

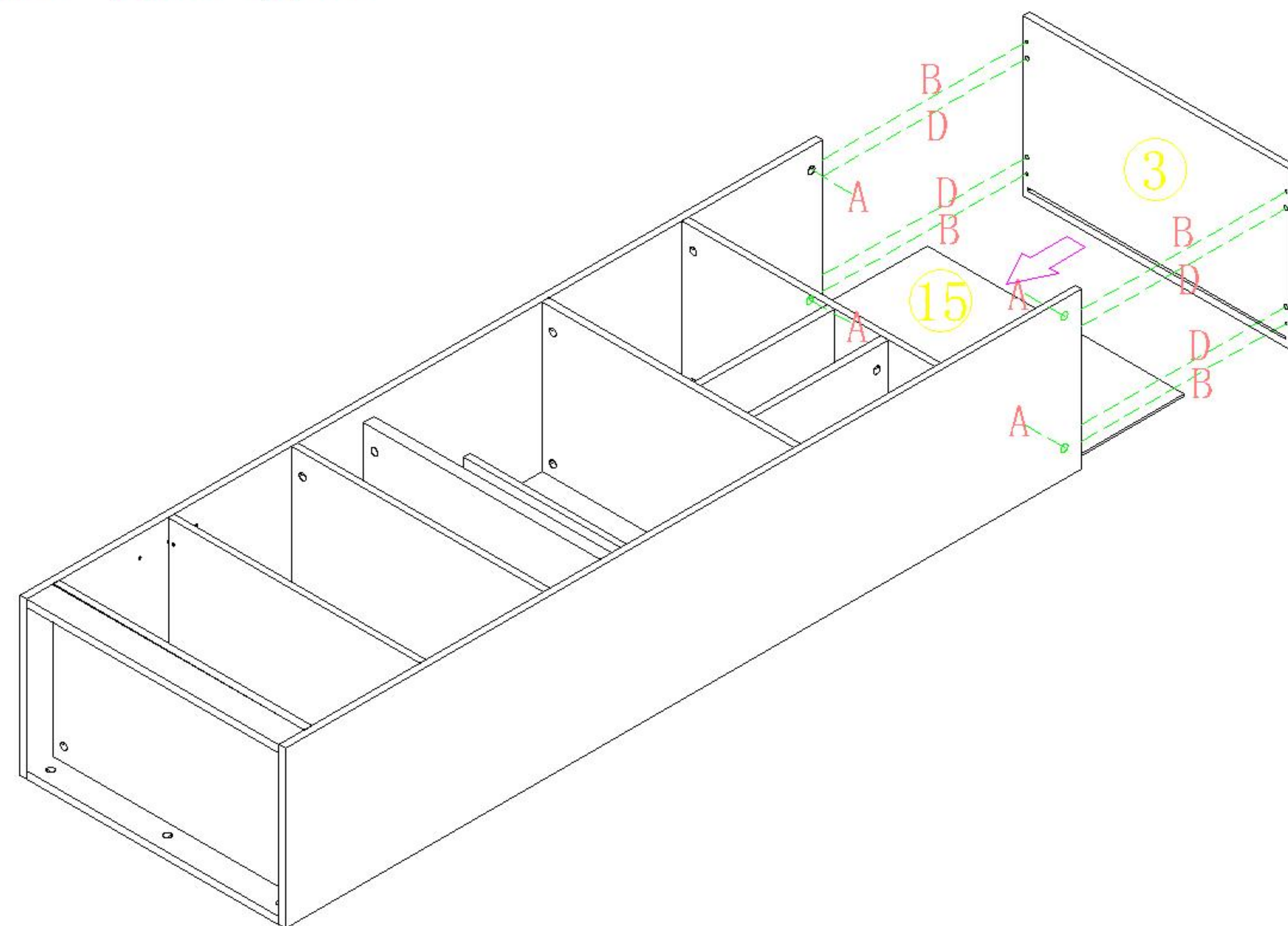

7



(G)*8

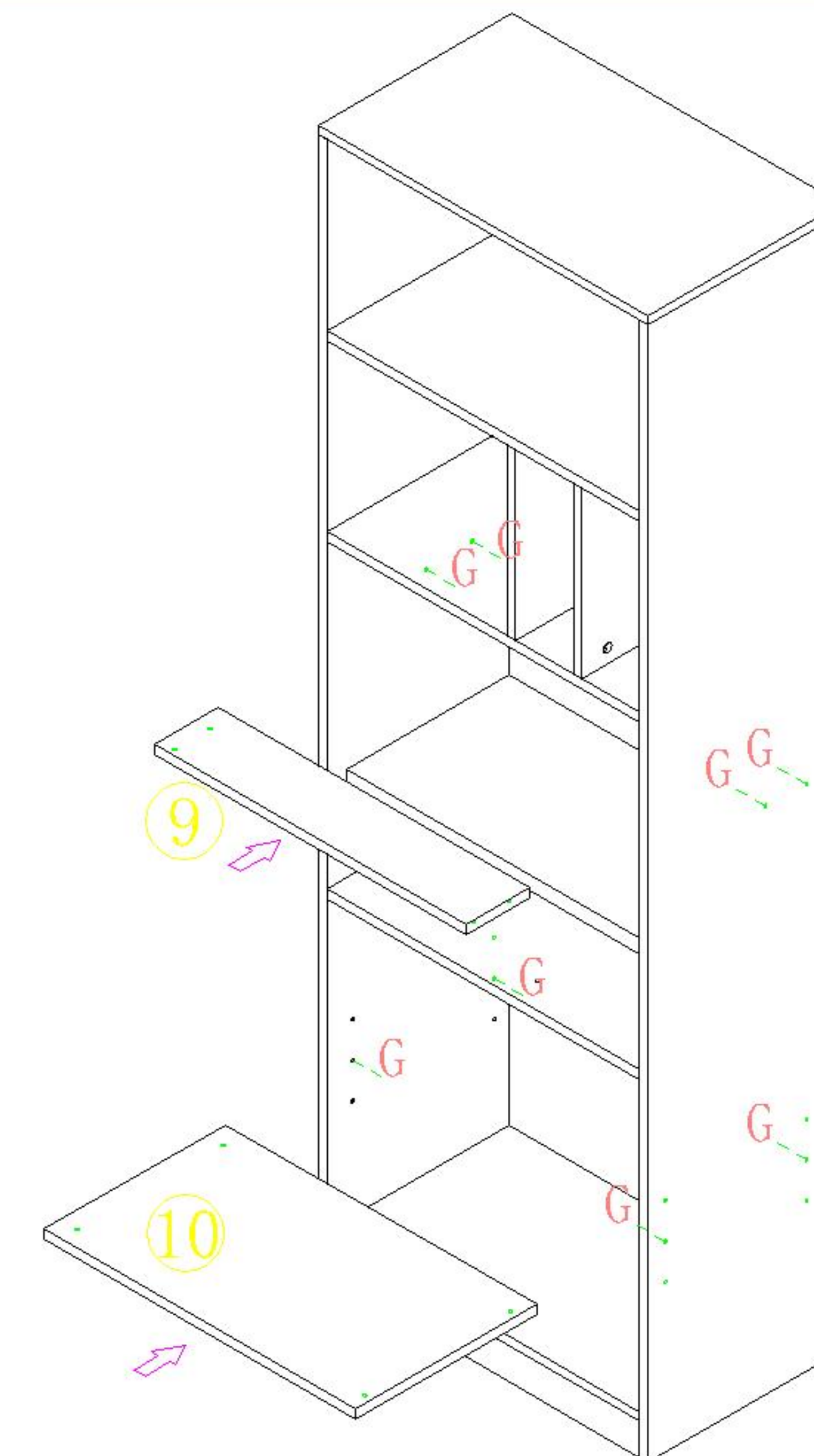

8



(E)*12



(F)*12

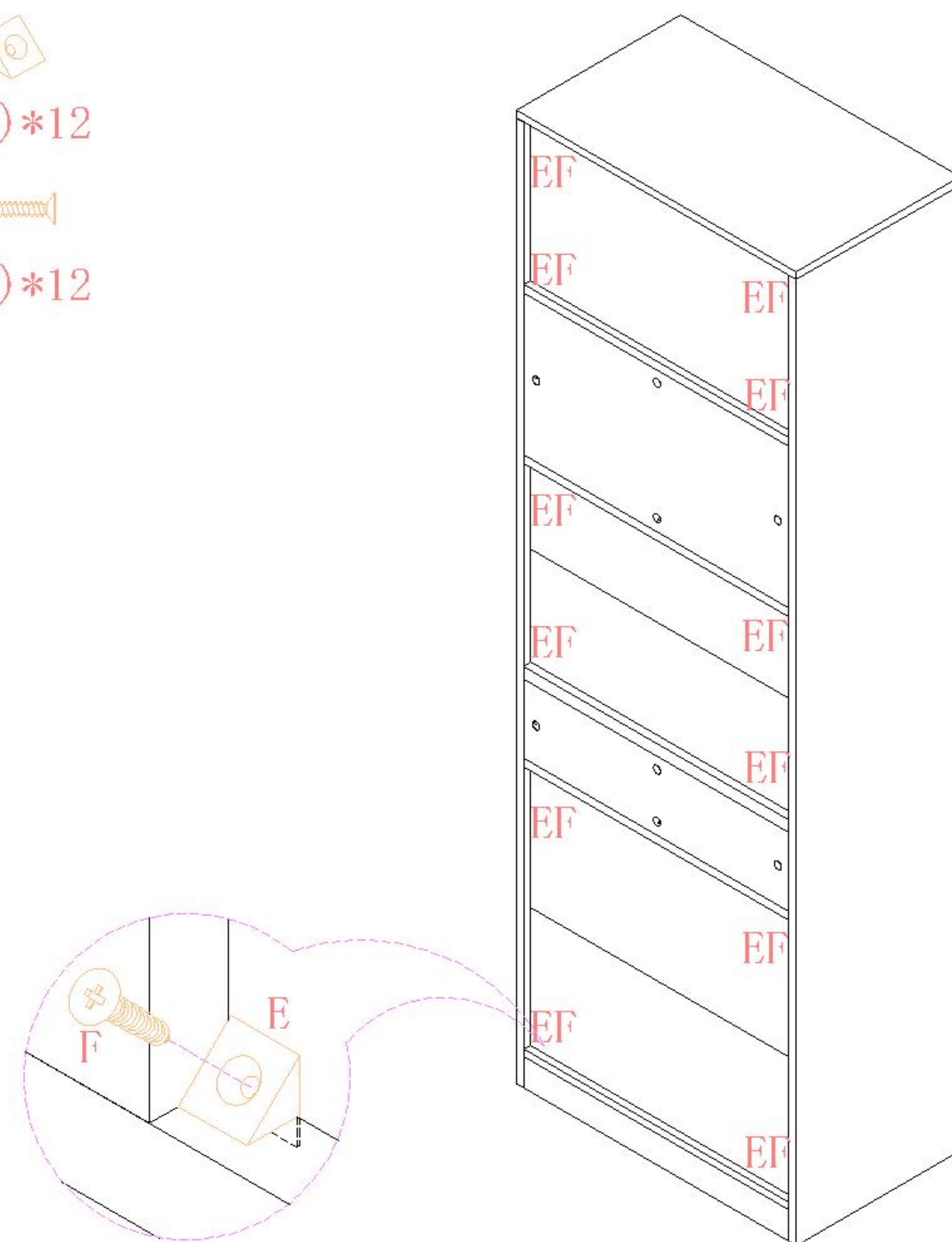

(H)*2

实体墙
Solid wall

