

OXFORD

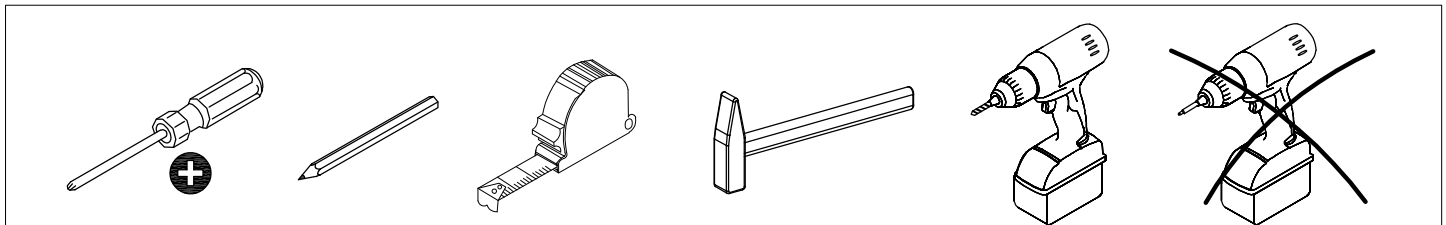

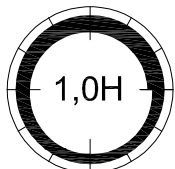

			✓
①	3	800x300x18	
②	3	630x400x18	
③	4	885x176x30	

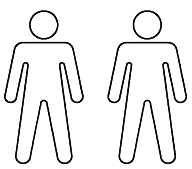
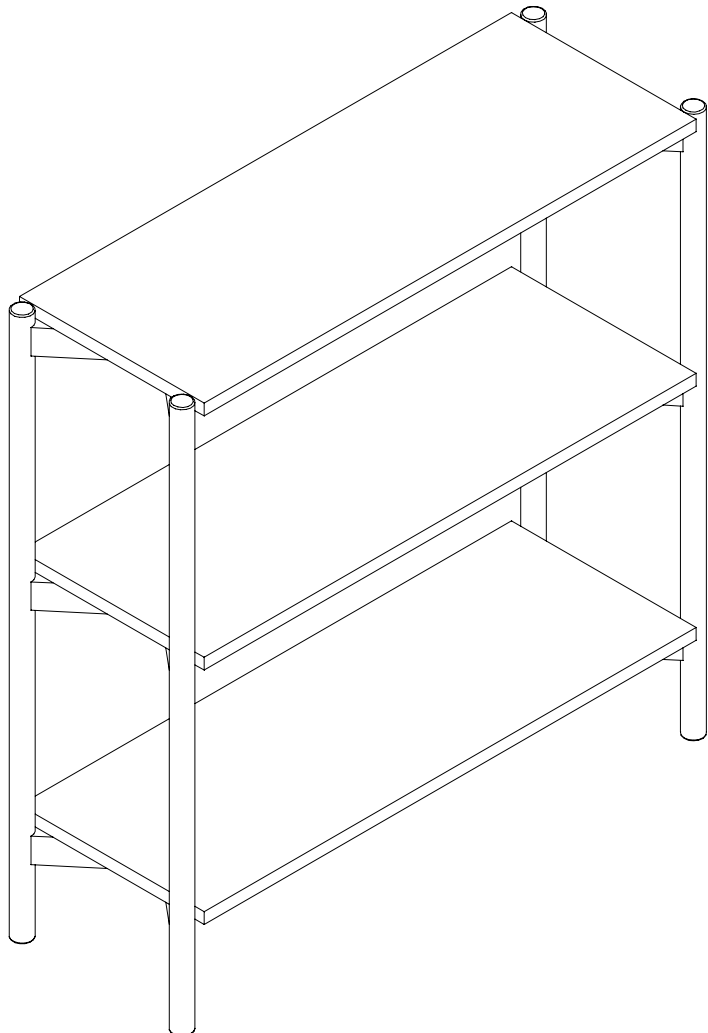
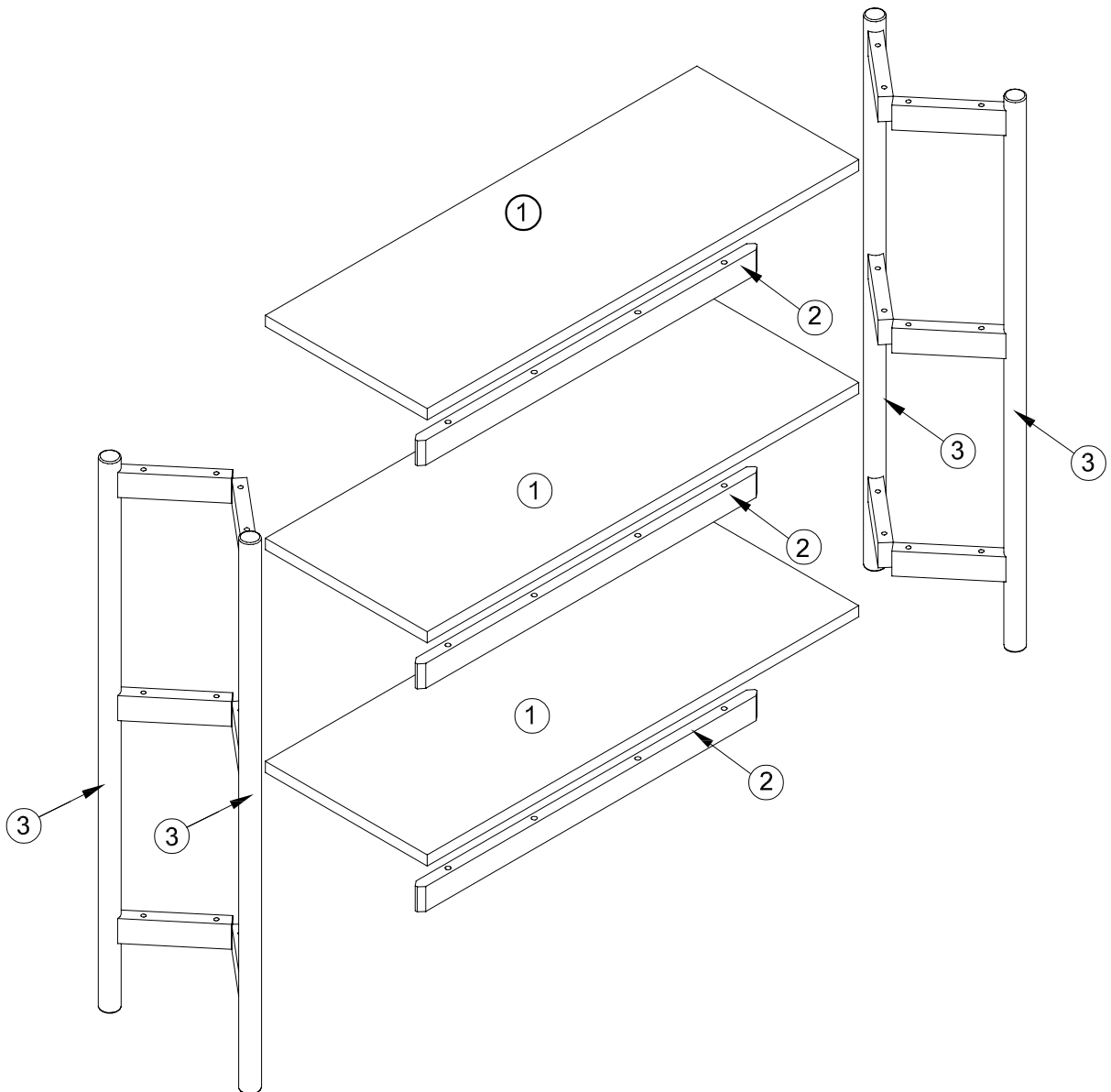
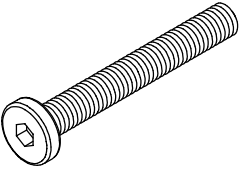
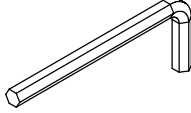
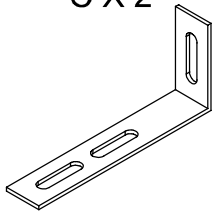
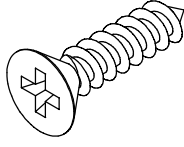
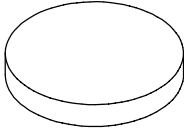
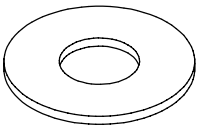

<p>A X 36</p>  <p>M6X45 mm</p>	<p>B X 1</p>  <p>4 mm</p>	<p>C X 2</p>  <p>85X30X15 mm</p>	<p>D X 4</p>  <p>Ø3.5X14 mm</p>	<p>E X 4</p>  <p>Ø25X3 mm</p>
<p>F X 12</p>  <p>Ø6/Ø12 mm</p>				

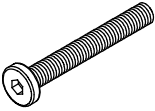
1

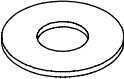
A X 12  M6X45 mm	B X 1  4 mm	F X 12  Ø6/Ø12 mm
---	--	--

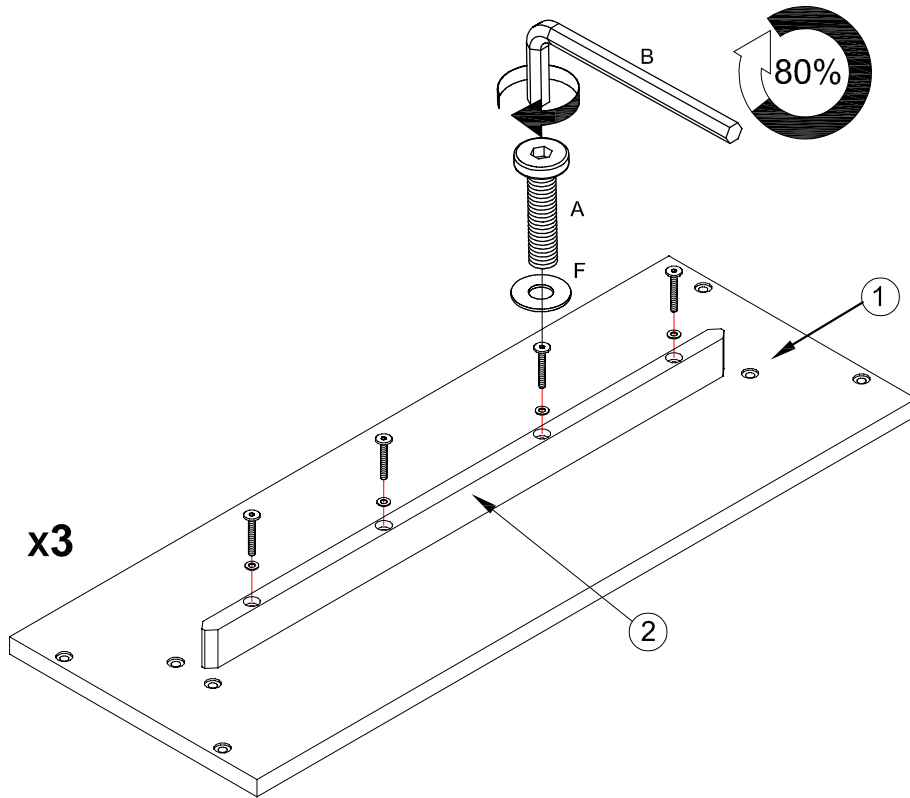

2

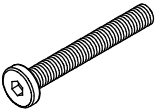
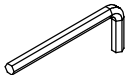
A X 12  M6X45 mm	B X 1  4 mm
---	--

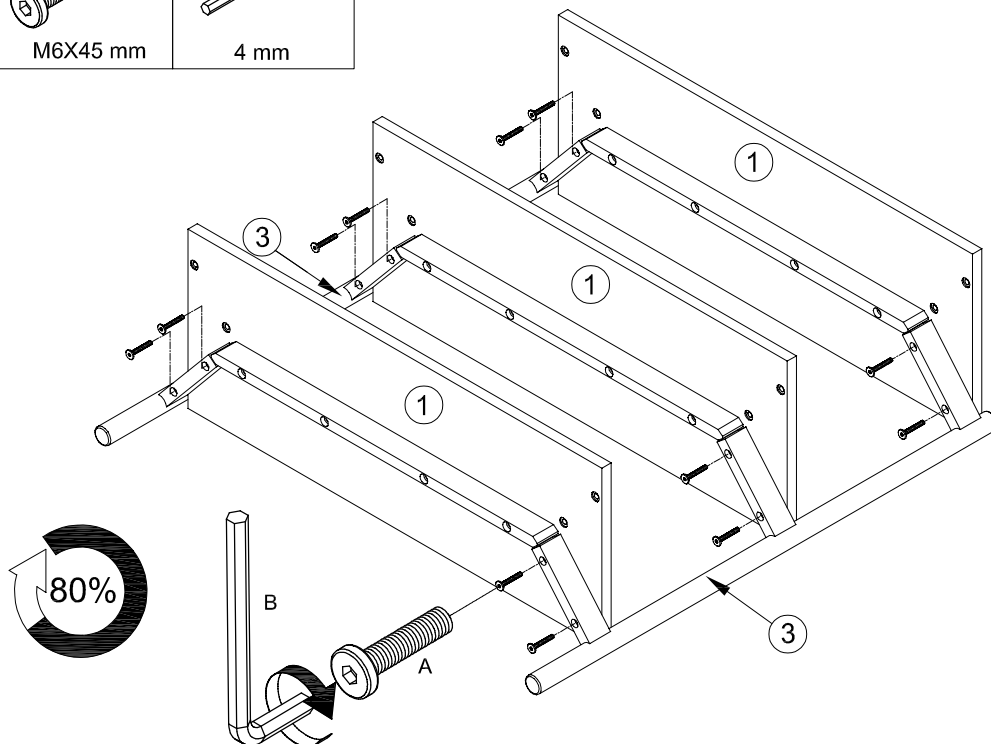

3

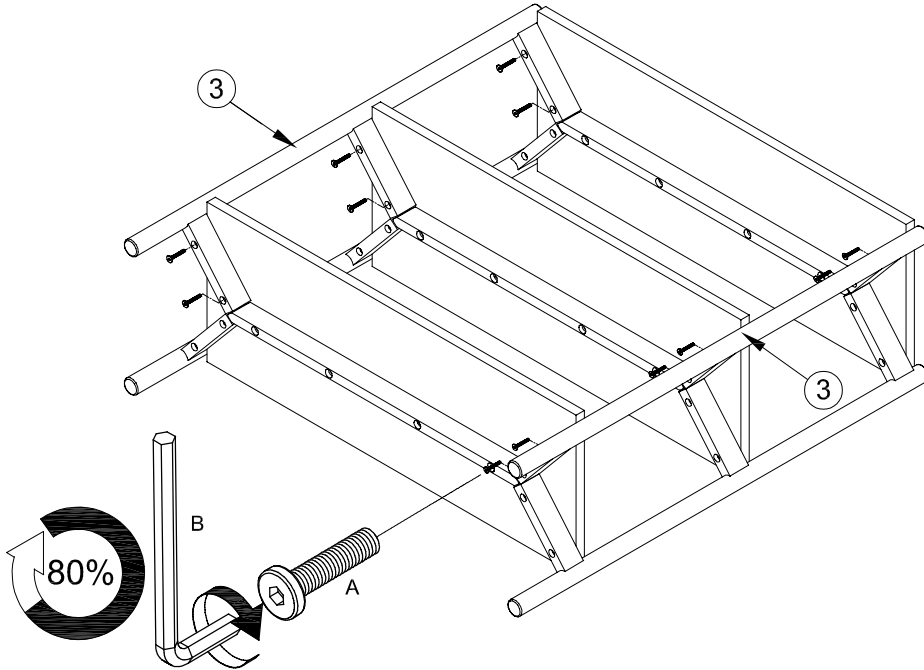
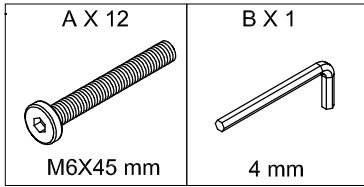

4

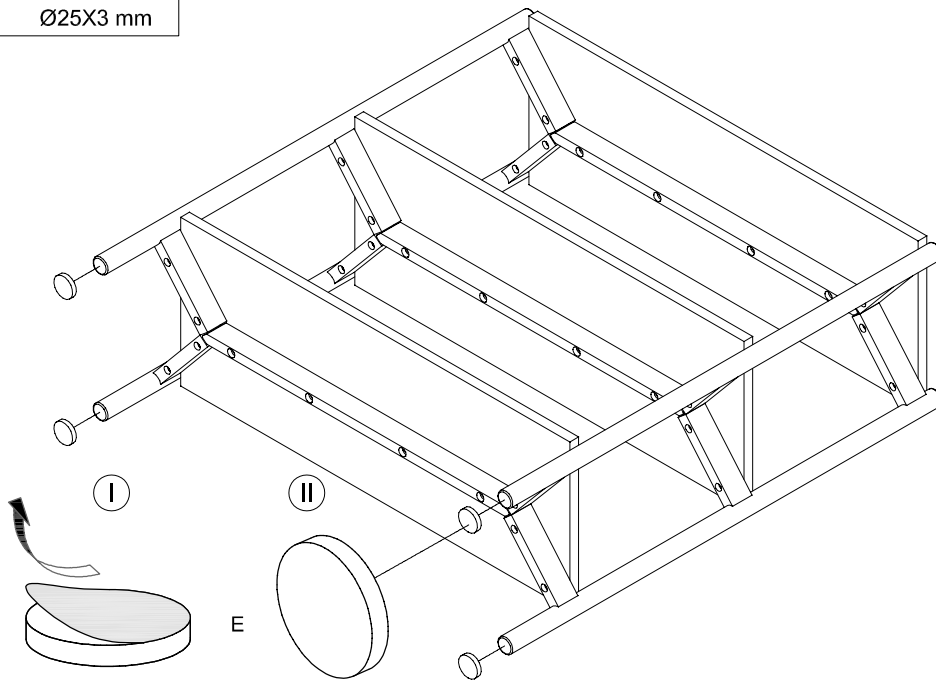
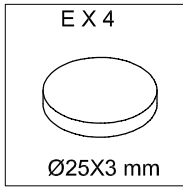

5

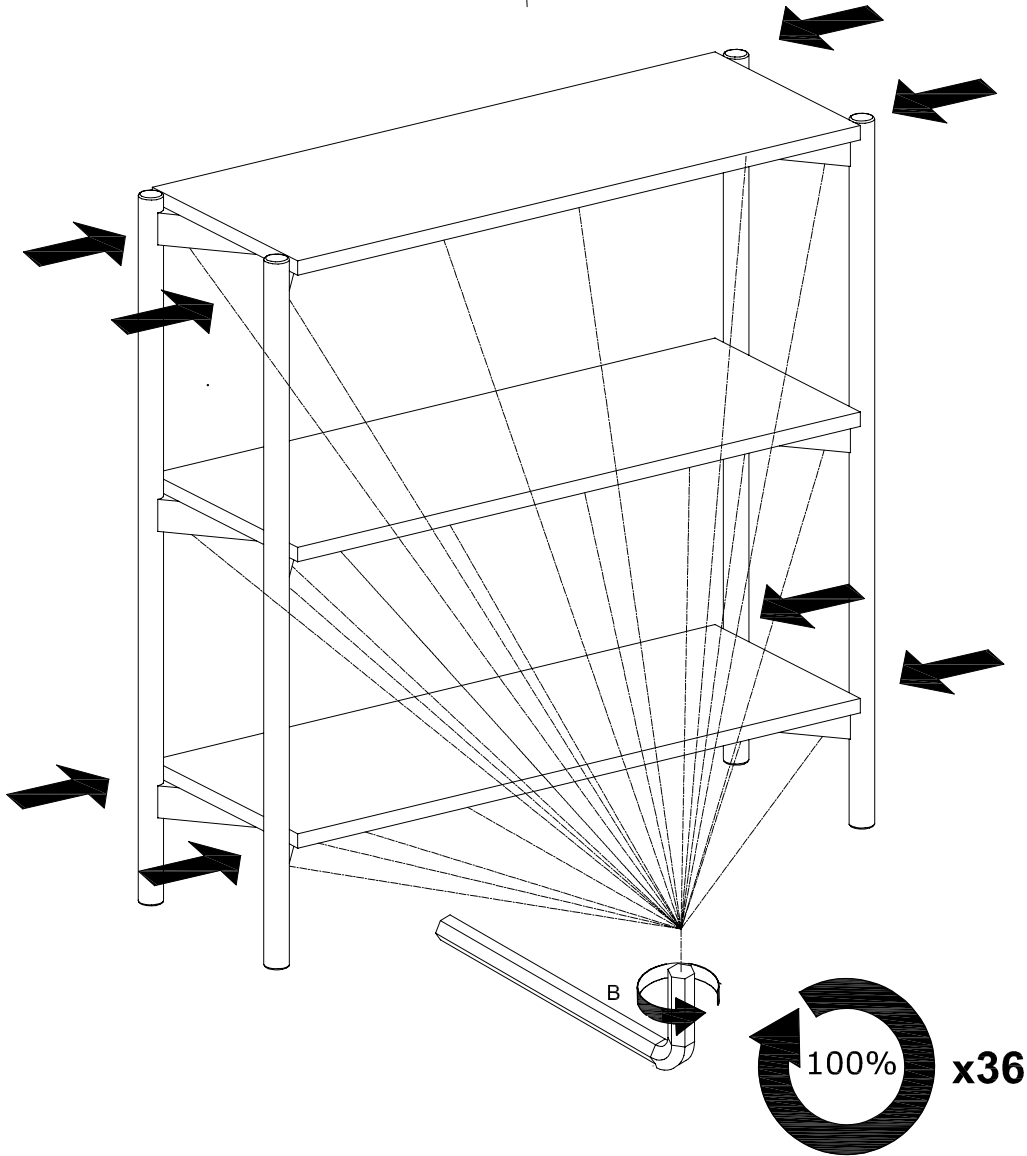
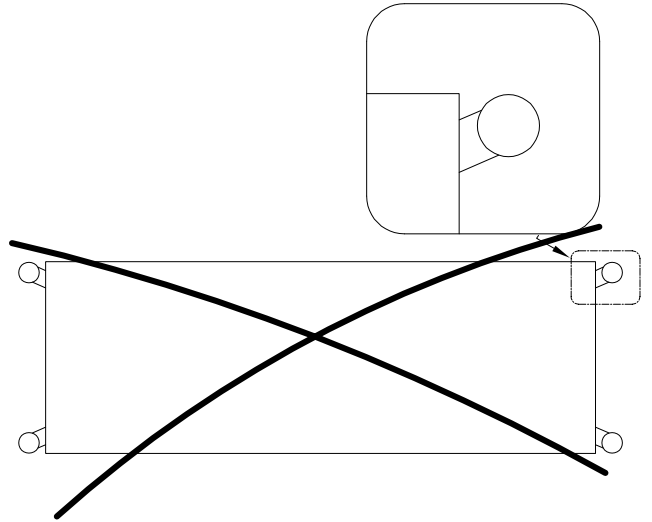
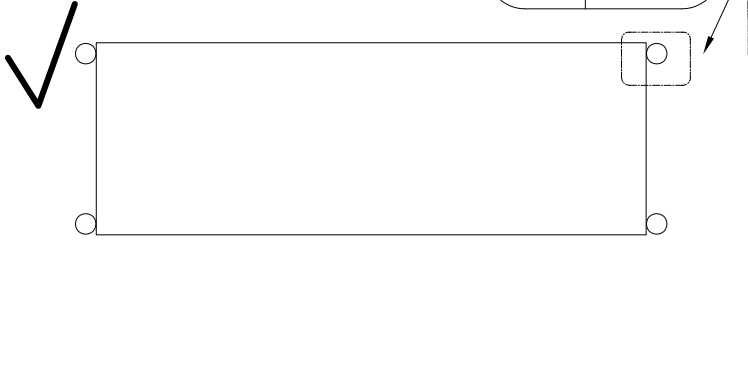
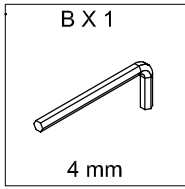

6

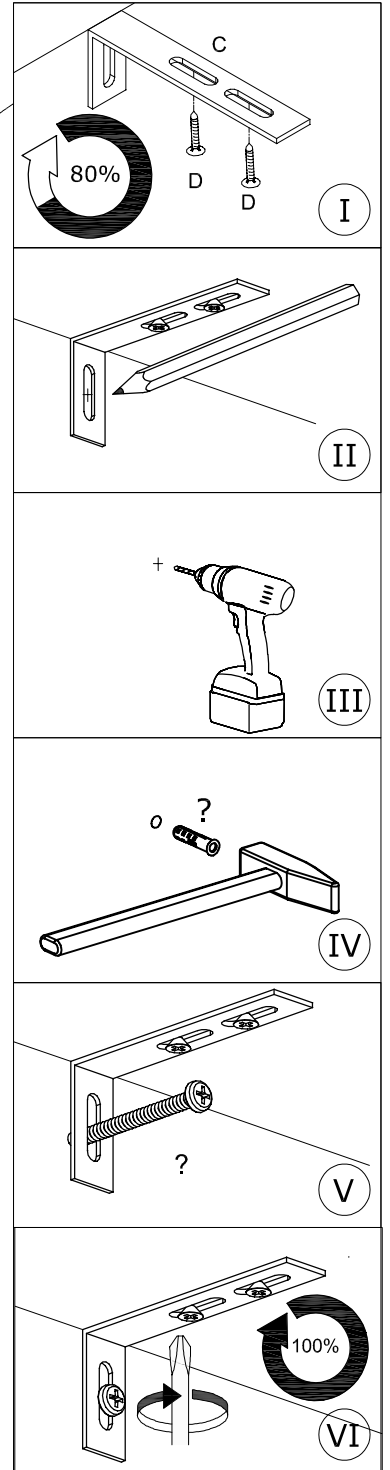
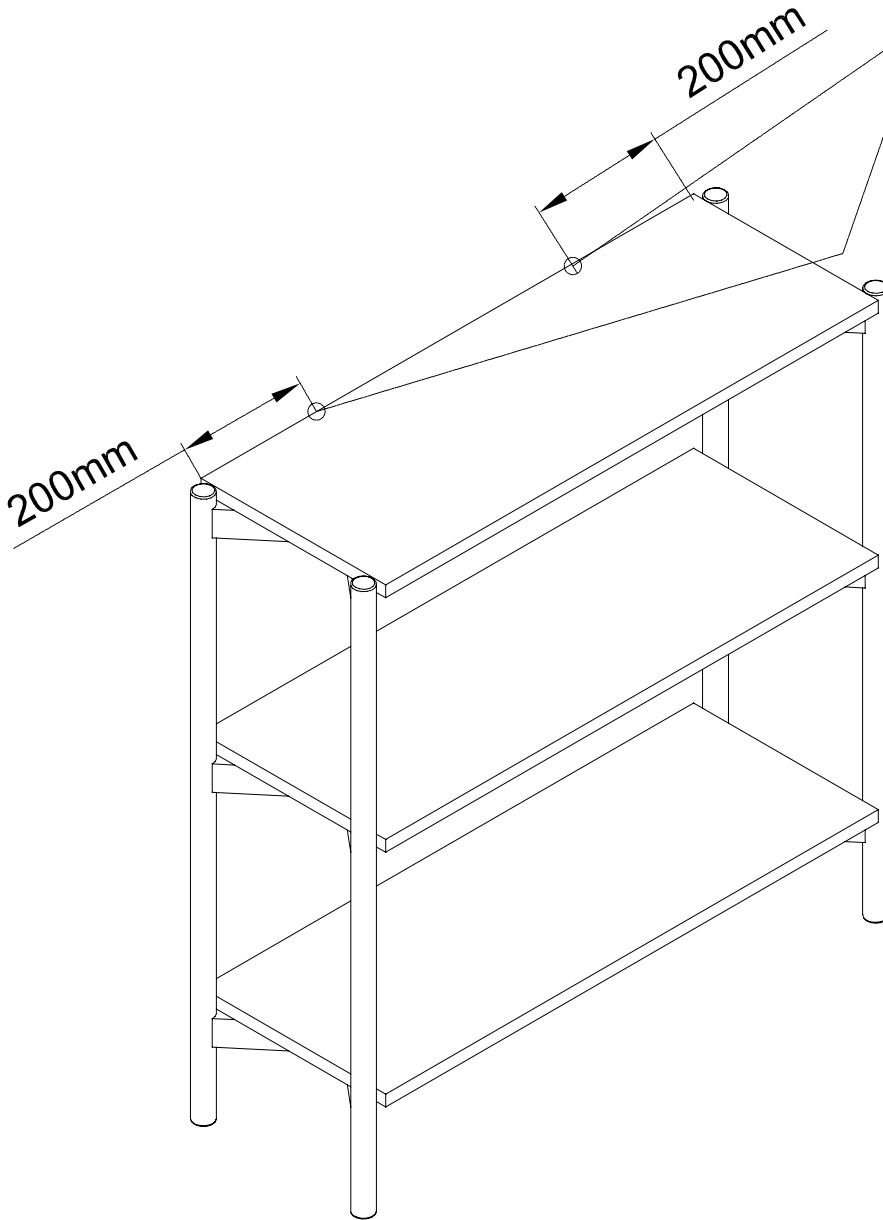
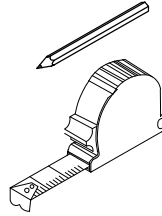
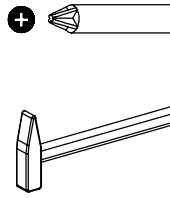
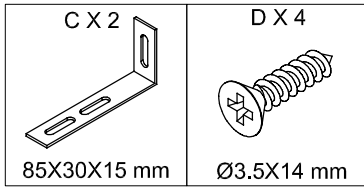

7

