

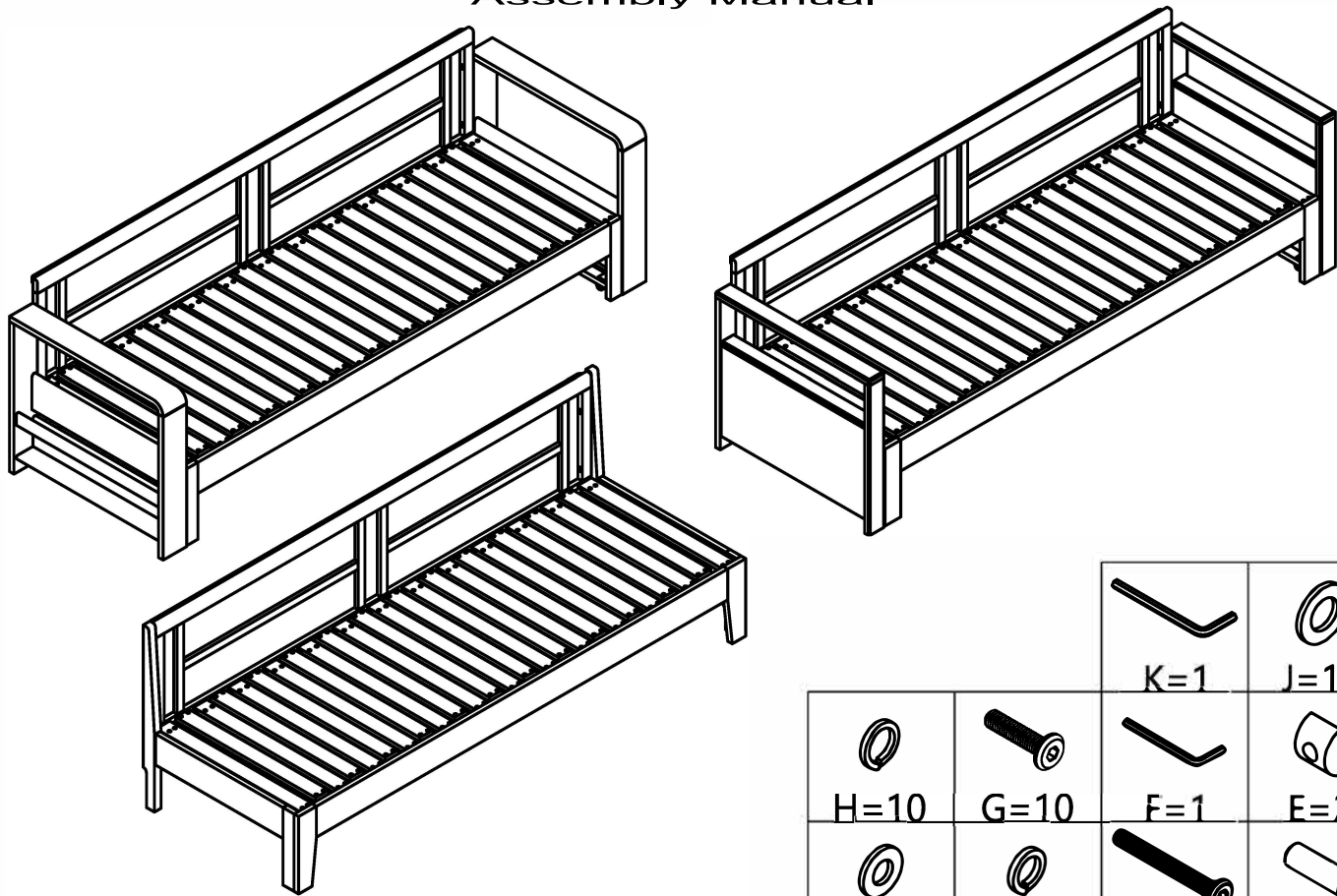







组装说明书

Assembly Manual



			
H=10	G=10	F=1	E=2
			
D=2	C=2	B=2	A=4

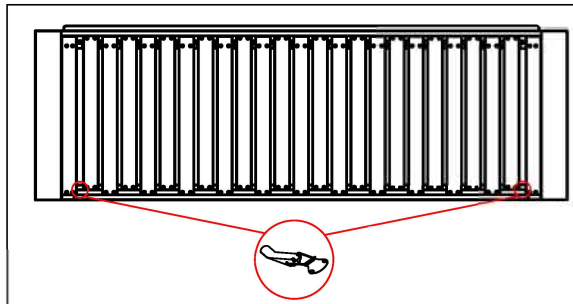
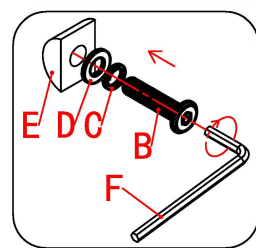
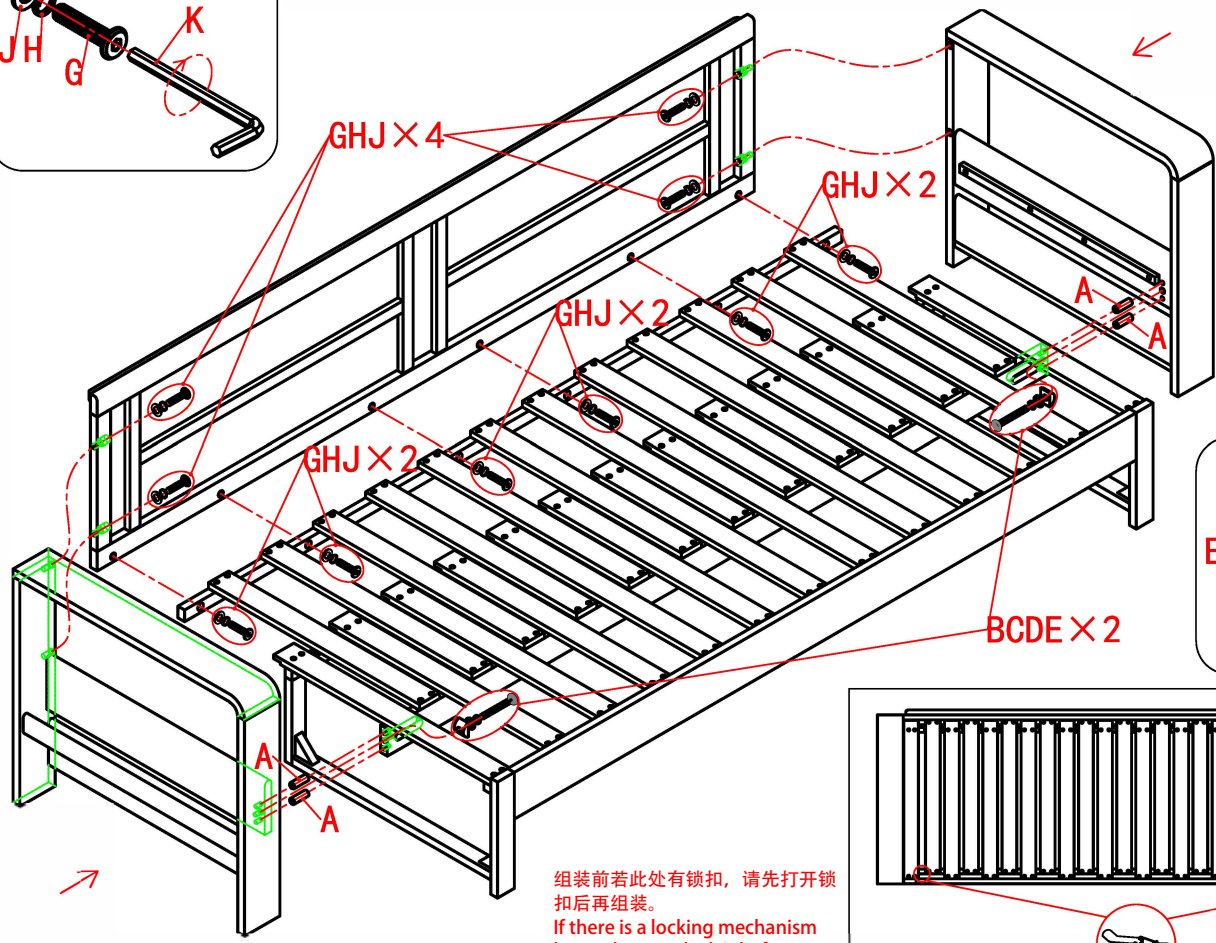
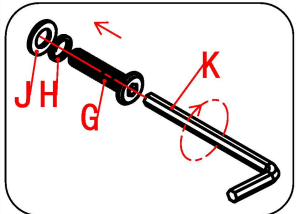

组装前若此处有锁扣，请先打开锁扣后再组装。
If there is a locking mechanism here, please unlock it before assembly.