

Assembly Instructions

Amber Sofa 170cm

Assembled Product Diagram:

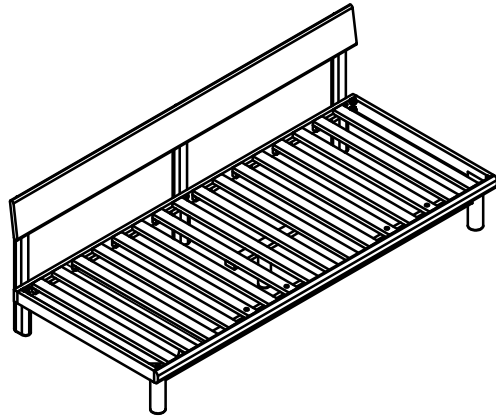

第一步：前腿框与坐框连接（中腿可旋转拧紧）

Step 1: Use the Allen wrench (D) to connect the front leg frame to the seat frame using screws (B), flat washers (A), and spring washers (C).

Note: The middle leg can be rotated and tightened securely.

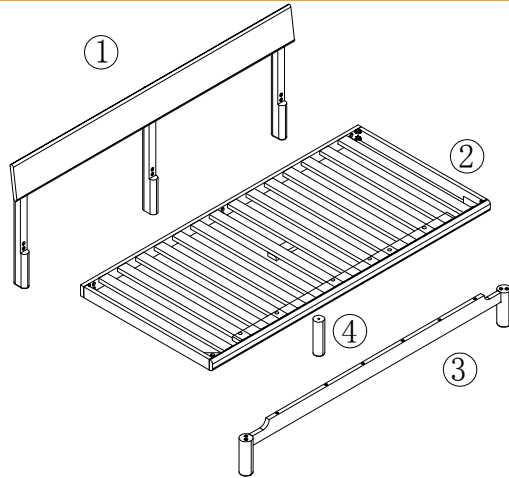
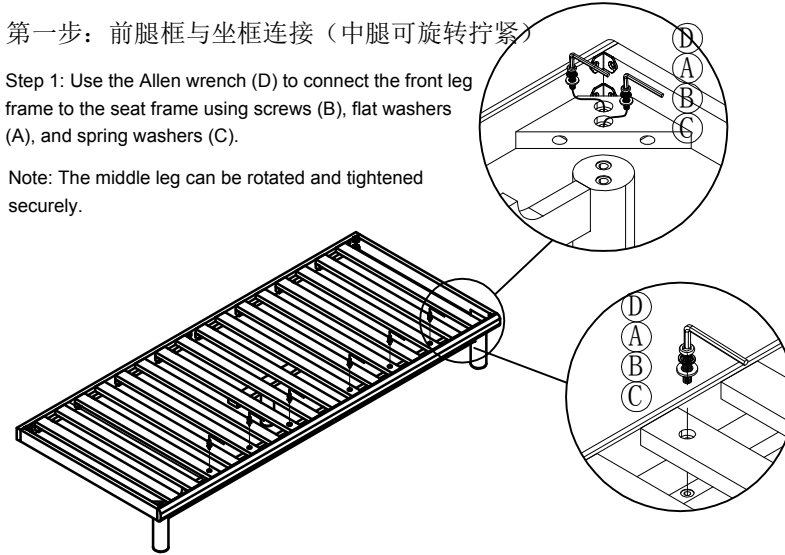

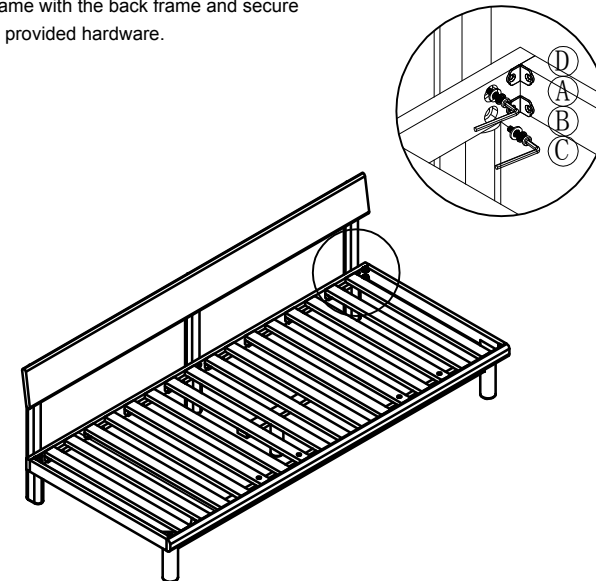

第二步：坐框与背框连接

Step 2: Align the seat frame with the back frame and secure them together using the provided hardware.

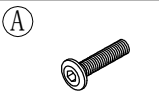

Hardware List:

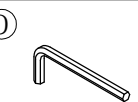
			
Screws=16	Spring Washers=16	Flat Washers=16	Allen Wrench=1