

# Assembly Instructions

## Mio Kids Toy Storage Combination with 6 Boxes

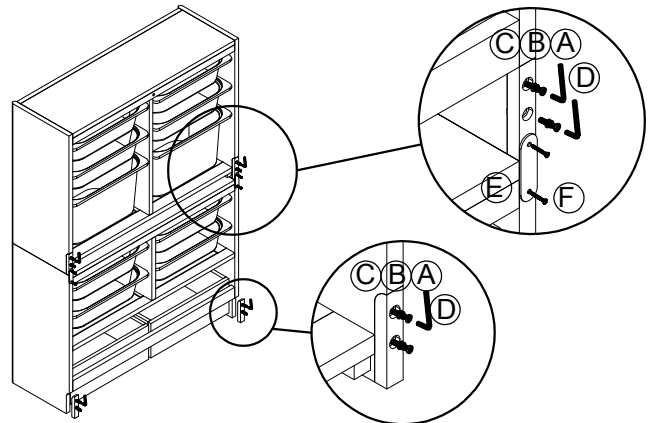

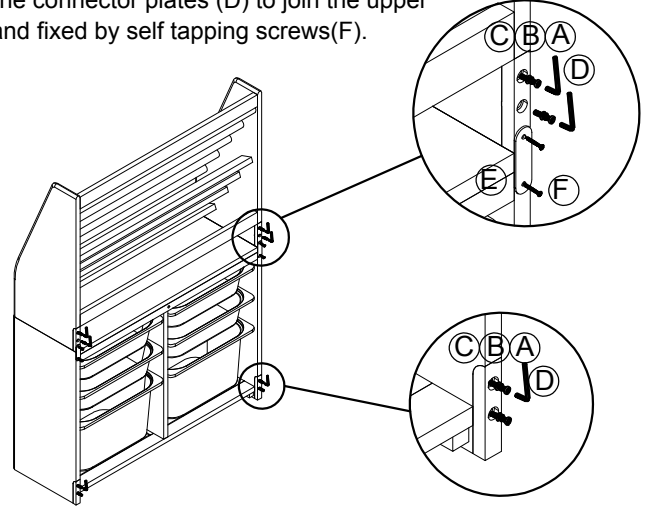

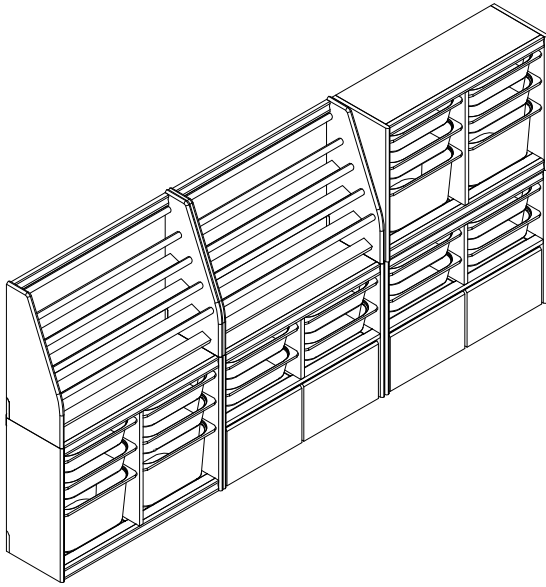

1. Install the Kickboard: Attach the removable kickboard using the screws (A), flat washers (B), and spring washers (C). Secure it with the Allen wrench (D).

2. Connect Upper and Lower Sections: Use the connector plates (E) to join the upper and lower parts of the storage unit securely and fixed by self tapping screws(F).



Note: The kickboard installation is optional and can be done based on your preference.

### Hardware List:

<p><b>A</b></p> 	<p><b>B</b></p> 	<p><b>C</b></p> 	<p><b>D</b></p> 	<p><b>E</b></p> 	<p><b>F</b></p> 
Flat-Head Hex Screws=8	Spring Washers=4	Flat Washers=4	L-shaped Allen Wrench=1	Connector Plates=2	Self-Tapping Screws=4