

# Assembly Instructions

## Santa Rosa Coffee Table-Large

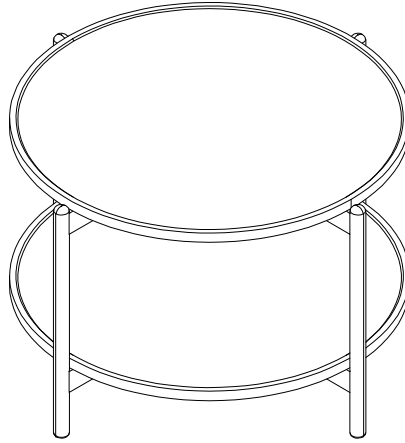





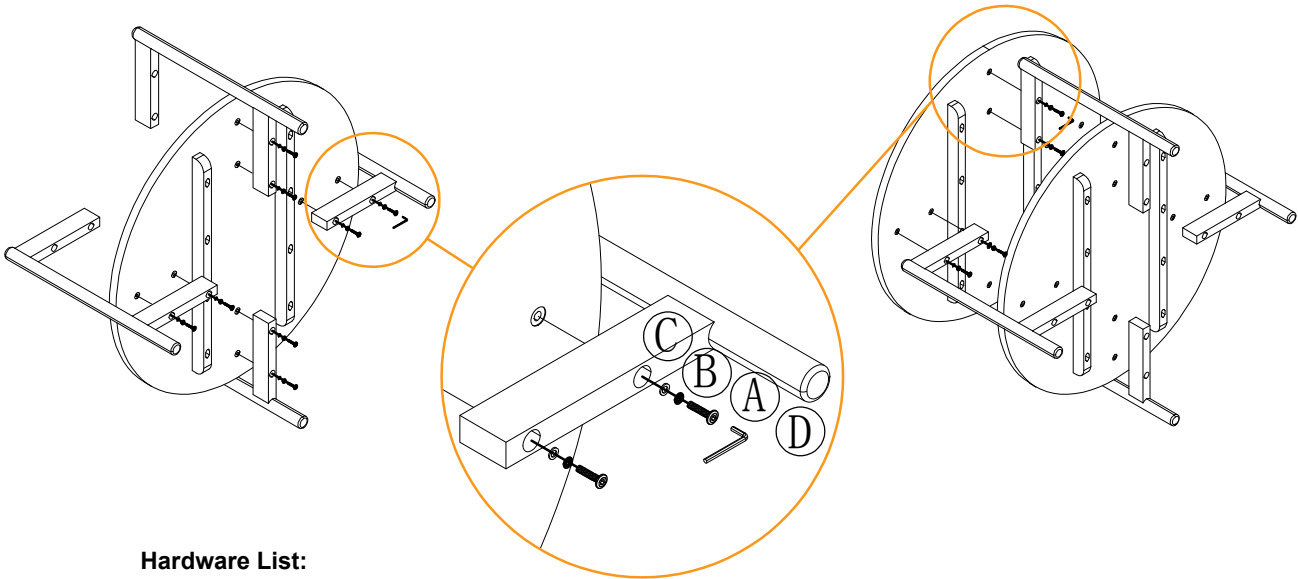

Step 1: Use the Allen wrench (D) to attach the lower shelf to the legs by securing the screws (B) with the flat washers (A) and spring washers (C).

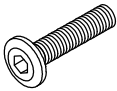
Step 2: Using the same method as in Step 1, attach the top panel to the legs.

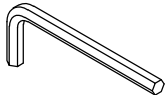

### Hardware List:

 	 	 	 
Screws=16	Spring Washers=16	Flat Washers=16	Allen Wrench=1