

# LINSY 林氏家居

## 五金表/Hardware list

## 部件表/Parts List

### 安装示意图/Assembly Instruction

产品名称 Model NO.

TV2A-A (1.8m)

产品规格 Specification

2138\*1914\*1060mm

安装工具 Tool

安装人数 Installer

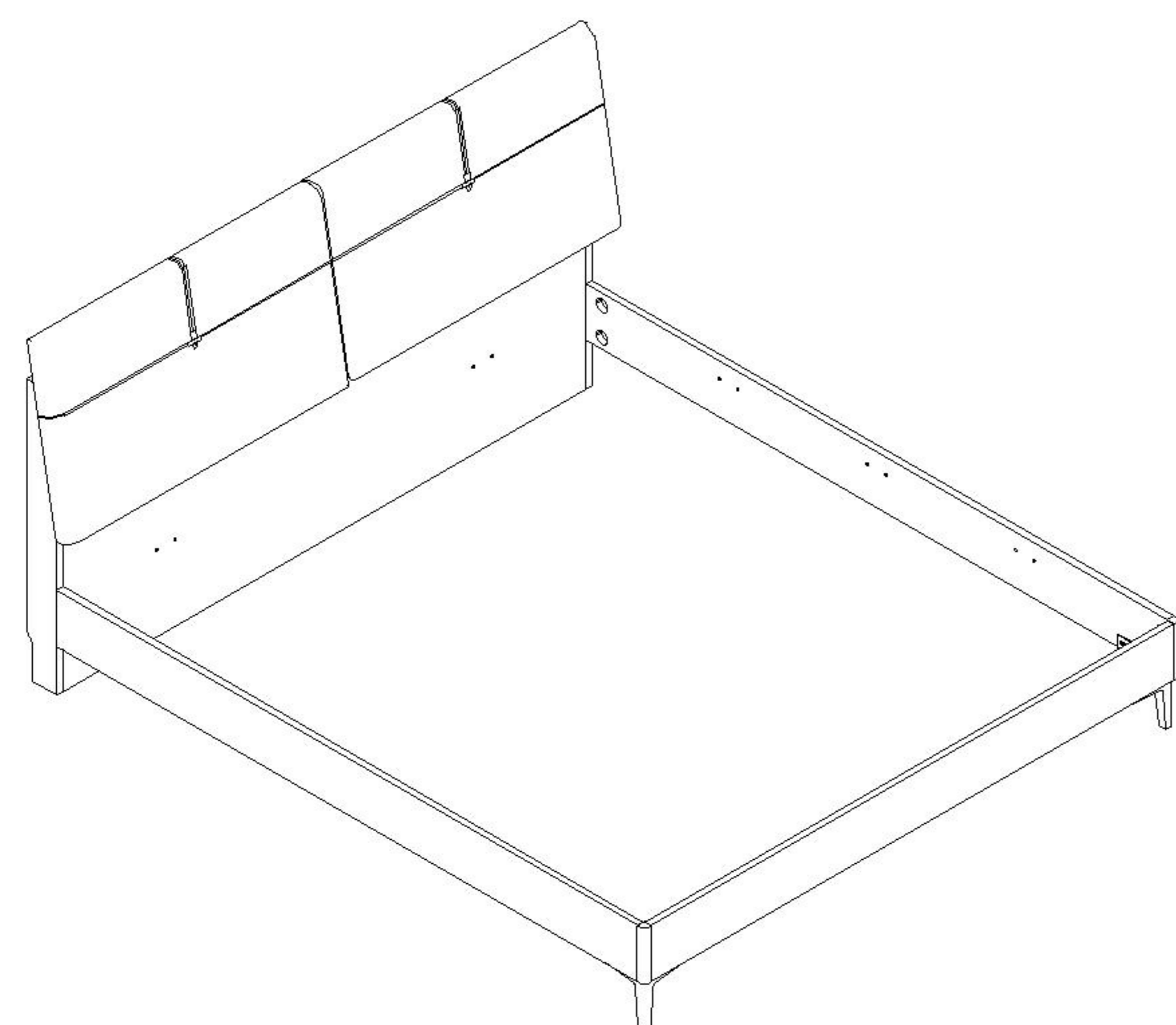
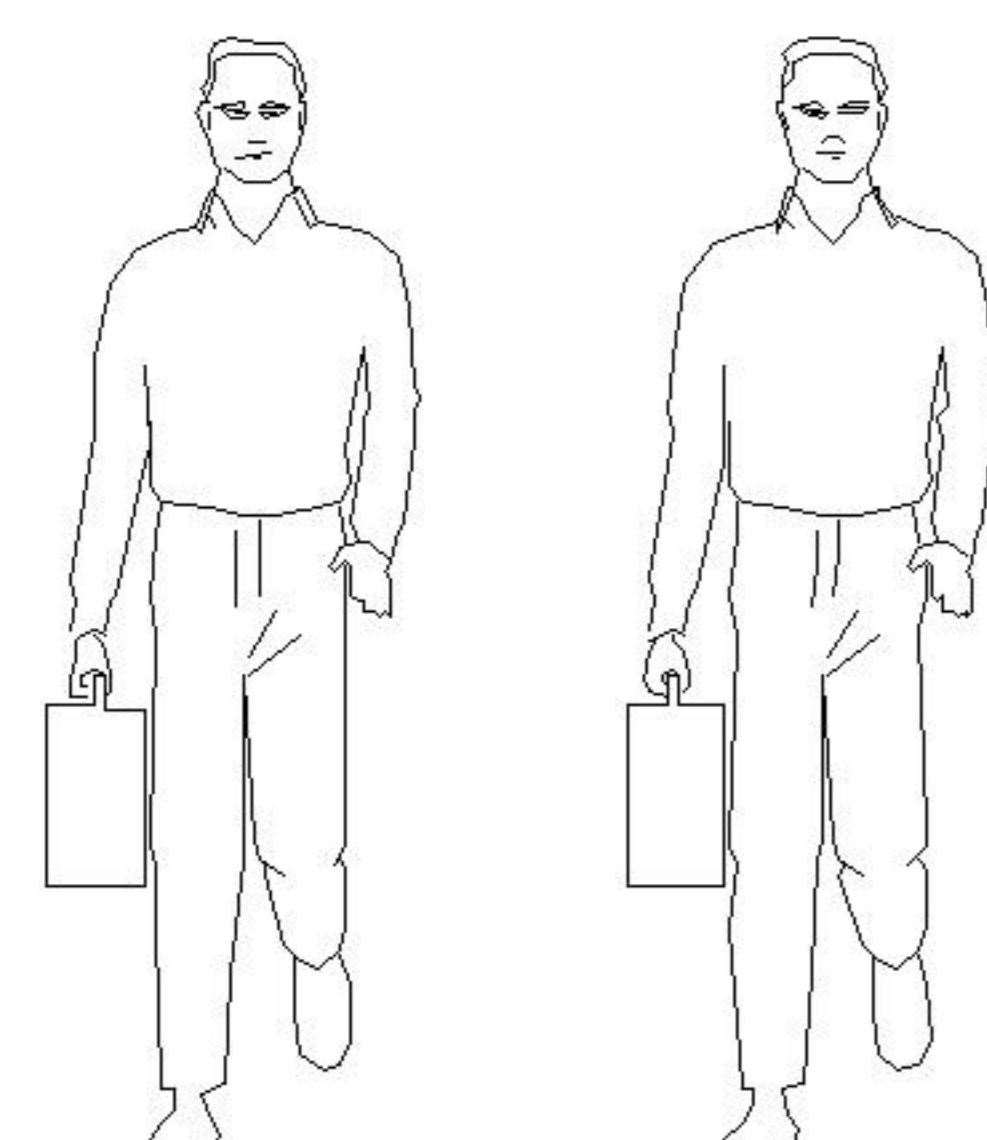
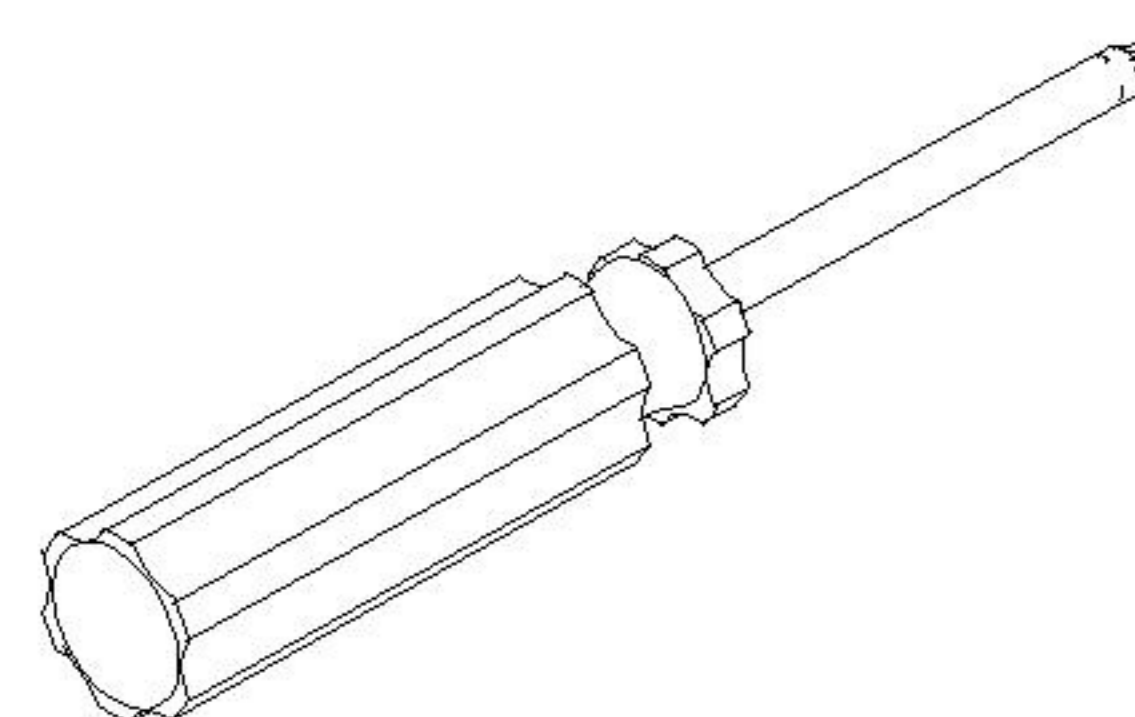

床垫高度建议150-200MM

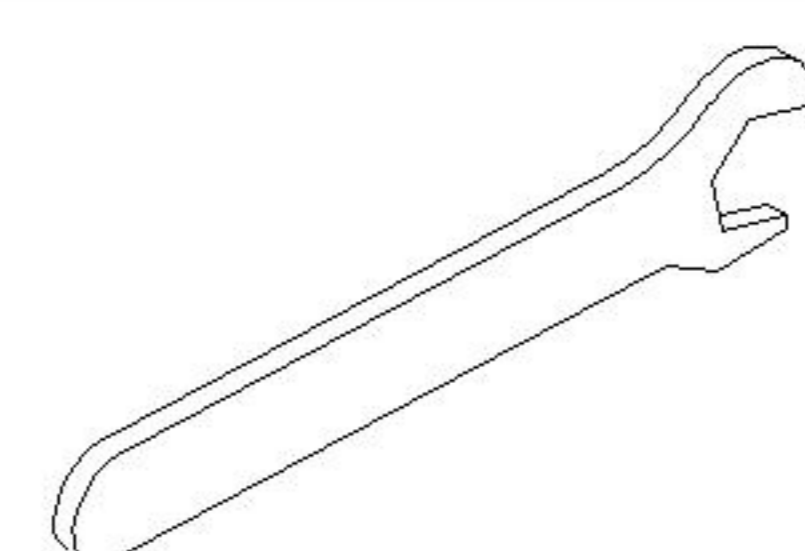

(A)\*1

开口扳手-14mm  
Open Wrench

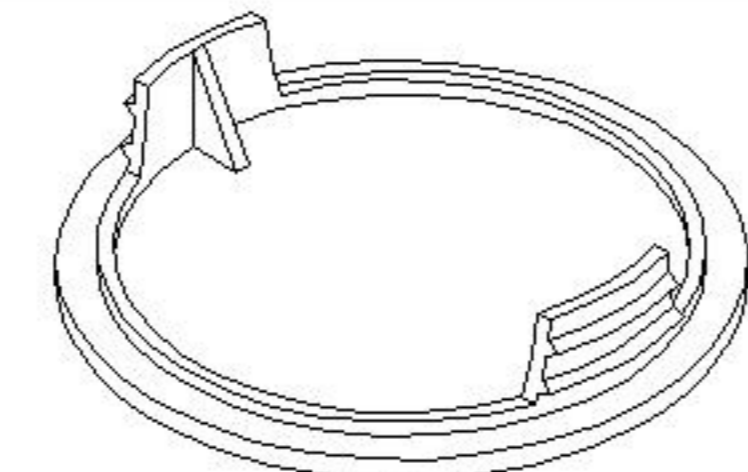

(B)\*4

五合一孔盖  
5-in-1 cover

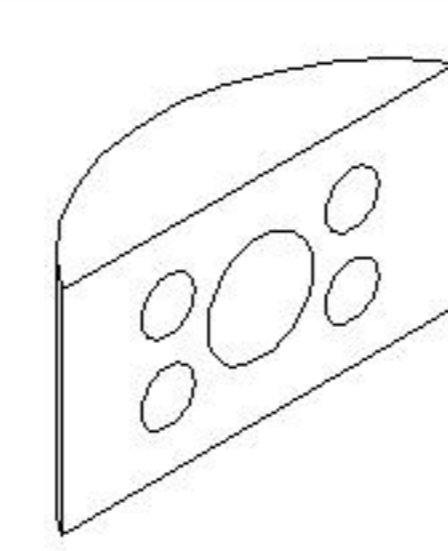

(C)\*4

五合一月牙-M8  
5-in-1 screw

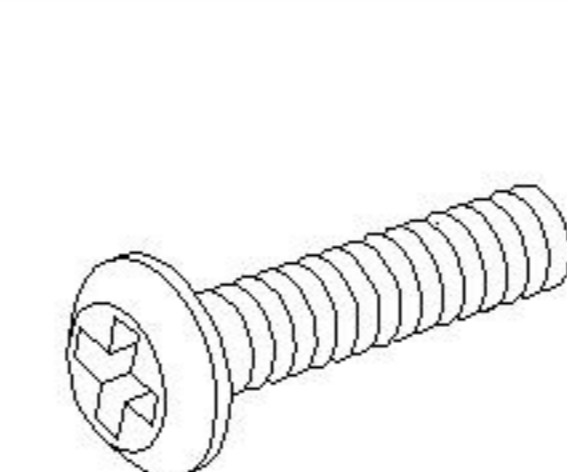

(D)\*12

斜边十字螺杆M8\*15mm  
Bevel cross screw

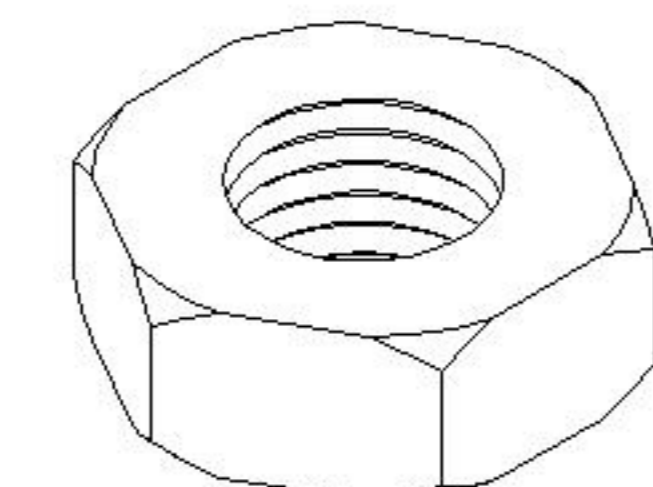

(E)\*8

外六角螺母-M8  
Hexagon Nut

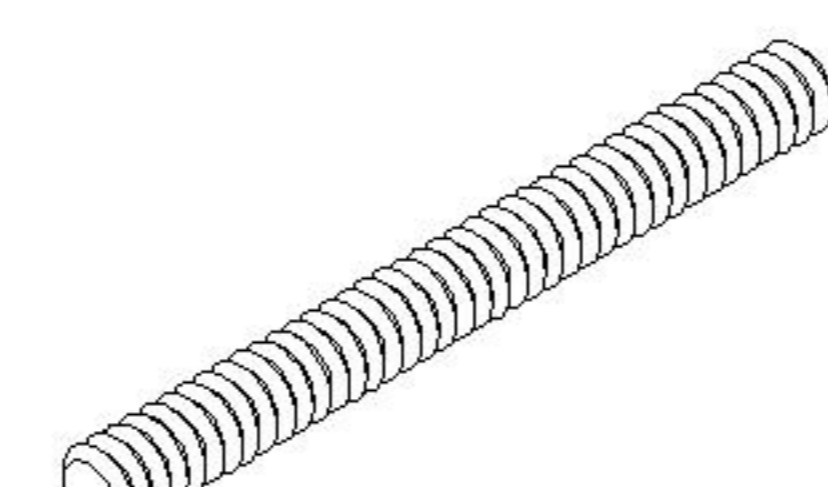

(F)\*4

全牙螺杆-(M8\*100mm)  
Full thread screw

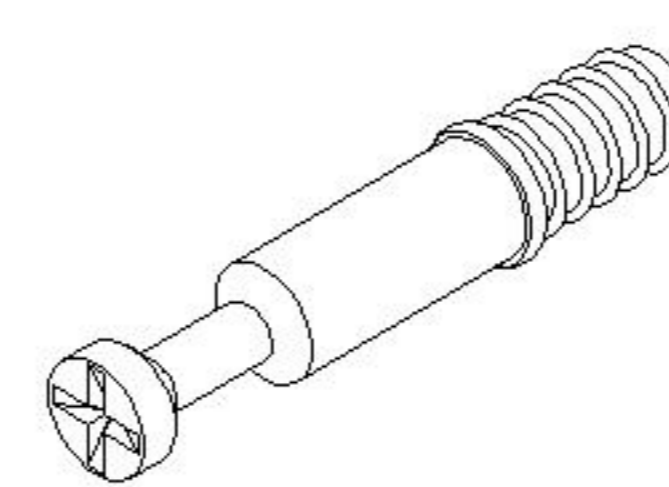

(G)\*15

二合一螺杆  
2-in-1-screw

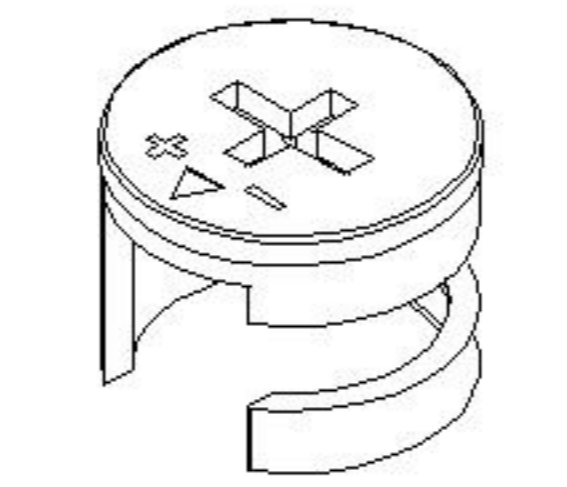

(H)\*23

大三合一锁饼  
Three-in-one large lock

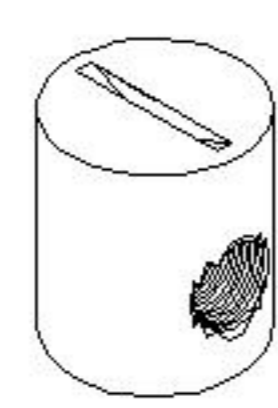

(I)\*4

锤母-(M8\*15mm)  
Product name

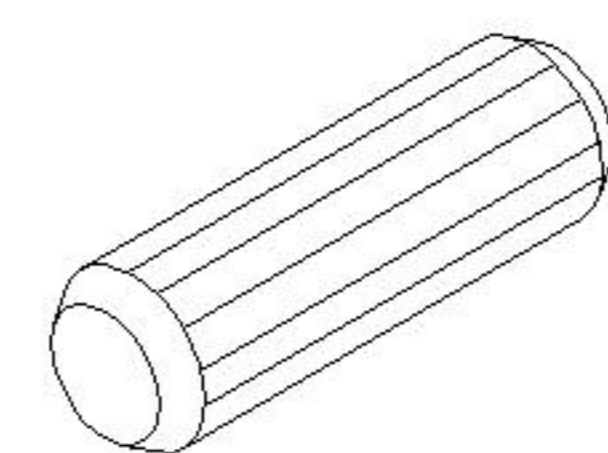

(J)\*4

木榫Ø10x10mm  
Wood tenon

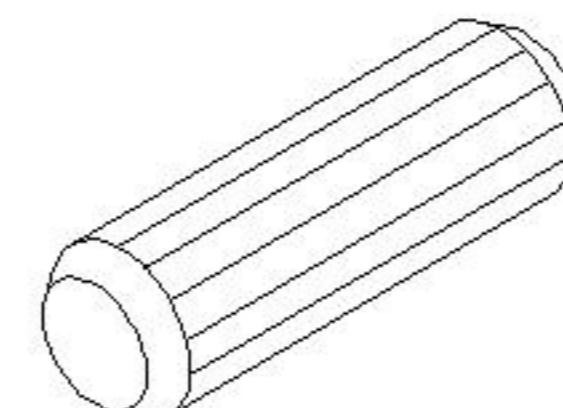

(K)\*8

木榫Ø8x30mm  
Wood tenon

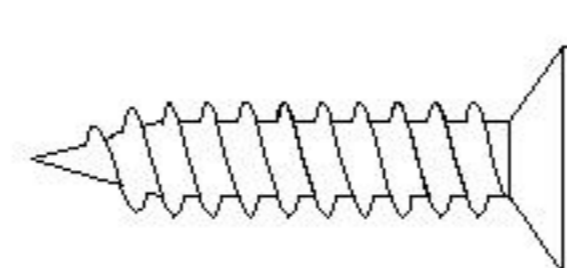

(L)\*27

白攻螺丝M4\*12  
Self-tapping screw



(M)\*13

小角码-(14\*21\*1.5mm)  
Small bracket

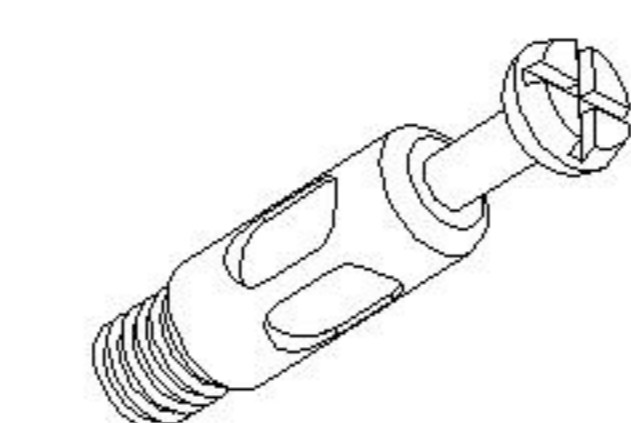

(N)\*8

大三合一螺杆  
3-in-1-screw

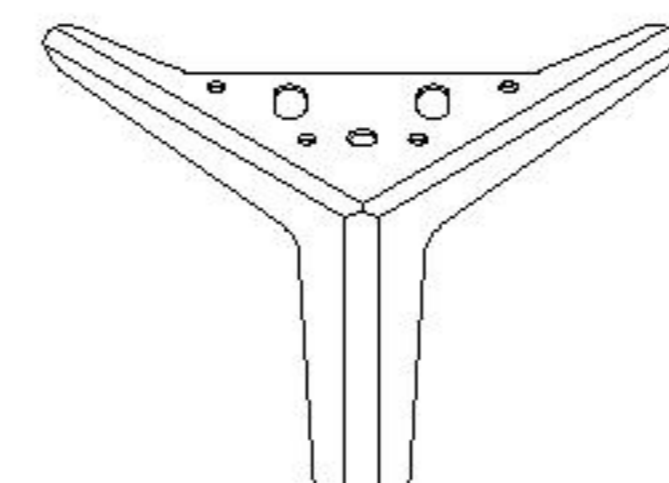

(O)\*2

三叉五金脚  
Trident hardware foot

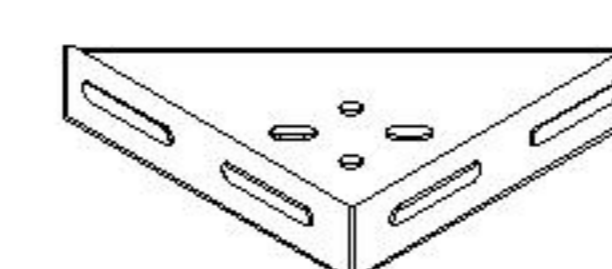

(P)\*2

三角型角码175x175  
Corner code

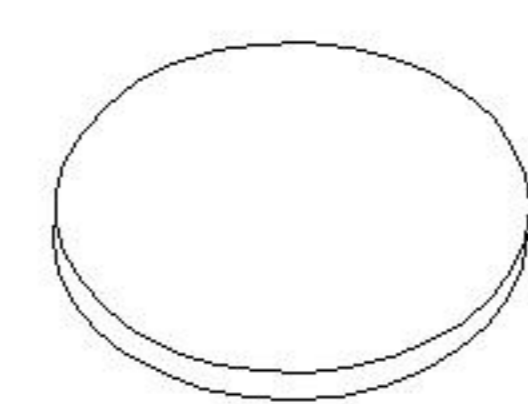

(Q)\*5

灰色毛毡垫  
Grey felt pad

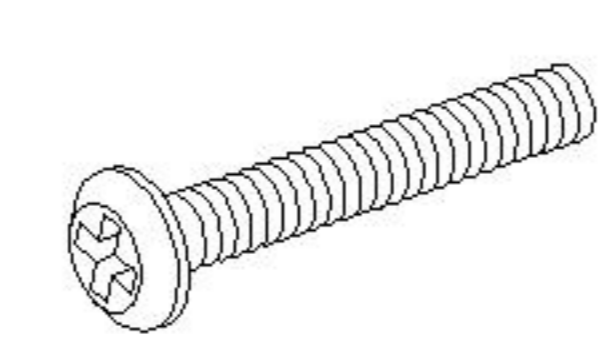

(R)\*20

斜边十字螺杆M6\*45mm  
Bevel cross screw

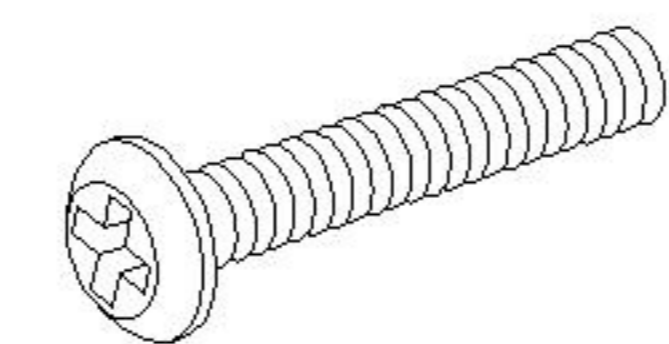

(S)\*2

斜边十字螺杆M8\*40mm  
Bevel cross screw

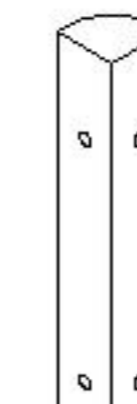

(T)\*2

床角连接件  
Bed corner connector

### 排骨架内带五金

### Row skeleton inside hardware



(U)\*1

板式排骨架1.8米  
Skeleton 1.8 meters

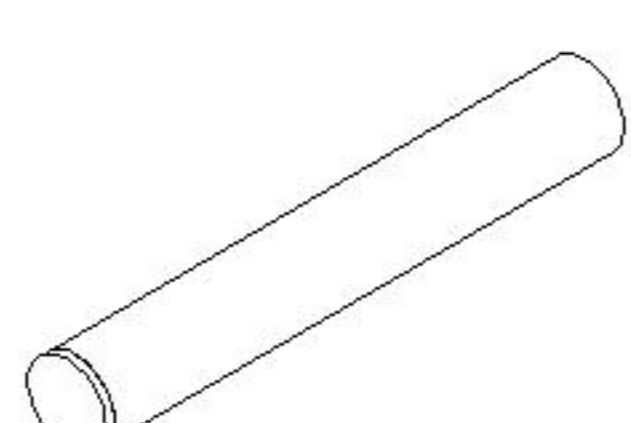

(V)\*2

中脚  
Middle foot

编号NO.

名称Name

规格 (mm)  
Specification

数量QTY

材质Material

①

床头右脚Head bed foot (R)

898\*103\*21

1

三胺板 Melamine

②

床头左脚Head bed foot (L)

898\*103\*21

1

三胺板 Melamine

③

后背中支撑条  
Middle back support strip

895\*87\*21

1

三胺板 Melamine

④

床头顶条Top bar of bed head

1810\*78\*15

1

三胺板 Melamine

⑤

床头主板Bed headboard

1810\*298\*15

1

三胺板 Melamine

⑥

床头下节主板  
Board under head bed

1810\*500\*15

1

三胺板 Melamine

⑦

床尾Bed tail

1806\*168\*21

1

三胺板 Melamine

⑧

右床侧Bedside (R)

2010\*168\*21

1

三胺板 Melamine

⑨

左床侧Bedside (L)

2010\*168\*21

1

三胺板 Melamine

⑩

床头软包  
Upholstered headboard

2

软包Upholstered

TV2A-A (1.8m)

安装方法  
Installation method

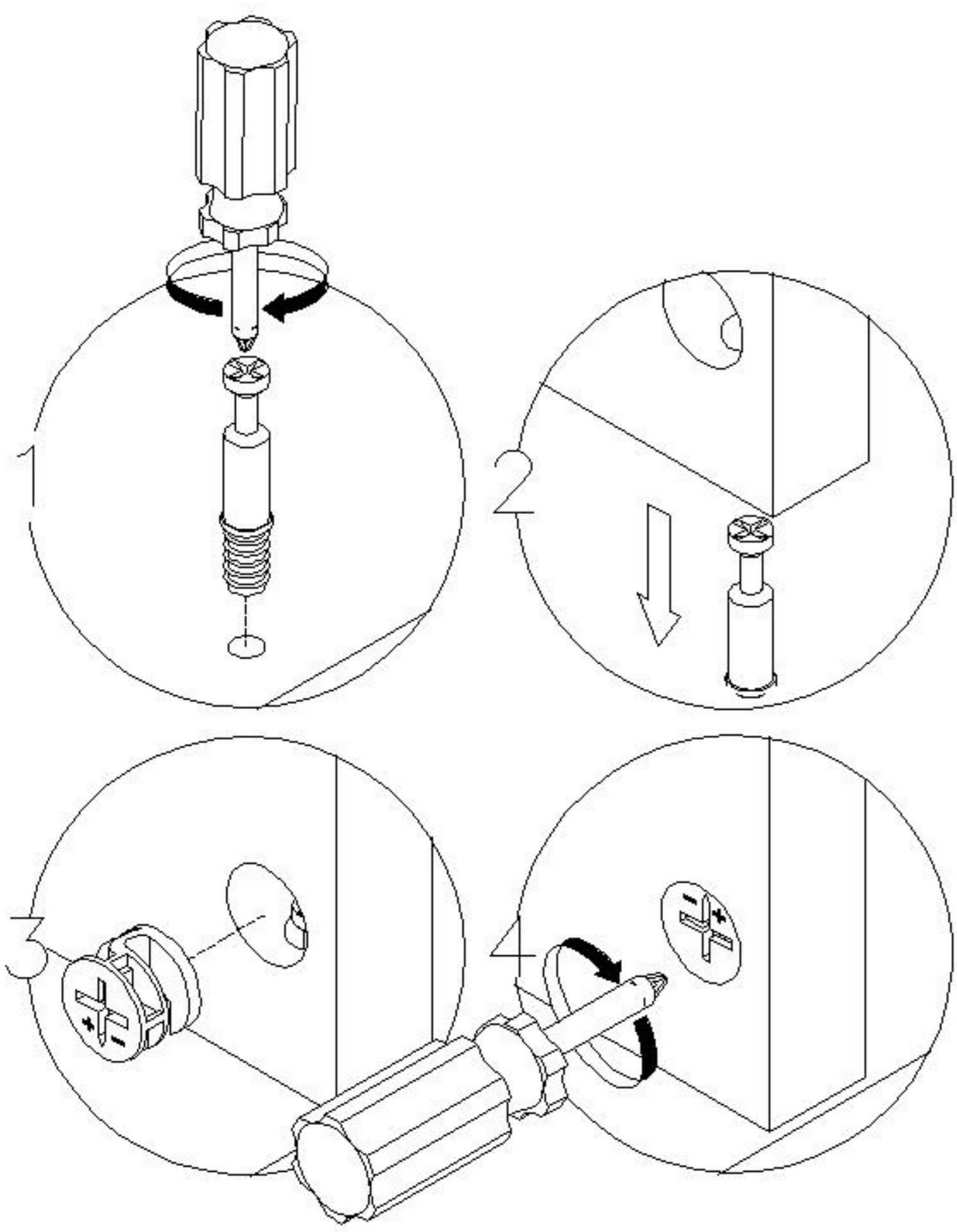

二合一 two-in-one

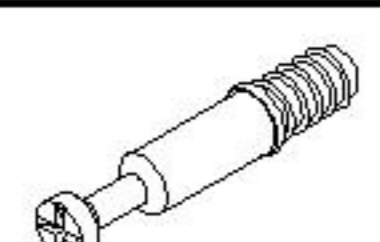
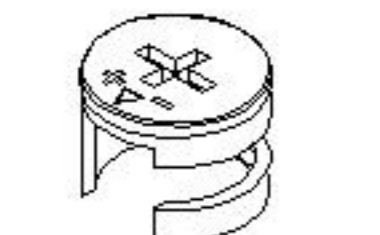
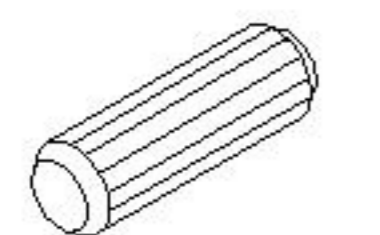
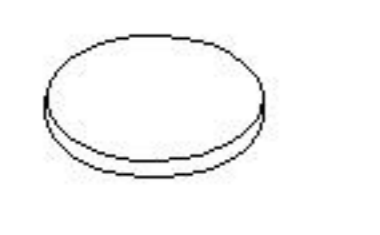
-  (G)\*12
-  (H)\*12
-  (K)\*8
-  (Q)\*4

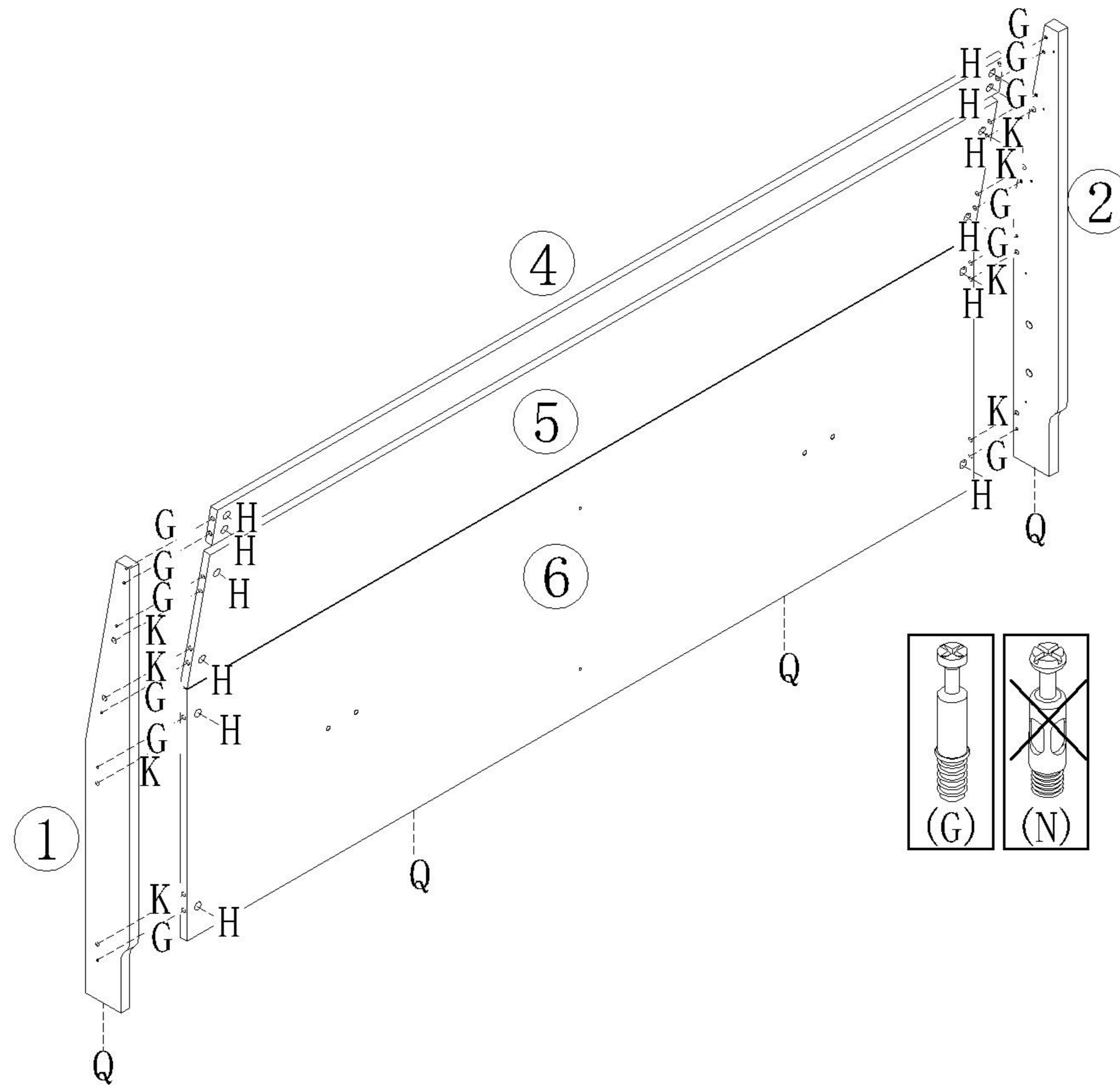

1

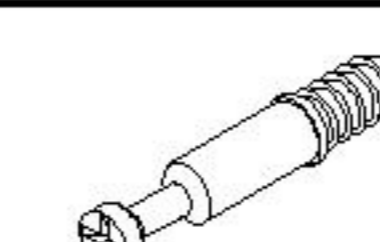
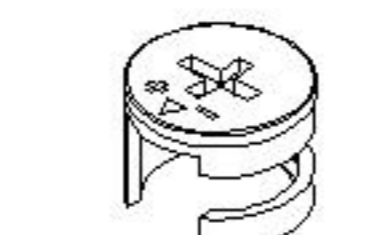
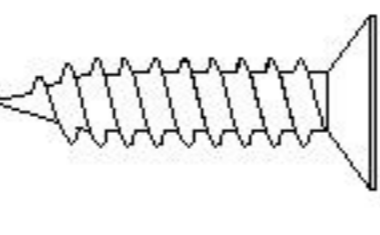
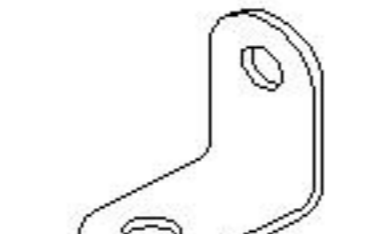
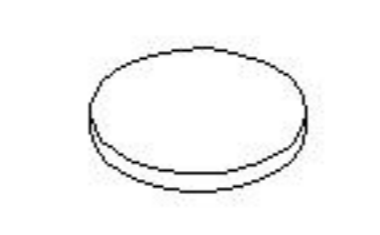
-  (G)\*2
-  (H)\*2
-  (L)\*26
-  (M)\*13
-  (Q)\*1

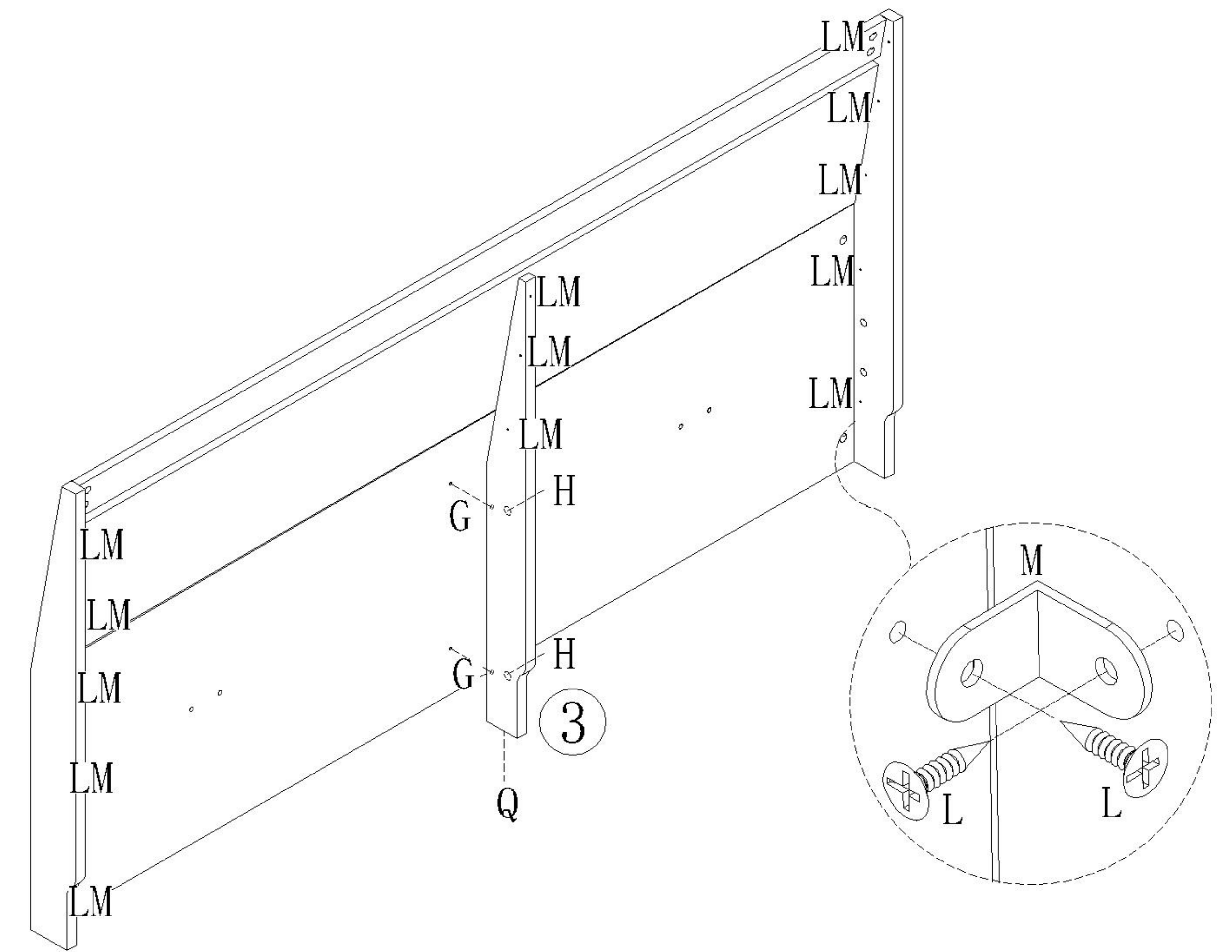

2

3

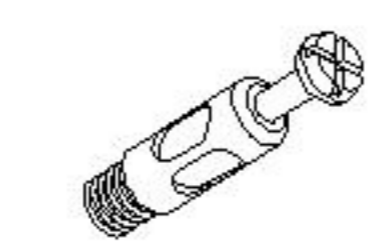
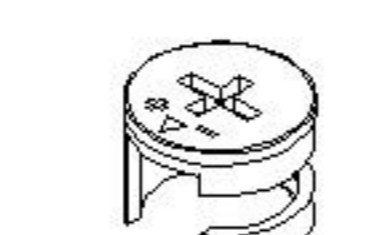
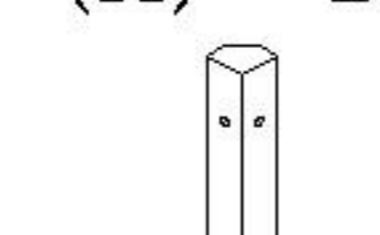
-  (N)\*4
-  (H)\*4
-  (T)\*2

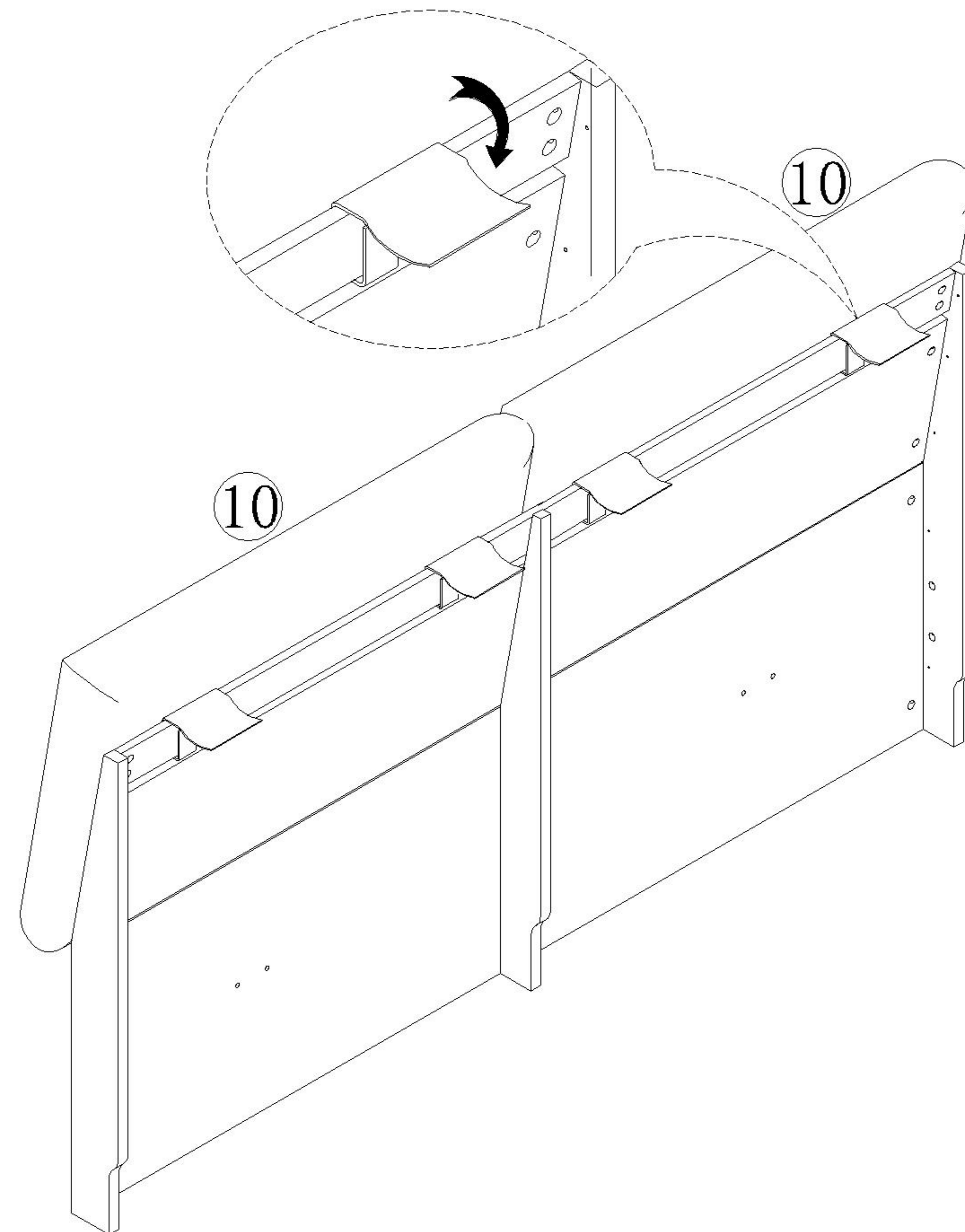

4

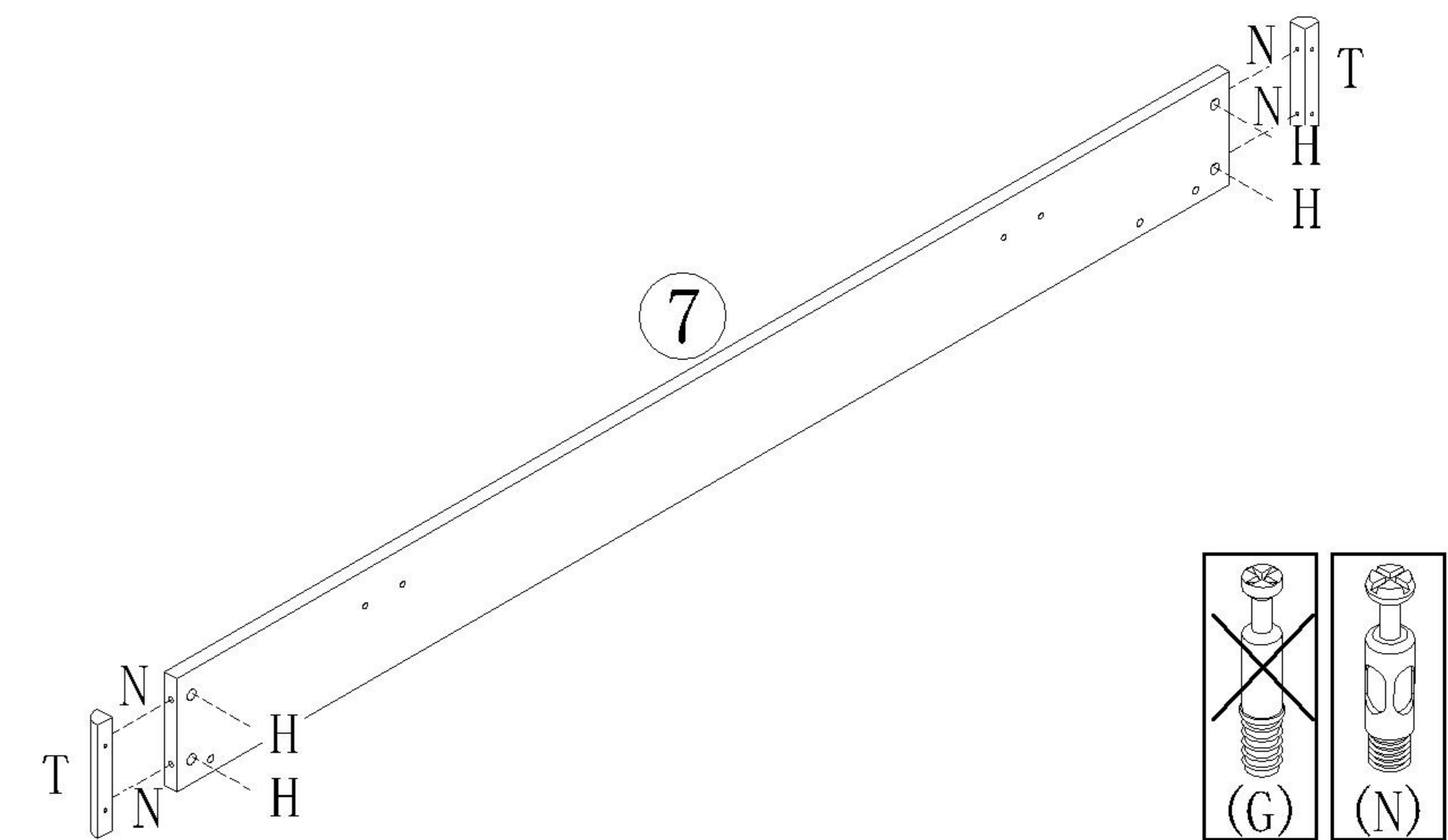

TV2A-A (1.8m)

安装方法  
Installation method

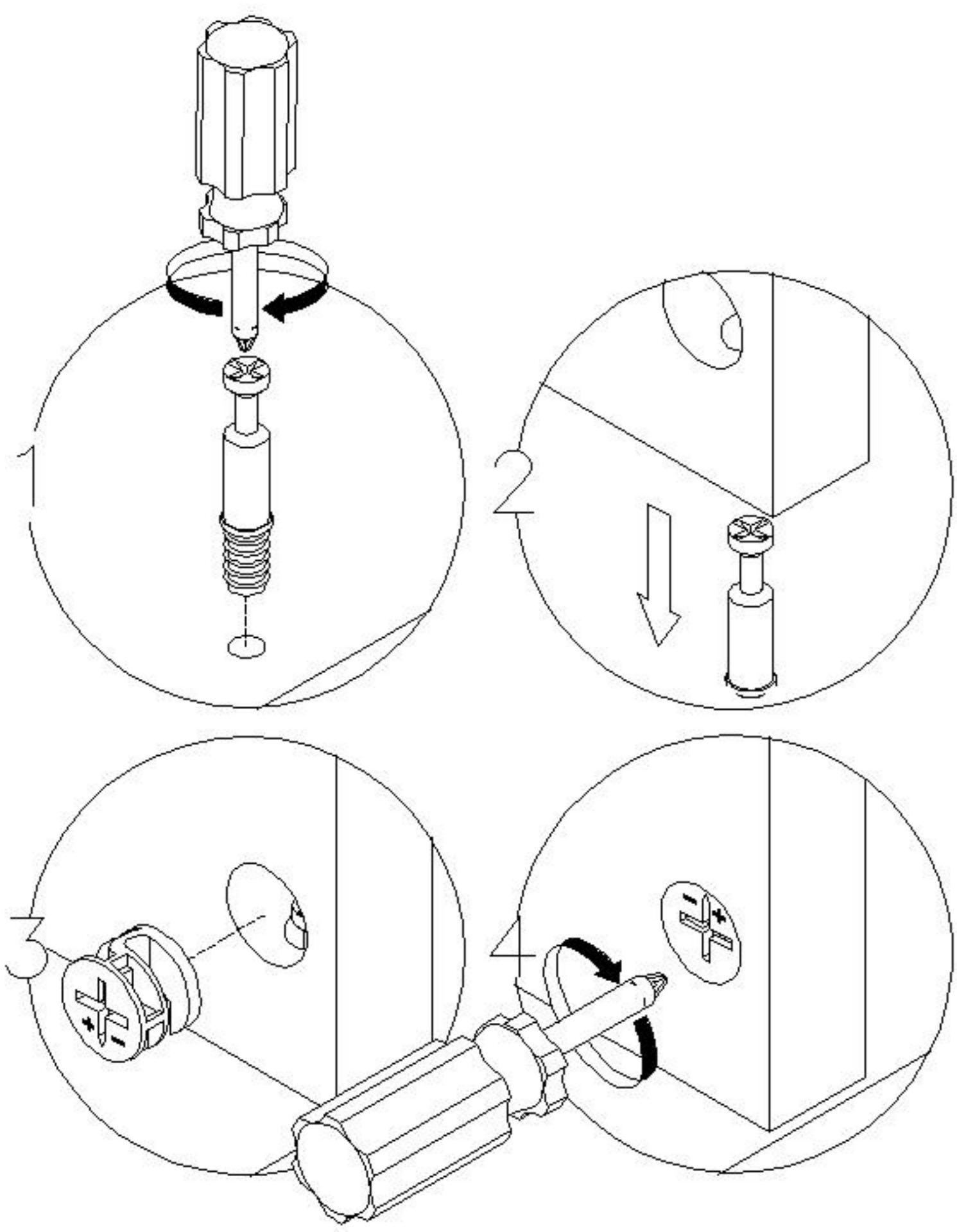

二合一 two-in-one

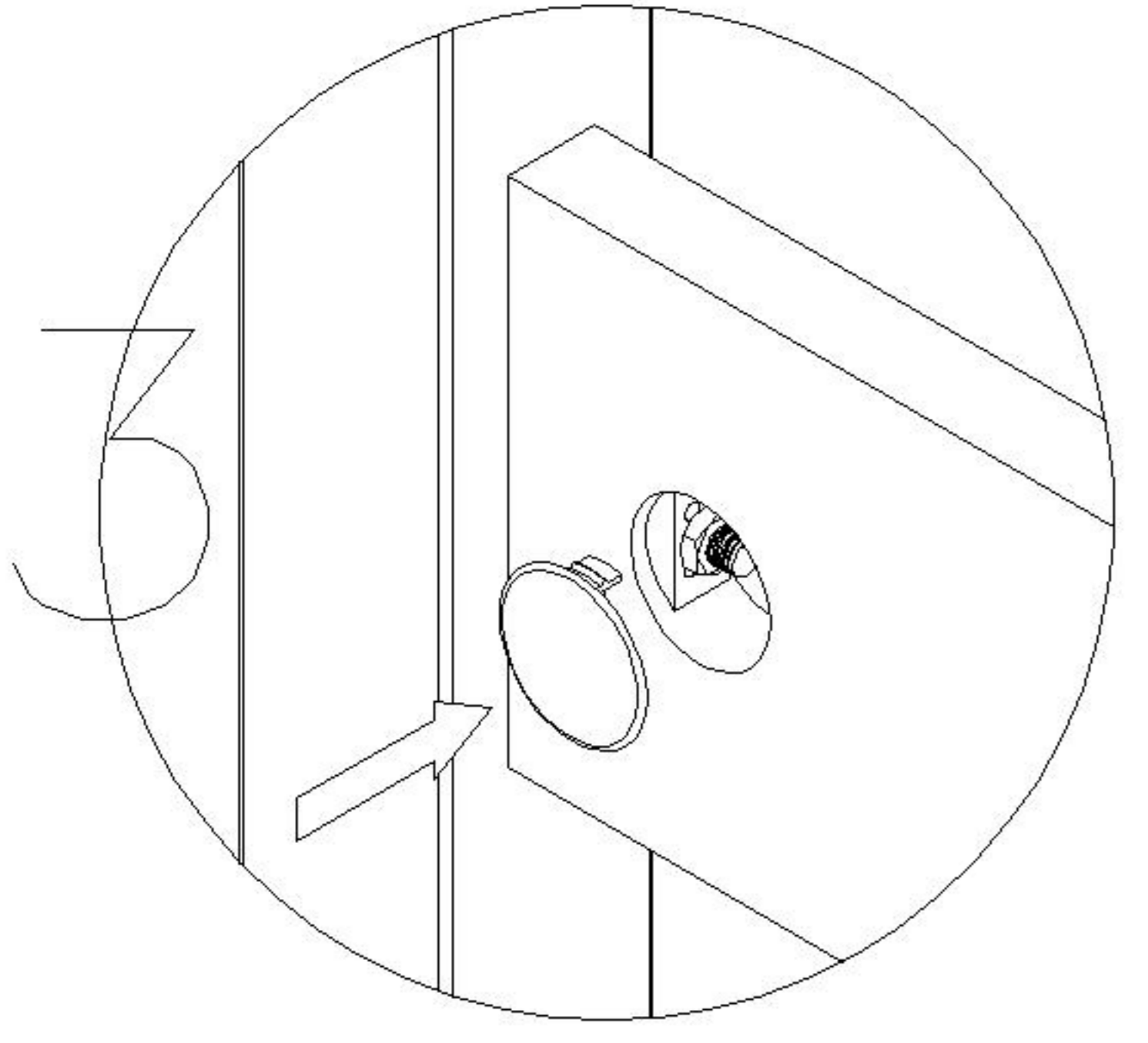
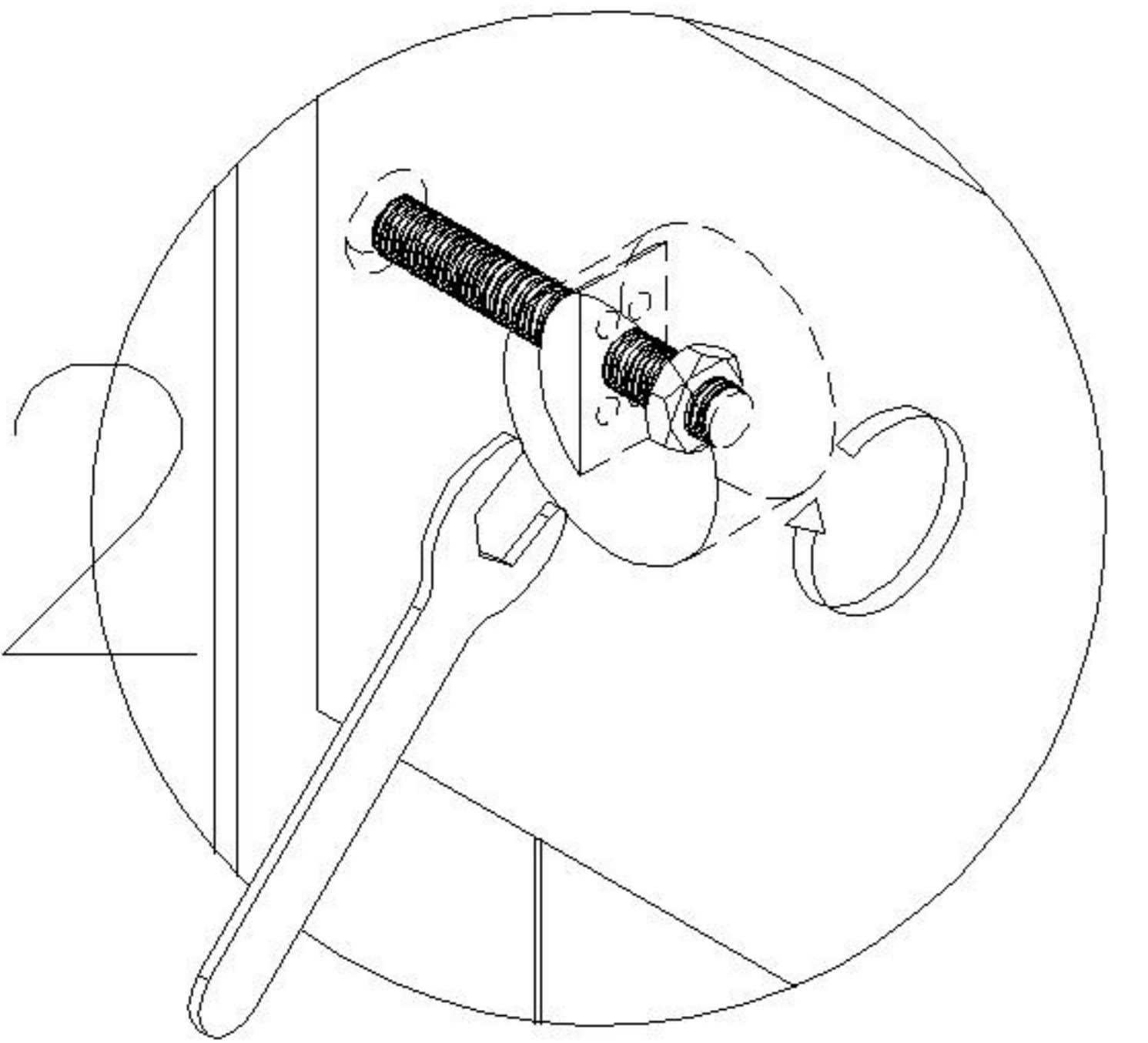
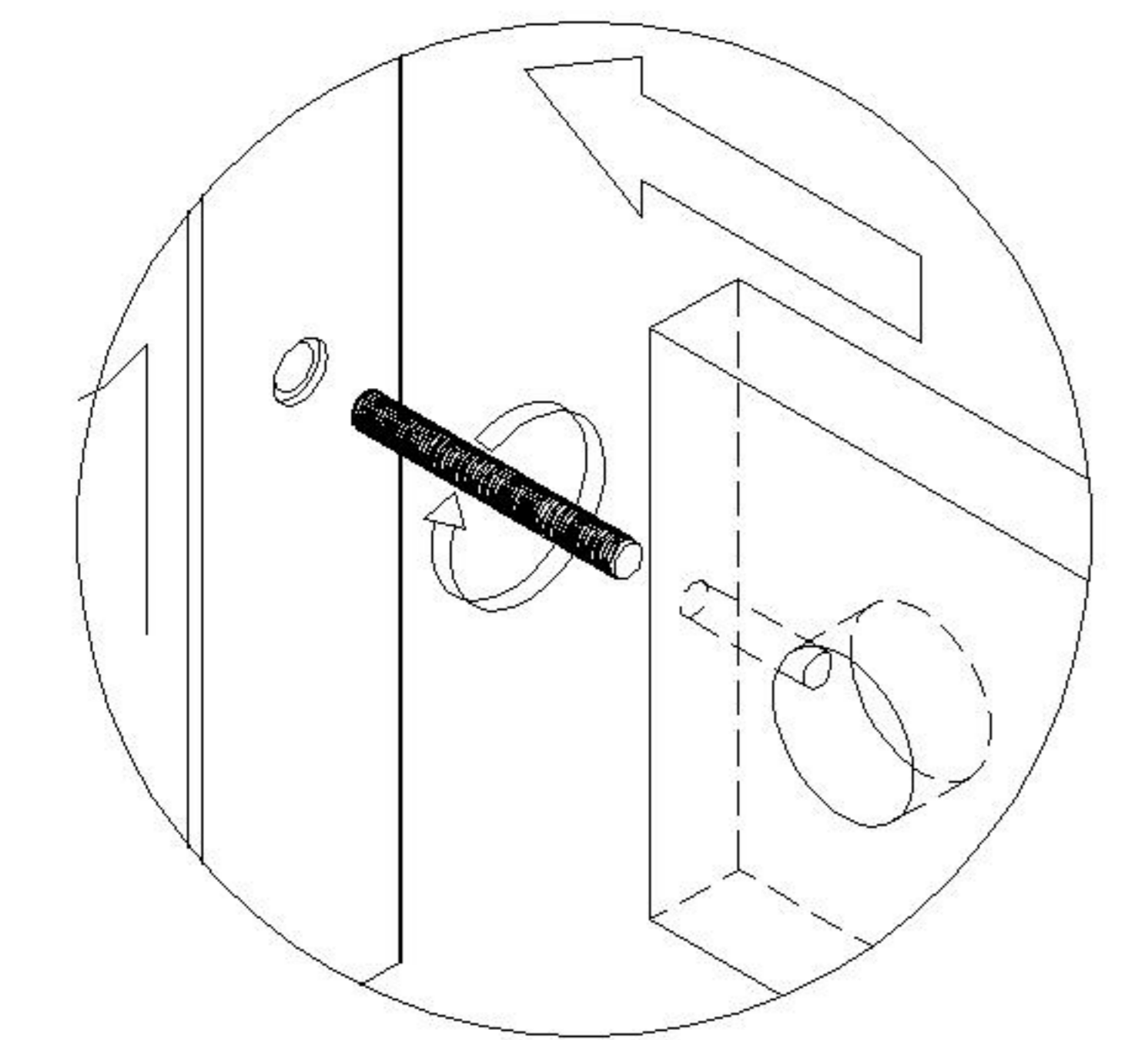

五合一  
5-in-1

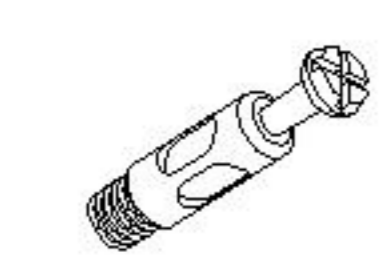

(N)\*4

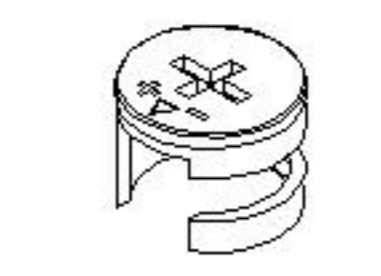

(H)\*4

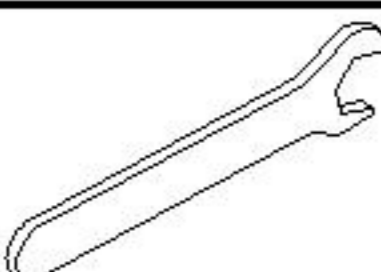

(A)\*1

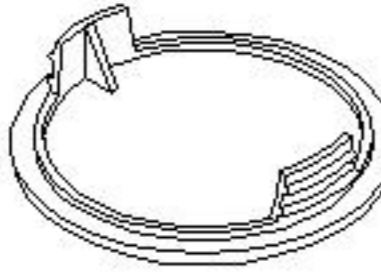

(B)\*4

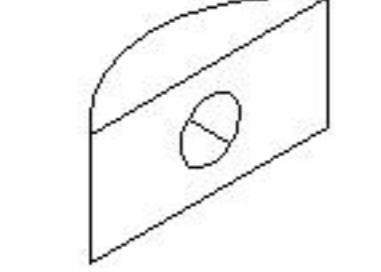

(C)\*4



(E)\*4

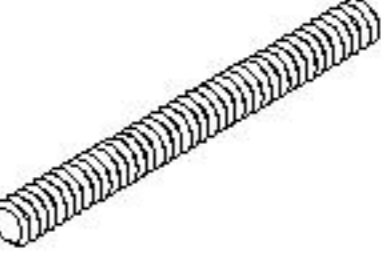

(F)\*4

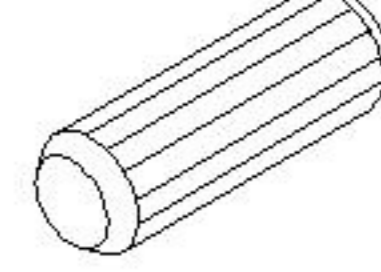

(J)\*4



(I)\*4

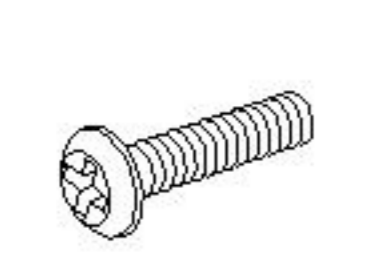

(D)\*8

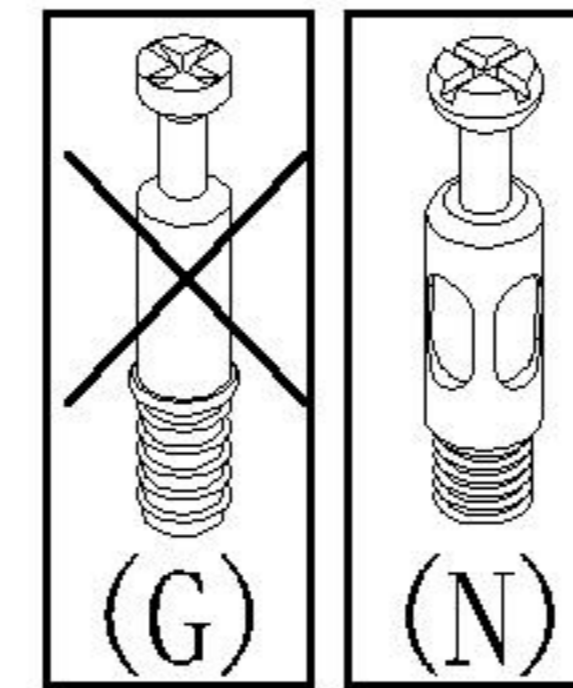
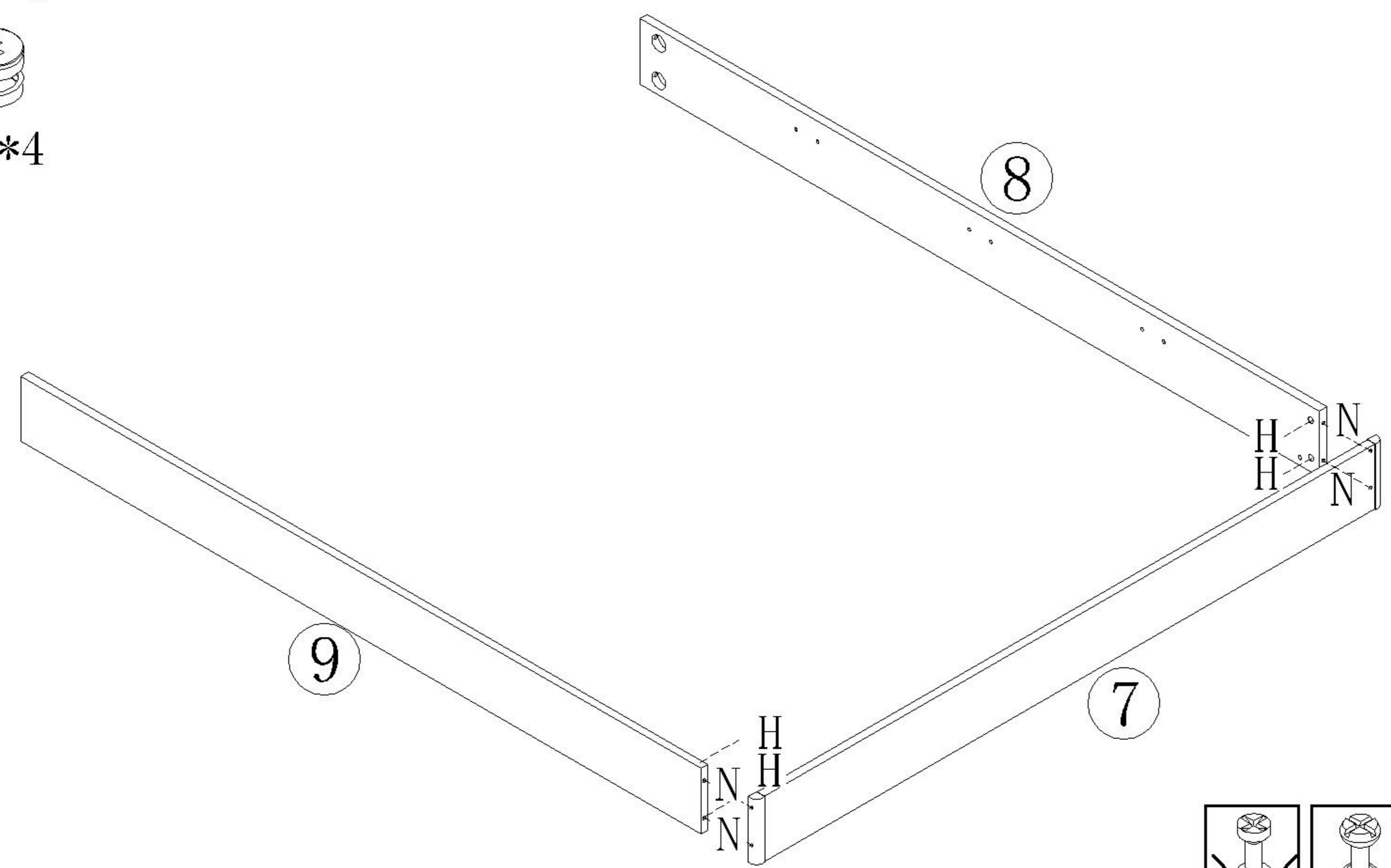

5



(E)\*4

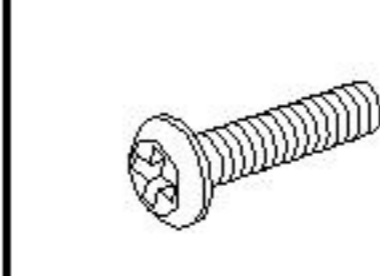

(D)\*4

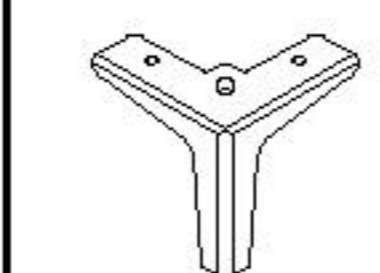

(O)\*2

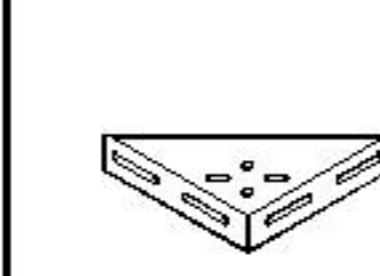

(P)\*2

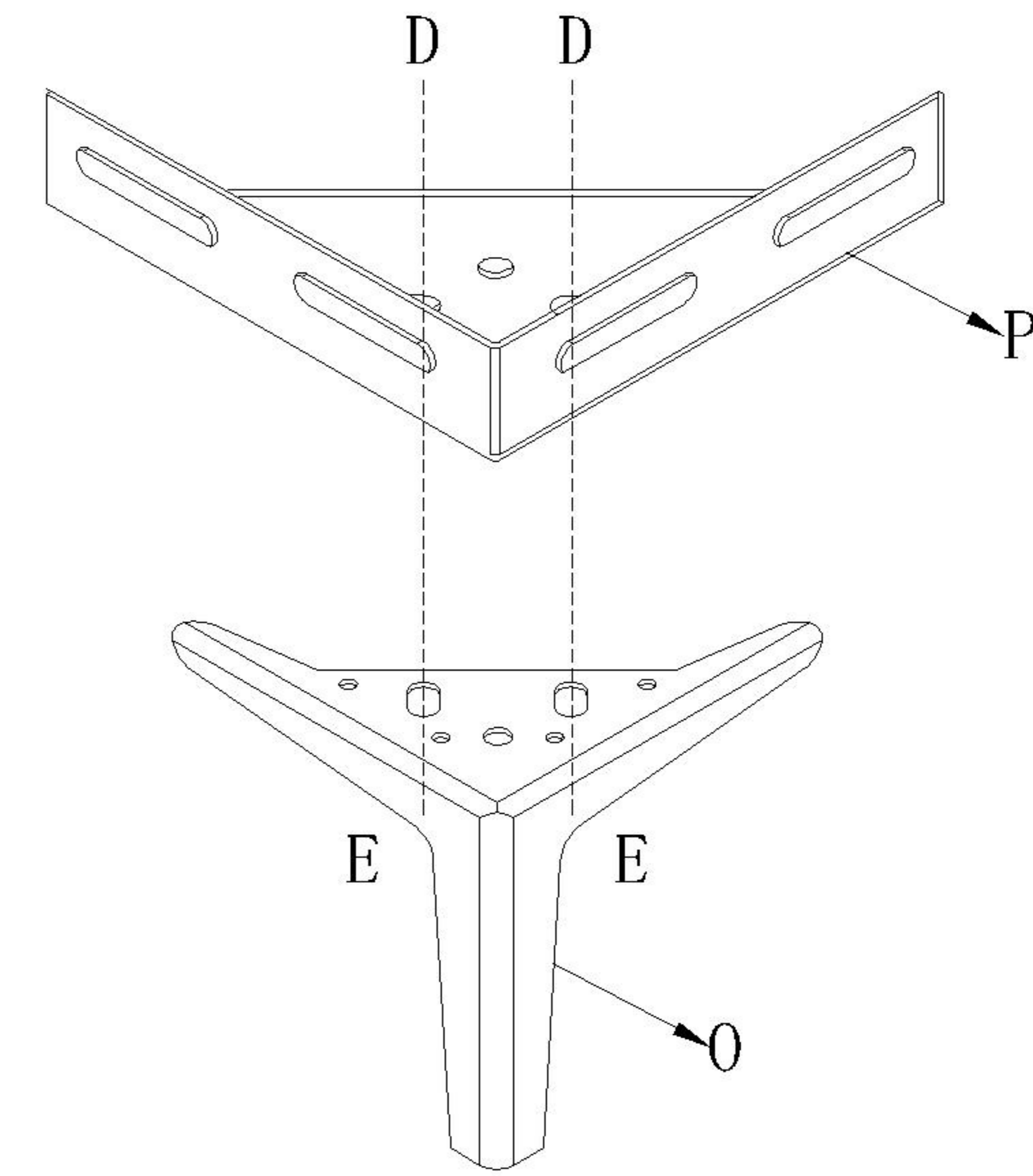

x2

6

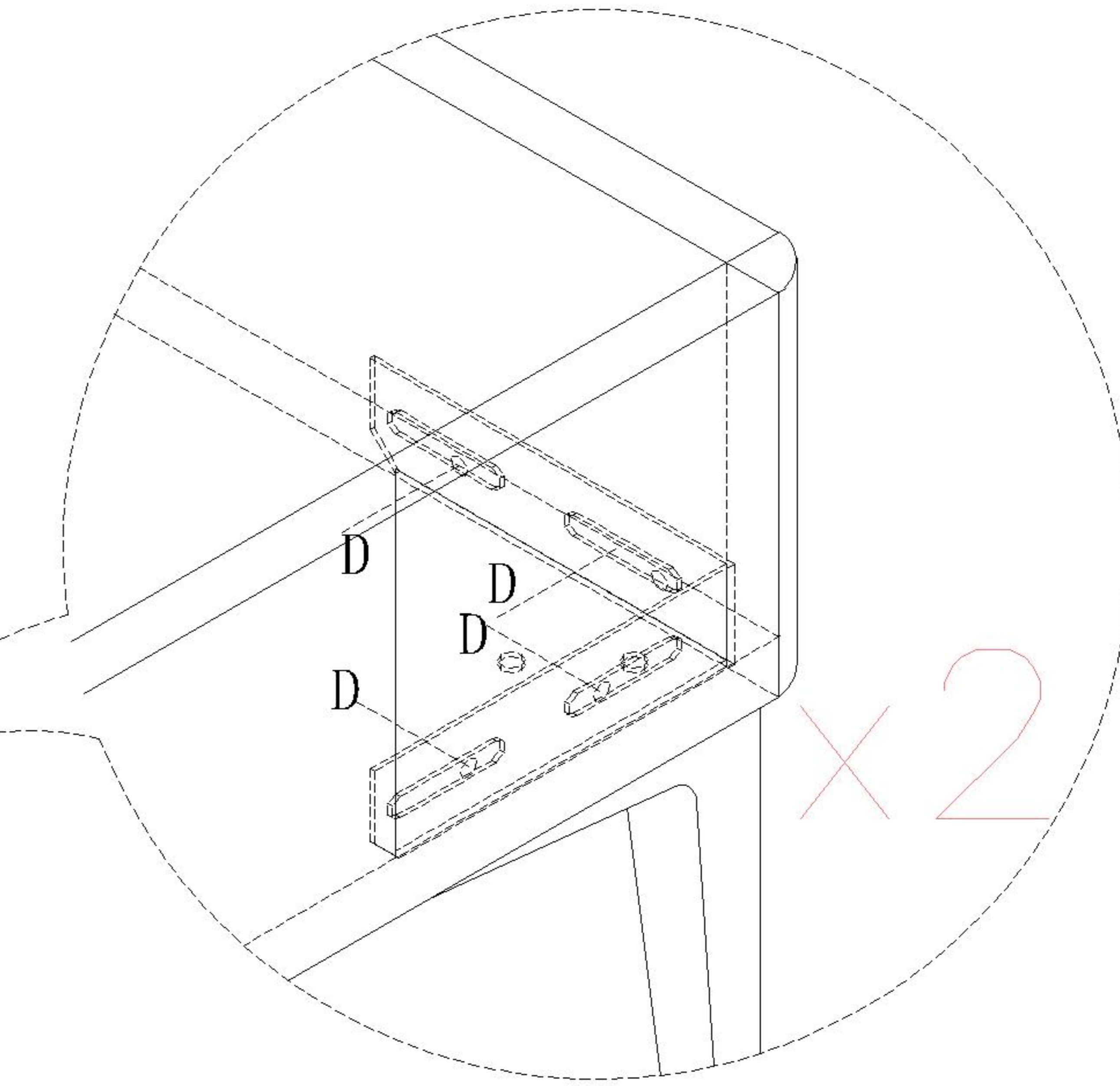
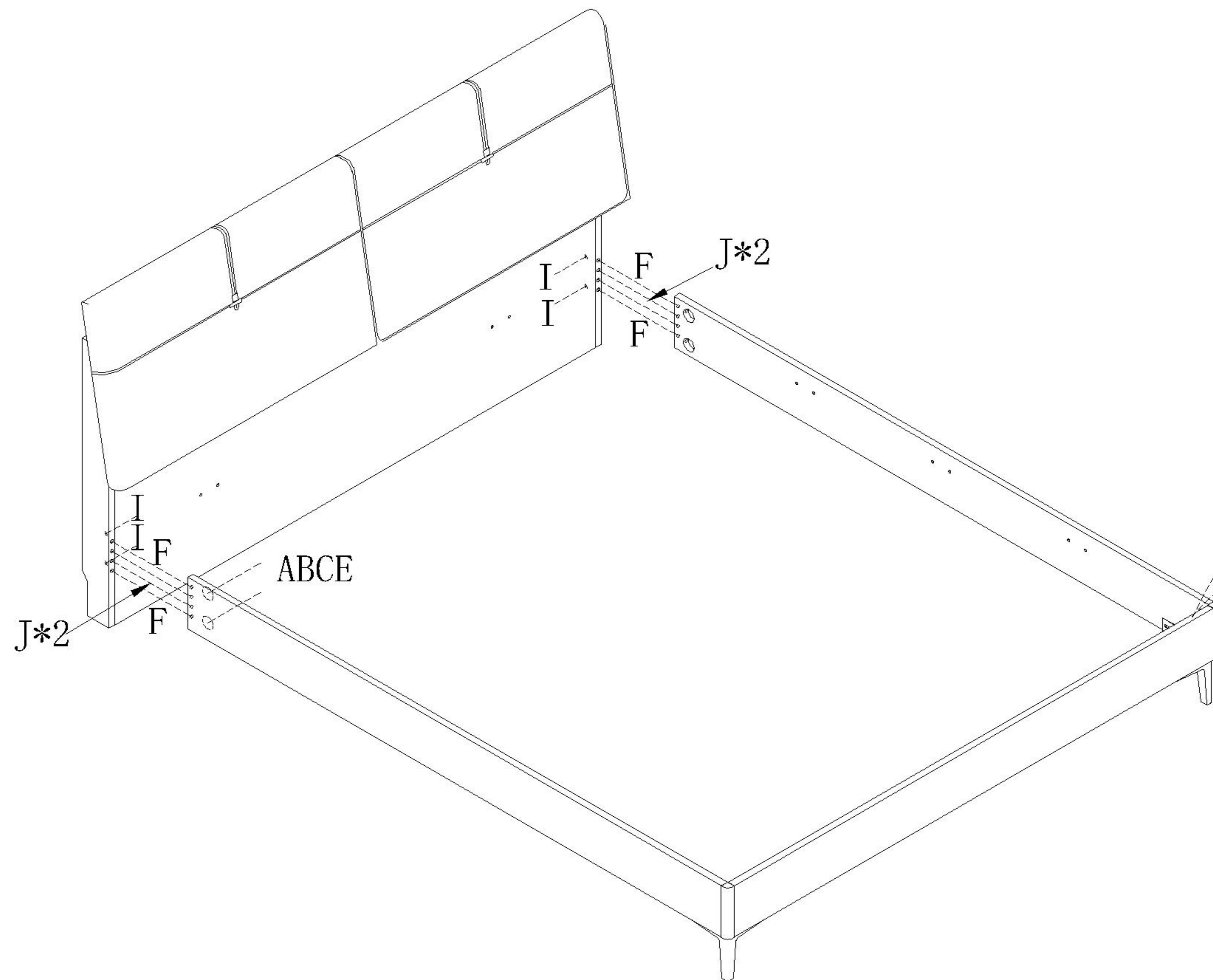

x2

7

TV2A-A (1.8m)

安装方法  
Installation method

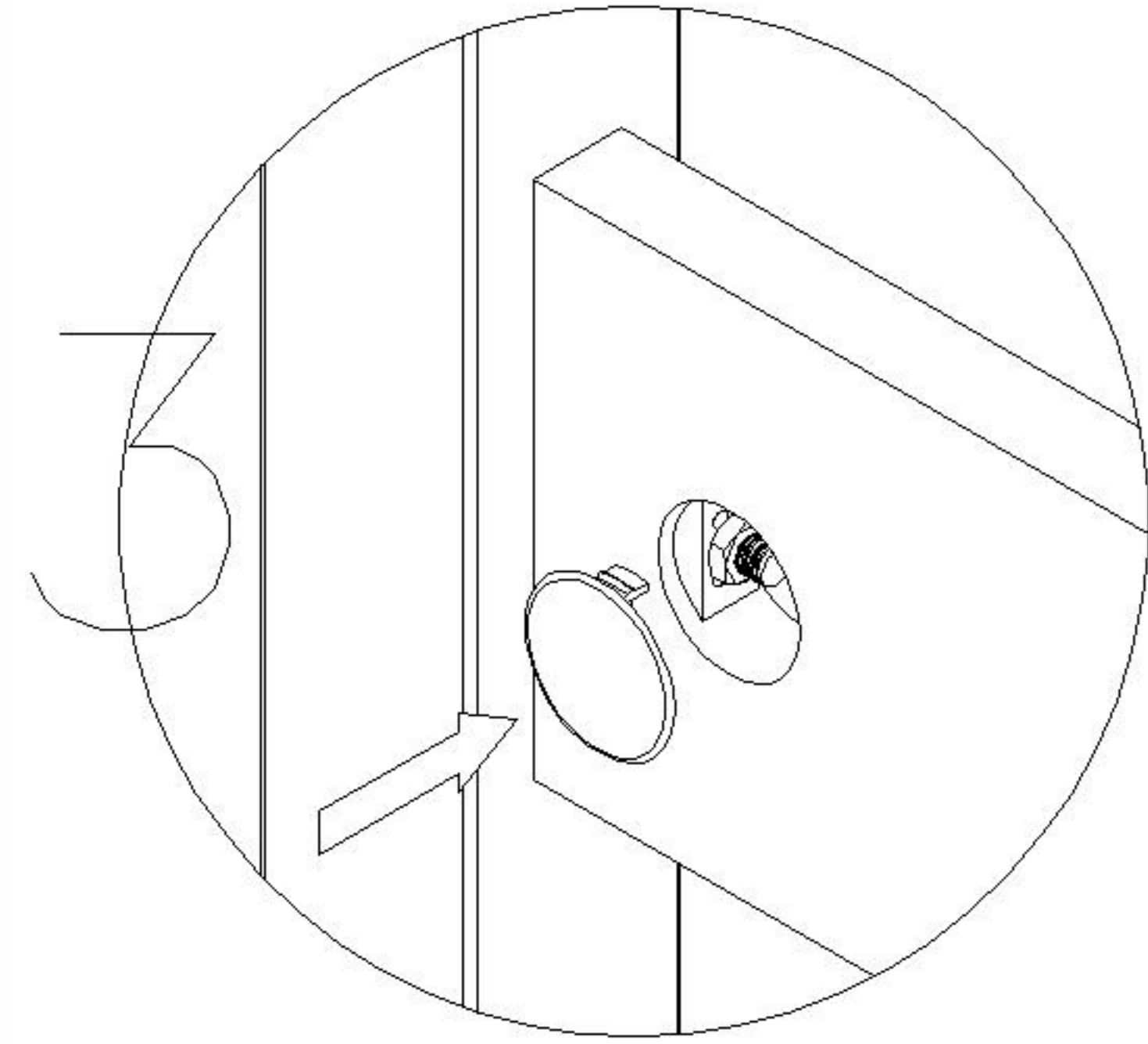
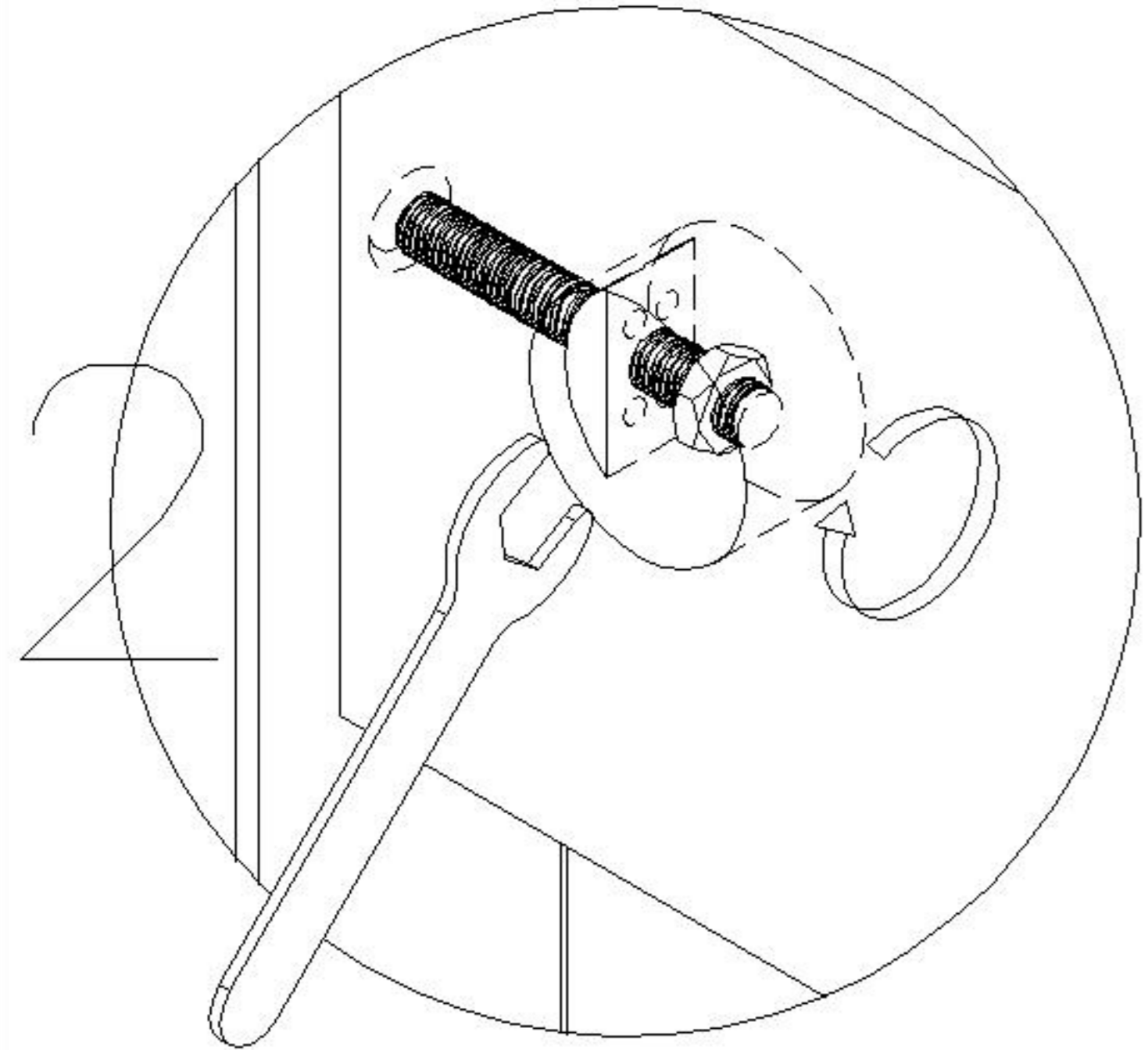
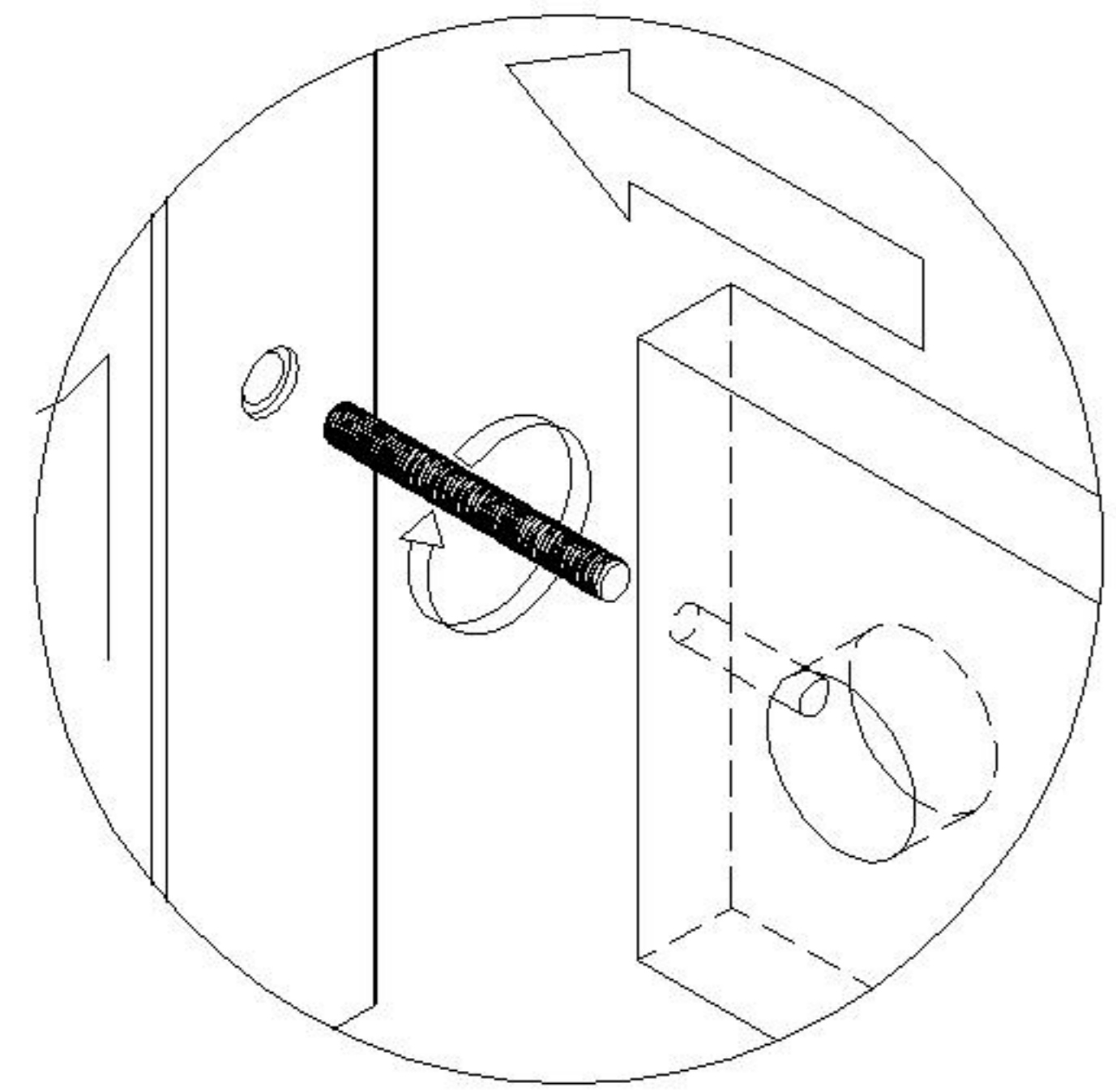

五合一  
5-in-1

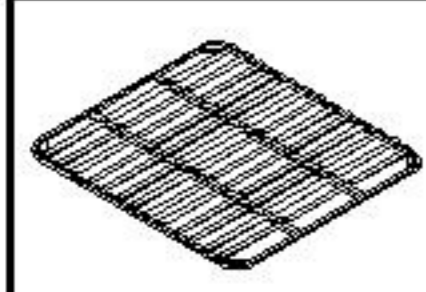

(U)\*1

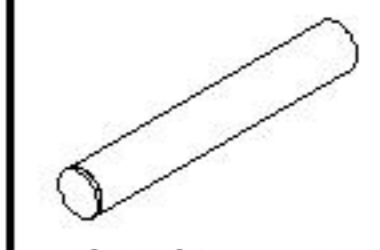

(V)\*2

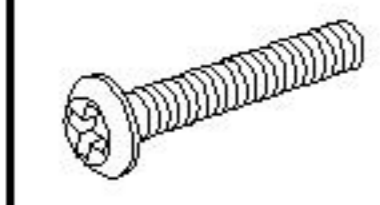

(S)\*2

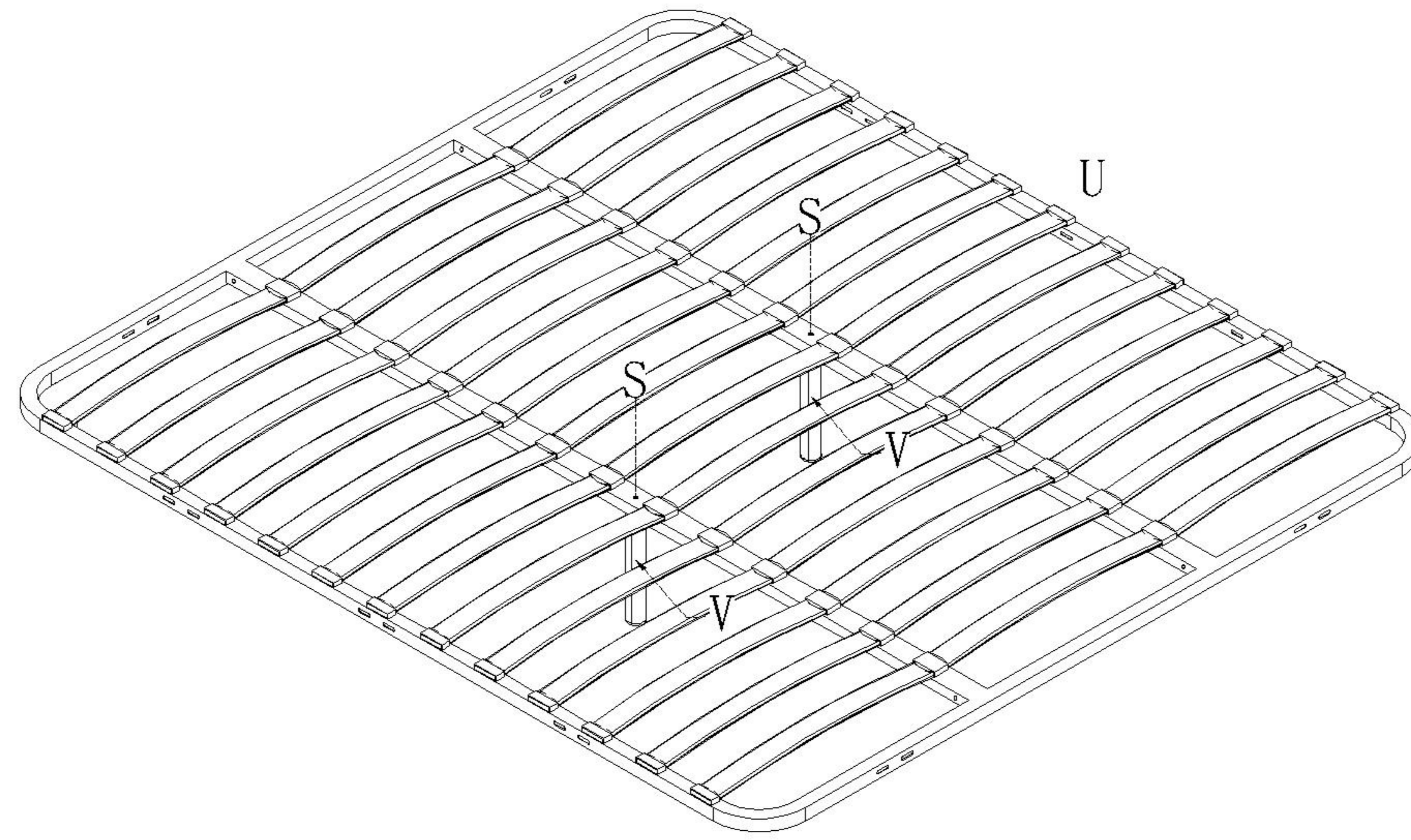

8

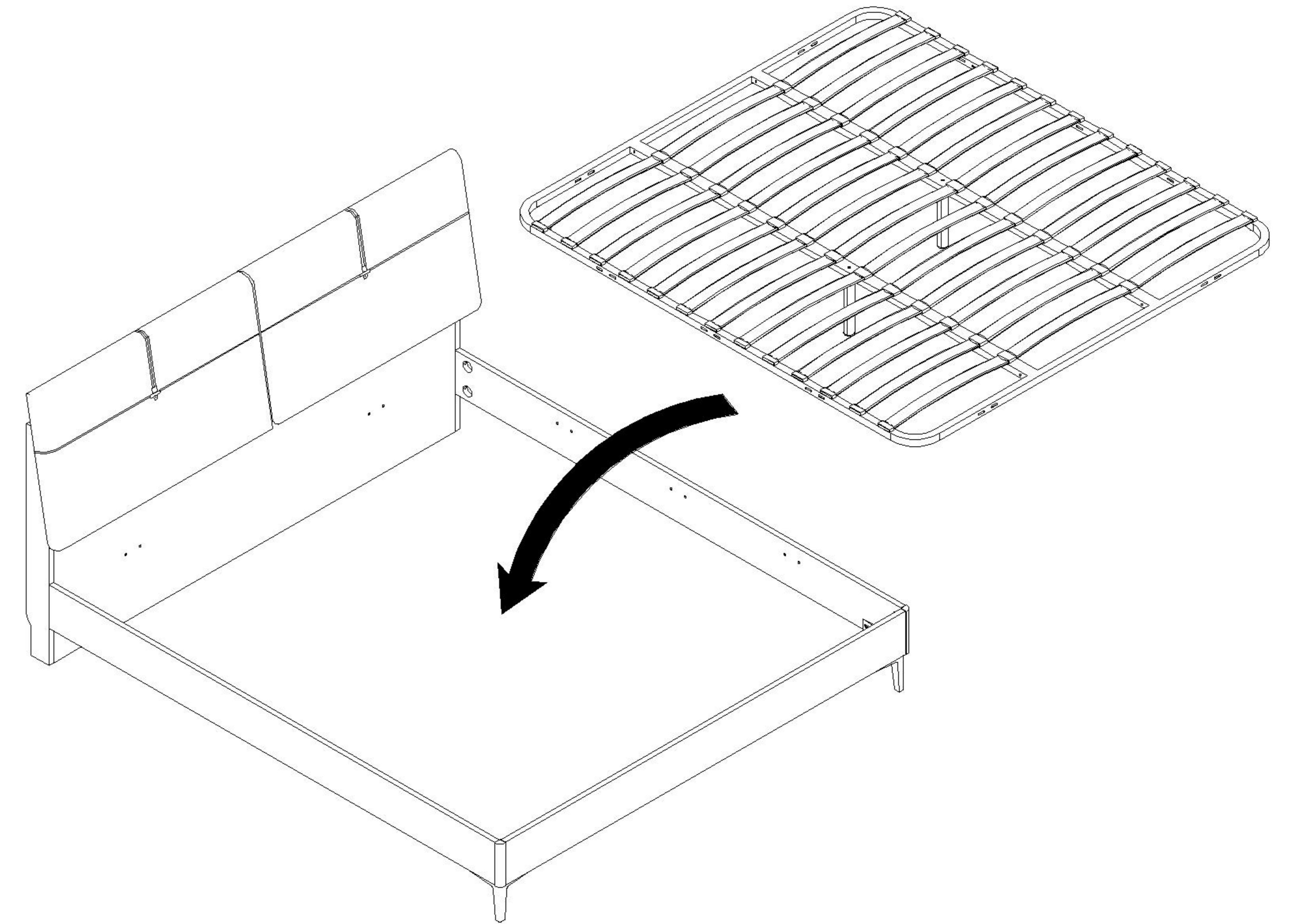

9

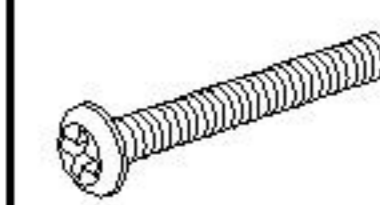

(R)\*20

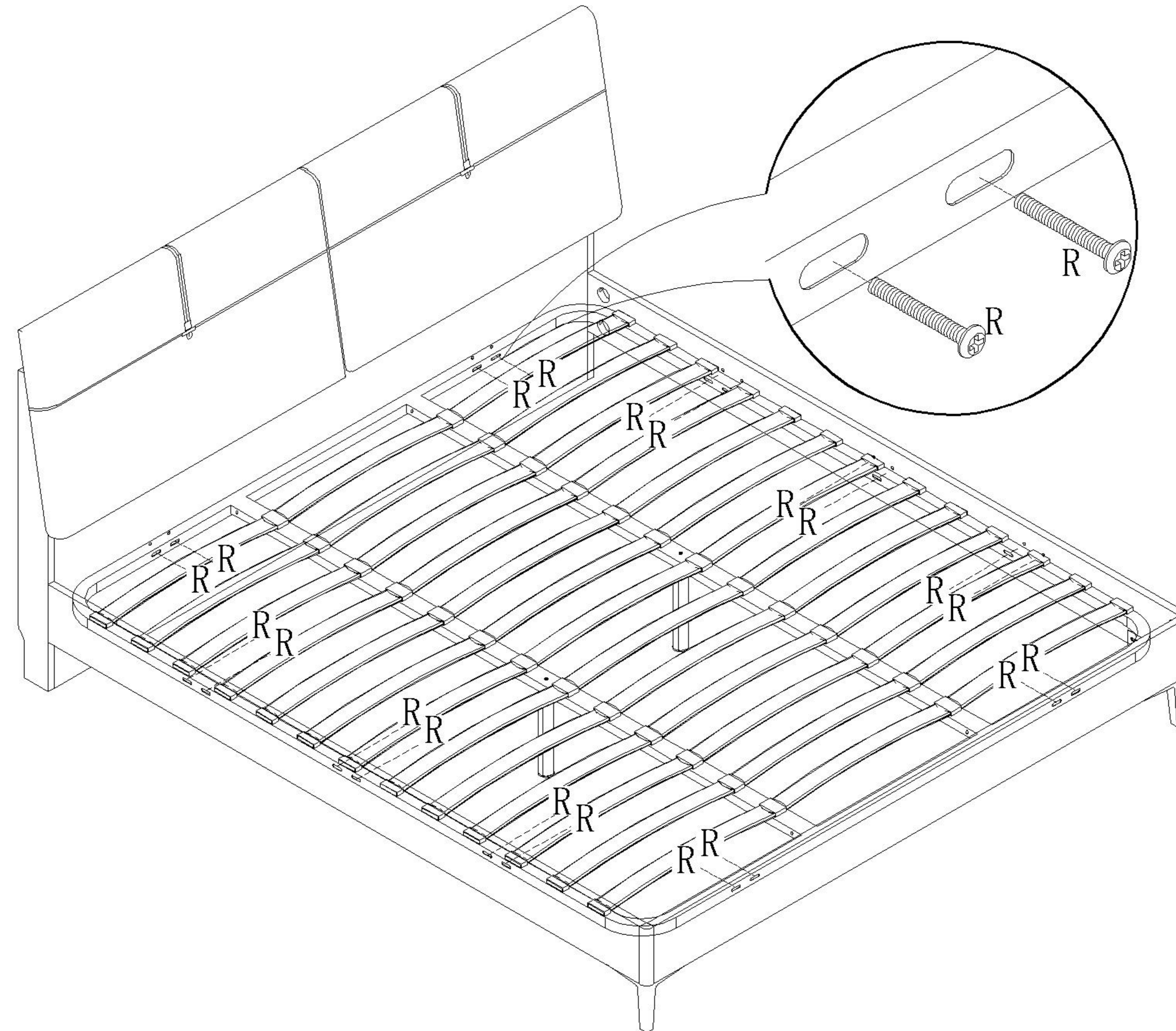

10