

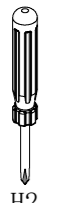

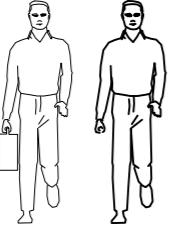





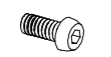
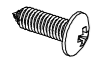

# LINSY 林氏家居

## 安装示意图/Assembly Instruction

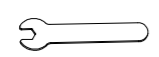
产品名称 Model NO.	BG047-ABC 1.2m电动升降桌 1.2M Electric Lift Table	产品规格 Specification	1200*600*698-1198mm
-------------------	--	-----------------------	---------------------

安装工具 Tool	 H1	 H2	安装人员 Installer	
--------------	---	---	-------------------	---

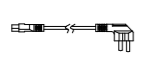
## 配件表 Accessories list

 (A)*12 内六角平圆头 M6*25mm M6*25 hexagon flat round head	 (B)*4 内六角沉头M6*16mm M6*16 hexagonal countersunk	 (C)*4 内六角平圆头M6*10mm M6*10 hexagon flat round head
 (D)*14 自攻钉ST5*16 ST5*16*14 hexagon flat round head	 (E)*1 M4内六角扳手 internal hexagonal wrench	 (F)*1 开口扳手 open wrench
 (G)*4 线扣 Wire buckle	 (H)*1 手控器 hand controller	 (I)*1 电源适配器 Power Adapter
 (J)*1 适配器挂架 adapter hanger	 (K)*1 电源线(国际) power supply	 (L)*2 过线盖 cover line
 (M)*1 转接线1300mm connecting cable		

### 部件表 Parts List

编号 NO.	名称 Name	规格 Specification	数量 QTY	材质 Material
1	左腿 left leg	643*80*50/575*75*45	1	冷轧钢 cold-rolled steel
2	右腿带电机 Prrts right leg	643*80*50/575*75*45	1	冷轧钢 cold-rolled steel
3	地脚组件 base	596*70*18	2	冷轧钢 cold-rolled steel
4-1	横梁-左(带垫块) 4-1 L-Crossbeam	450*40*20	1	冷轧钢 cold-rolled steel
4-2	横梁-右(带垫块) 4-2 R-Crossbeam	450*40*20	1	冷轧钢 cold-rolled steel
5	连接杆 Connecting rod	927*30*15	1	冷轧钢 cold-rolled steel
6	侧板(带垫块) Side board	480*50*33	2	酸洗板 pickling plates
7	传动杆组件 drive lever assembly	669	1	铝 aluminium
8	整板面板 panel	1200*600*18	1	刨花板 particleboard

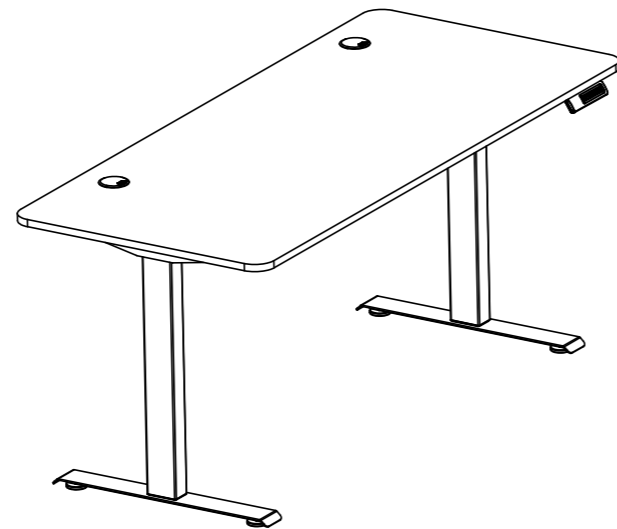

为了方便您组装，组装时请勿将螺丝锁紧，待全部零件锁上后，再行锁紧。  
In order to facilitate your assembly, do not assemble Tighten the screws, and when all the parts are locked, Lock it again.

### 1

(A)\*8 内六角平圆头 M6\*25mm  
M6\*25 hexagon flat round head

(E)\*1 M4内六角扳手  
internal hexagonal wrench

### 2

(A)\*4 内六角平圆头 M6\*25mm  
M6\*25 hexagon flat round head

(E)\*1 M4内六角扳手  
internal hexagonal wrench

水平对齐  
Horizontal alignment

竖直对齐  
vertical alignment

### 3

(C)\*4 内六角平圆头M6\*10mm  
M6\*10 hexagon flat round head

(E)\*1 M4内六角扳手  
internal hexagonal wrench

### 4

(F)\*1 开口扳手  
open wrench

塑料盖与标记对齐

如图所示，左旋拧松  
调整好长度后，右旋拧紧

### 5

(B)\*4 内六角沉头M6\*16mm  
M6\*16 hexagonal countersunk

(E)\*1 M4内六角扳手  
internal hexagonal wrench

### 6

(D)\*14 自攻钉ST5\*16\*14  
ST5\*16\*14 hexagon flat round head

(I)\*1 电源适配器  
Power Adapter

(H)\*1 手控器  
hand controller

(J)\*1 适配器挂架  
adapter hanger

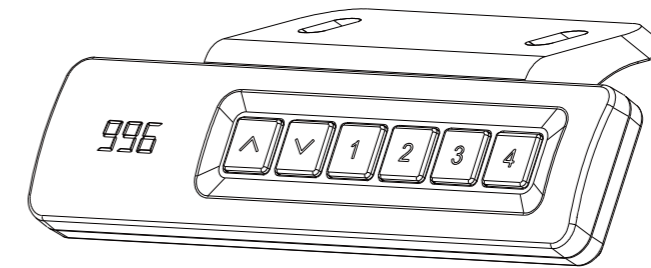
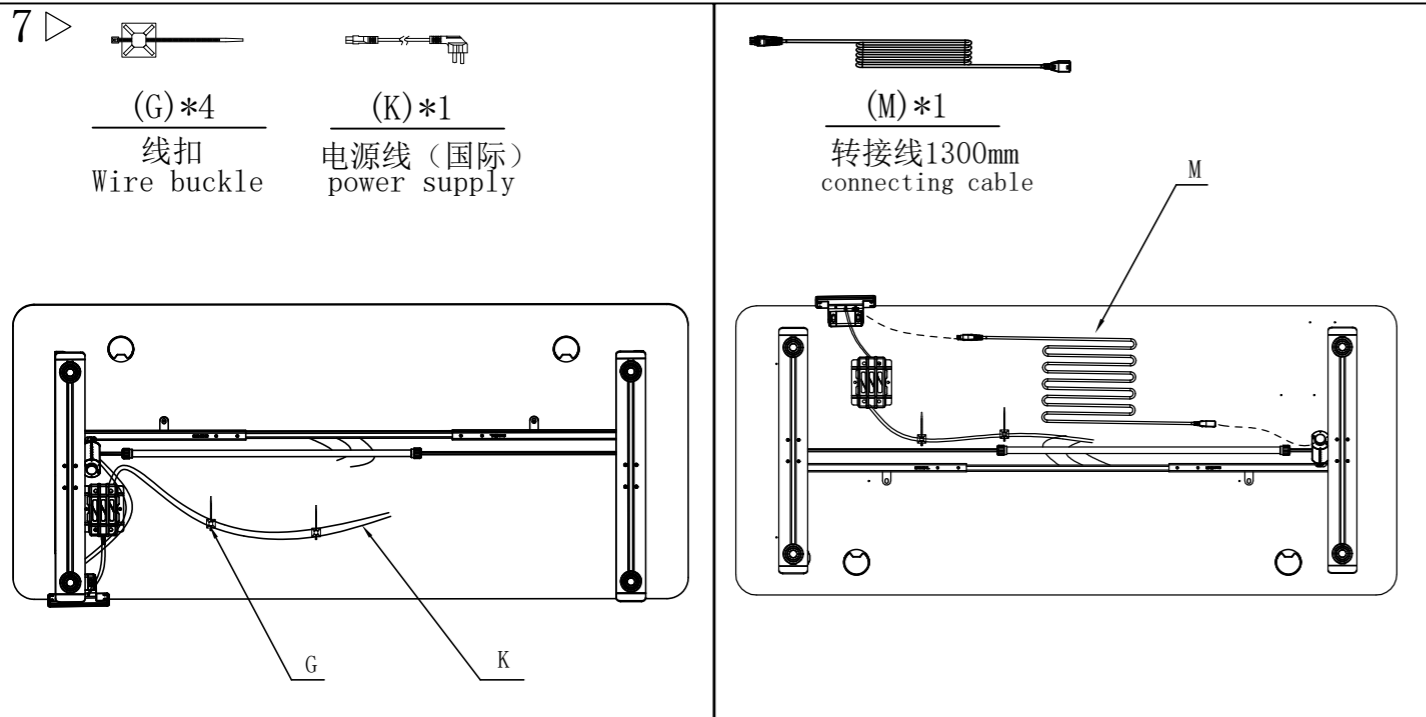

## 手控器使用说明

### 1. 操作方法:

按上升键“^” 立柱上升，按下降键“v” 立柱下降，松开按键动作停止。

### 2. 记忆位置功能:

长按“①/②/③/④”键 保持3 秒，显示屏数字闪烁 3 次后停止闪烁，存储记忆位置成功。

### 3. 设置下限位:

调整升降桌高度后，同时按住“v”和 ① 键保持3s，显示屏显示“-d0”，表明最低限位设置成功。

### 4. 设置上位位:

调整升降桌高度后，同时按住“^”和①键保持3s，显示屏显示“- UP”，表明最高限位设置成功。

### 5. 取消下限位:

在最低点显示屏显示“- L0”状态下，同时按“v”+①键保持3s，显示屏闪烁“- d0”后，下限位取消。

### 6. 取消上位位:

取消上位位设定：在最高点显示屏显示“-HI”状态下，同时按“^”+①键保持3s，显示屏闪烁“- UP”后，上位位取消。

### 7. 锁定:

在正常操作模式下，同时按住 ① 和 ② 键保持3秒，显示屏显示 LOC，手控器成功 锁定。

### 8. 解锁:

在 LOC 锁定状态下，同时按住①和②键保持3秒，显示屏重新显示数字，手控器成 功解锁。

## 9. 复位功能:

(1) 功能说明: 系统在特定情况下需要进行复位。情况包括:

- ①第一次使用, 系统上电进入复位状态。
- ②主动复位进入复位状态。
- ③系统异常进入复位状态。

(2) 操作方式: 长按下降键到底, 接着松开按键后再按下降键保持5秒, 手控器显示“RST”, 松开按键后长按下降键直至显示屏显示数字。

## 10. 显示屏厘米和英寸切换:

同时按住①和③键保持3s, 数显单位完成切换。

## 11. 遇阻回退灵敏度选择:

在正常操作模式下, 同时按住①键+④键保持3s, 显示屏显示“S0X”并闪烁(X表示当前灵敏度档位), 此时通过“^”和“v”调整档位, 调整完成后同时按住①键+④键保持3s, 显示屏停止闪烁并在3s后恢复正常高度显示。

灵敏度共有4档:

- 1—非常灵敏
- 2—一般灵敏
- 3—不灵敏
- 0—无灵敏度

## 12. 电机过流保护:

数码管显示 E01。当控制器处于过流保护时, 可进行主动复位完成复位操作后继续使用。

## 13. 工作制保护:

显示屏显示H01。当升降桌进入工作制保护时, 需等待 1-17 分 30秒后方可恢复工作。当手控器显示高度时, 此时升降桌可正常运行。

## 14. 错误保护:

先人为排除升降桌是否存在异常, 再进行复位, 如果升降桌已经发现倾斜或操作过程中发生倾斜, 立即停止操作联系售后人员处理。

# Manual control device instructions

## 1. lifting function:

Press and hold the “^” button, the desk goes up, press and hold the “v” button, the desk goes down, and release the button to stop.

## 2. Memory position function:

Press and hold the ①/②/③/④ button for 3 seconds, the number on the display will flash 3 times and then stop flashing, indicating that the memory position is stored successfully.

## 3. Set the lower limit:

After adjusting the height of the desk, press and hold the “v” and ① buttons together for 3 seconds, and “-dO” appears on the display, indicating that the lower limit is set successfully.

## 4. Set the upper limit:

After adjusting the height of the desk, press and hold the “^” and ① buttons together for 3 seconds, and “-UP” appears on the display, indicating that the upper limit is set successfully.

## 5. Cancel the lower limit:

When the lowest point display shows “-LO”, press the “v” and ① buttons together for 3 seconds, after the display flashes “-dO”, the lower limit is canceled.

## 6. Cancel the upper limit:

When the highest point display shows “-HI”, press the “^” and ① buttons together for 3 seconds, after the display flashes “-UP”, the upper limit is canceled.

## 7. Locking:

In normal operation mode, press and hold the ① and ② buttons together for 3 seconds, LOC will appear on the display, and the handset is successfully locked.

## 8. Unlock:

In the LOC locked state, press and hold the ① and ② buttons together for 3 seconds, the display will re-display the number, and the handset is successfully unlocked.

## 9. Reset:

(1) Function description: The system needs to be reset under specific circumstances. The situation includes:

- ① The first time it is used, the system is powered on and enters a reset state.
- ② Active reset enters the reset state.
- ③ The system has entered a reset state due to abnormal conditions.

(2) Operation method: Long press and hold the down button to the bottom, then release the button and hold the down button for 5 seconds. The manual control displays "RST", and after releasing the button

Press the down button until the display shows a number.

## 10. Switching between centimeters and inches:

press and hold the ① and ③ buttons for 3 seconds, and the digital display unit completes the switching.

## 11. Set anti-collision sensitivity:

In the normal operation mode, press and hold the ① and ④ buttons for 3 seconds together, the display will display "S0X" and flash (X indicates the current sensitivity gear), at this time, adjust through “^” and “~” buttons, after the adjustment is completed, press and hold ① and ④ buttons for 3s together, the display will stop flashing and return to normal altitude display after 3s.

## There are 4 levels of sensitivity:

- 1 - very sensitive
- 2 - Fairly sensitive
- 3 - insensitive
- 0 - no sensitivity

## 12. Motor overcurrent protection:

the display shows E01. When the desk is under overcurrent protection, it can be actively reset, and the desk can be used normally after the reset operation is completed.

## 13. Working system protection:

The display shows H01. When the desk enters the working mode protection, it needs to wait for 1-17 minutes and 30 seconds before resuming work. When the height is displayed on the handset, the desk can operate normally.

## 14. Error protection:

First, manually eliminate whether there is any abnormality in the desk, and then reset it. If the desk has been found to be tilted or tilted during operation, immediately stop the operation and contact the after-sales personnel to deal with it.