

# LINSY 林氏家居

## 安装示意图/Assembly Instruction

产品名称 Model NO. BS104-A#



产品规格 Specification 单人  
Individual

尺寸组合 Combined size 1220\*850\*780mm

成品 部件明细	编号 NO.	名称 Name	规格 Specification	数量 QTY	材质 Material
Finished Parts Details	1	单人 Individual	1220*850*780mm	1	实木-夹板-海绵-科技布 Solid wood - plywood - sponge - technology cloth
	2				

制图 Draw C20

### 配件表 Accessories list

编号NO.	名称 Name	图示 Icon	数量 QTY	单人 Individual
A	说明书(含安装图) Mounting Instruction (with drawing)		1	1
B	脚-(直径60*60*145-160mm)带铁片可调一字五金脚 Foot -(diameter 60*60*145-160mm) with iron sheet adjustable character metal foot		4	4
C	M5*30自攻螺丝 M5*30 self tapping screw		16	16
D				
E				
F				
G				

如何区分沙发的左右方向?  
How to zone the left and right direction of the sofa?

(图示仅供分辨方向用/Picture are for orientation only)

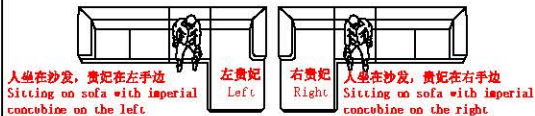

安装人数  
Installer



充电式手电钻Cordless hand drill  
或者Or  
十字螺丝刀Phillips screwdriver

客户安装前须知:  
Customers need to know before installation:  
此安装图为“单人”的位置关系。  
This installation picture is "Individual"

1-1

### 单人 Individual

STEP 1:



图1: 拉开拉链, 取出配件箱  
Figure 1: Unzip the accessory case



图2: 边脚安装示意图  
Figure 2: Side and foot installation diagram

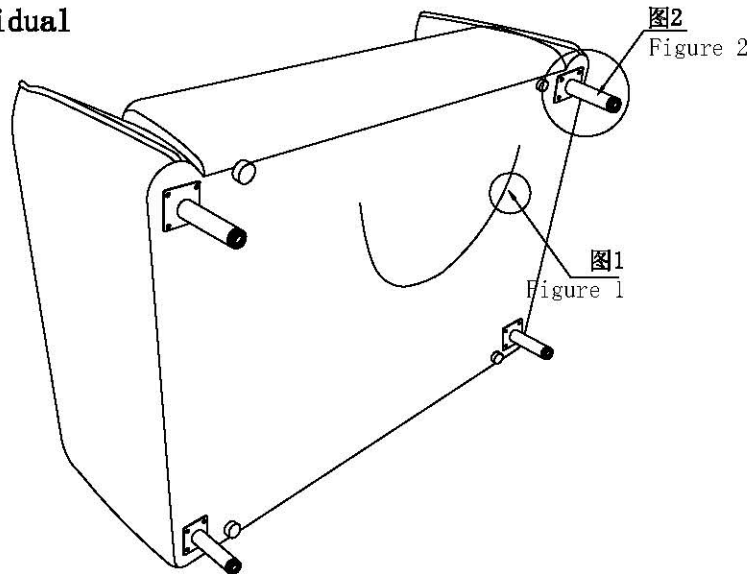

### 组合图 Combination

单人 Individual

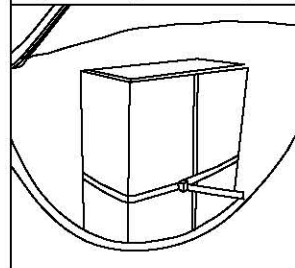
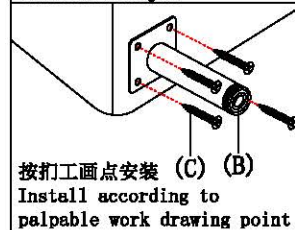