

LINSY 林氏家居

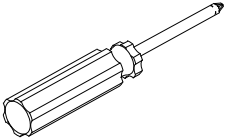

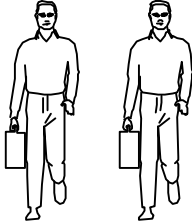





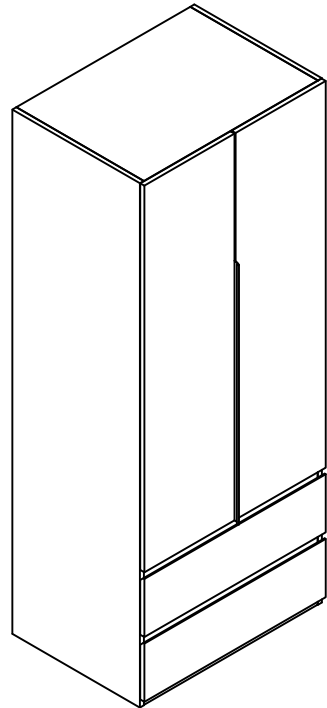

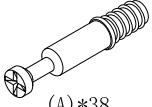

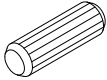

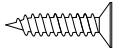

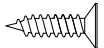
五金表/Hardware list

部件表/Parts List

安装示意图/Assembly Instruction

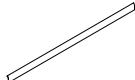
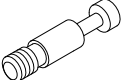
产品名称 Model NO.	OI3D-A
产品规格 Specification	802*606*2003MM
安装工具 Tool	安装人数 Installer
	

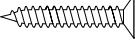

 (A)*38 二合一螺杆 2-in-1-screw	 (B)*38 大三合一锁饼 3-in-1 large lock	 (C)*13 木榫-(ϕ 8*30mm) Wood tenon	 (D)*1 白色透气孔盖 Breathable cover
 (E)*4 自攻螺丝M3.5*16 Tapping screw	 (F)*4 背板扣 White buckle	 (G)*4 自攻大扁M4*30mm Flat head tapping screw	 (H)*38 自攻螺丝M3.5*12 Tapping screw
 (I)*2 挂衣托 Clothes hanger	 (J)*1 挂衣杆L=758mm Clothes rail	 (K)*6 直弯缓冲门铰-杯径 ϕ 35 Straight bend hinge	 (L)*8 层板托5mm shelf support
 (M)*8 脚垫-灰色毛毡 Foot pad	 (N)*1 拉手 Handle	 (O)*13 小二合一杆 2-in-1 small rod	 (P)*13 小三合一锁饼 3-in-1 small lock
 (Q)*13 塑料螺母 Plastic Nut	 (R)*13 自攻螺丝-(M4*40mm) Tapping screw	 (S)*2 导轨14寸 Three-section rail	

编号NO.	名称Name	规格(MM) Specification	数量QTY	材质Material
1	面板Top panel	766*562*18	1	三胺板 Melamine
2	底板Bottom board	766*562*18	1	三胺板 Melamine
3	右侧板Side board(R)	2000*562*18	1	三胺板 Melamine
4	左侧板Side board(L)	2000*562*18	1	三胺板 Melamine
5	背拉条Back brace	1906*140*18	2	三胺板 Melamine
6	背板Back board	1916*496*5	1	三胺板 Melamine
7	前脚条 Front foot strip	766*58*18	2	三胺板 Melamine
8	层板Shelf	765*537*18	2	三胺板 Melamine
9	拉条Brace	766*58*18	2	三胺板 Melamine
10	右门板Door board(R)	1475*398*18	1	三胺板 Melamine
11	左门板Door board(L)	1475*398*18	1	三胺板 Melamine
12	抽屉面板 Drawer's top panel	799*222*18	2	三胺板 Melamine
13	抽屉左侧板 Drawer's side board(L)	395*142*12	2	三胺板 Melamine
14	抽屉右侧板 Drawer's side board(R)	395*142*12	2	三胺板 Melamine
15	抽屉后板 Drawer's Back board	716*142*12	2	三胺板 Melamine
16	抽屉底托条 Drawer's bottom bracket	381*58*12	2	三胺板 Melamine
17	抽屉底板 Drawer's Bottom board	726*391*5	2	三胺板 Melamine

OI3D-A

安装方法/
Installation method

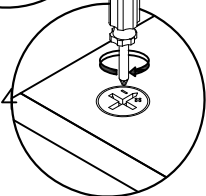
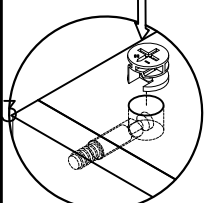
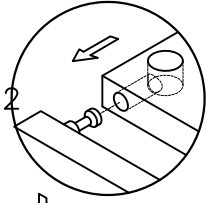
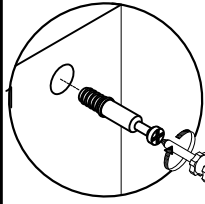

二合一
two-in-one

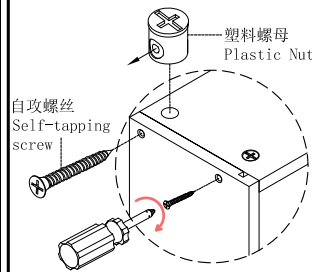

塑料螺母
Plastic Nut

- (O)*12
- (P)*12
- (Q)*12
- (R)*12

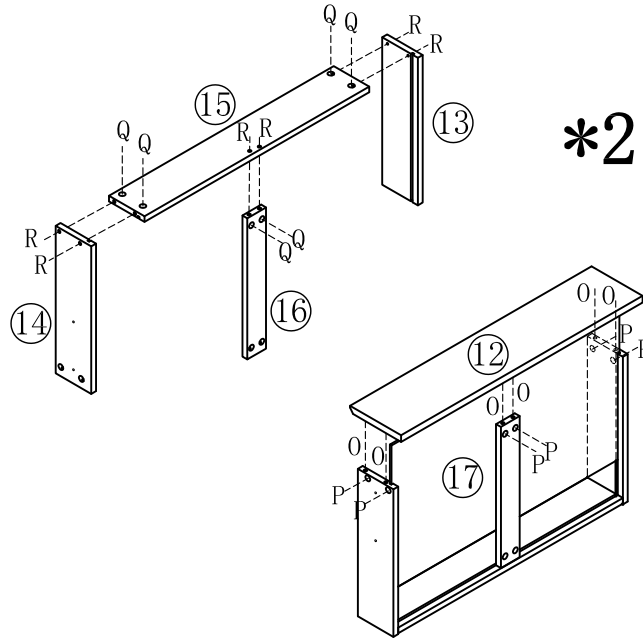

*2

1

- (H)*16
- (S)*2

2

*2

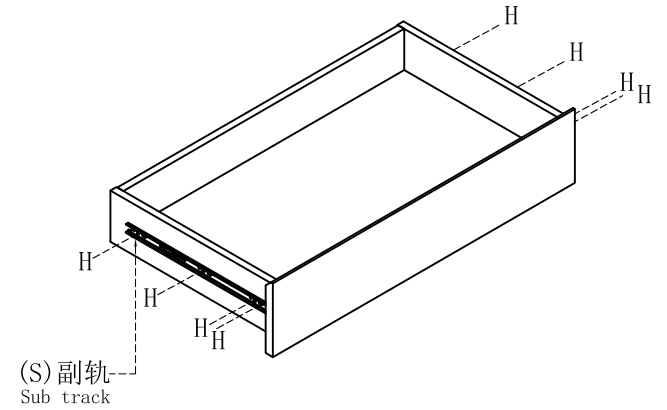

- (A)*4
- (B)*4
- (M)*4

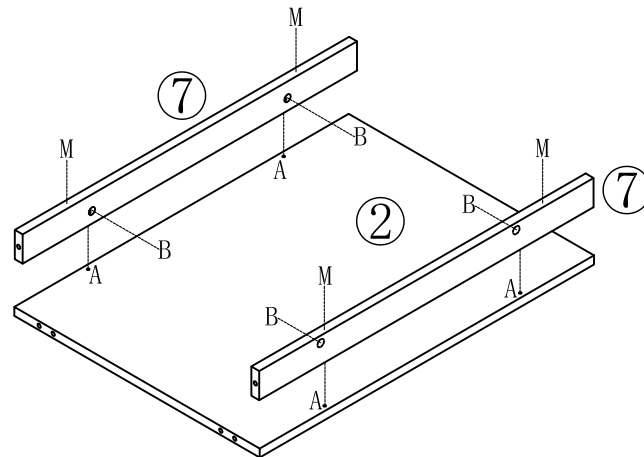

3

- (A)*8
- (B)*8
- (D)*1

4

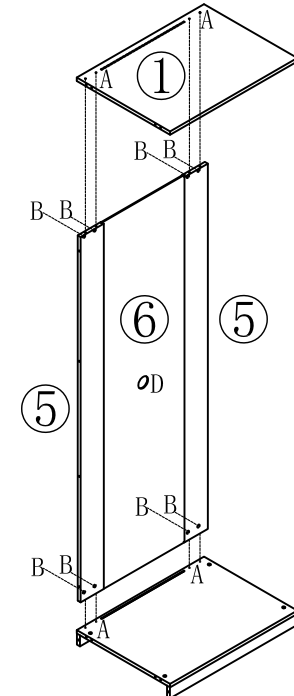

0I3D-A

安装方法/
Installation method

阀门开关(下压为开)
Valve switch (press down to open)

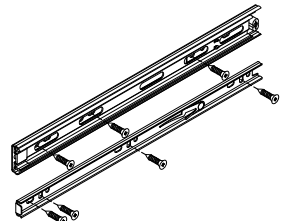
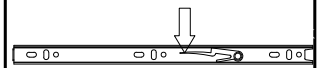

三节滚珠导轨-14"
Three Section Ball Guide-14"

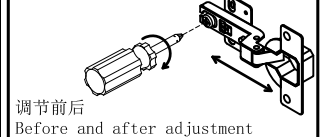
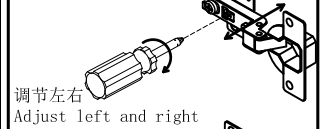
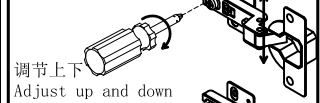
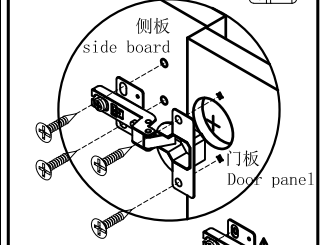
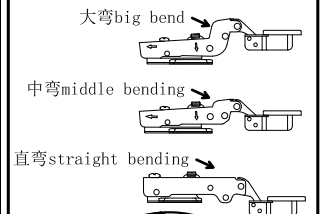

门铰
Hinge

- (A)*24
- (B)*24
- (C)*12
- (M)*4

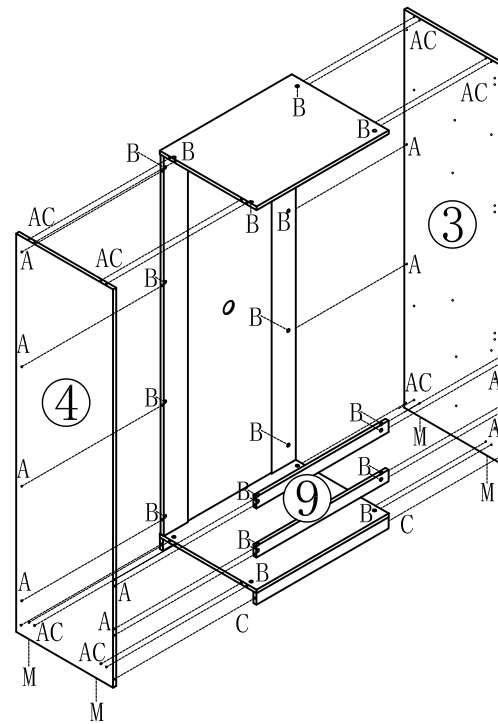

- (K)*6
- (N)*1
- (H)*4
- (G)*4

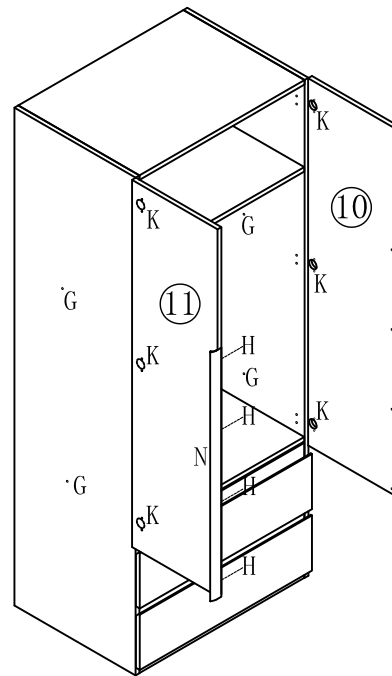

拉手可左右安装
Handle can be installed left and right

温馨提示:
安装完成后, 与要组合柜子在合适的位置用五金G锁紧
Tips:
After installation, lock the cabinet in place with metal G

5

- (H)*16
- (S)*2
- (L)*8
- (I)*2
- (J)*1

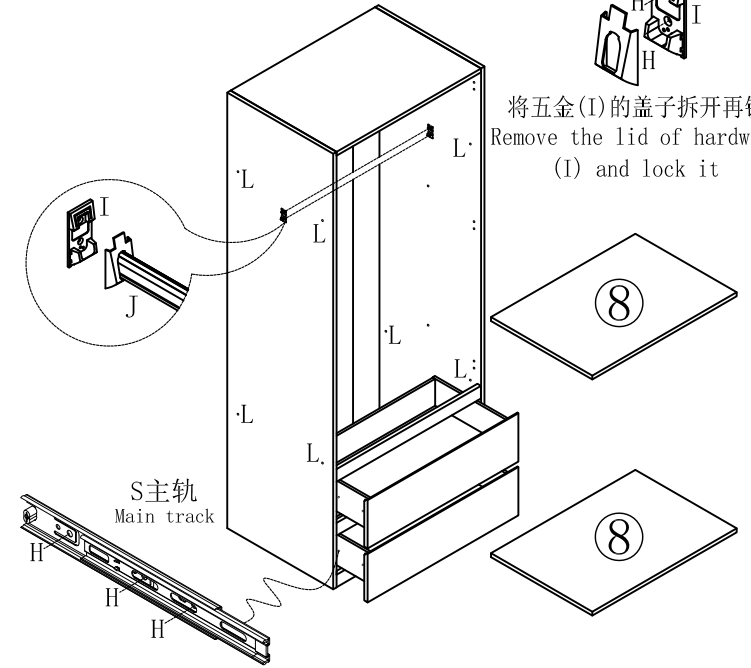

将五金(I)的盖子拆开再锁 (I) and lock it

7

- (E)*4
- (F)*4

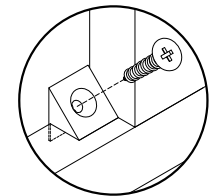
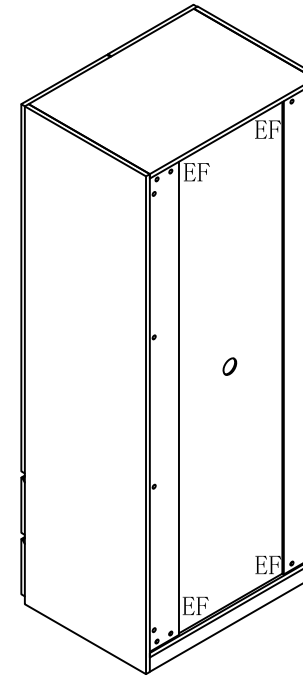

6

8