

充电式手电钻 或者 十字螺丝刀
Cordless hand drill
Phillips screwdriver

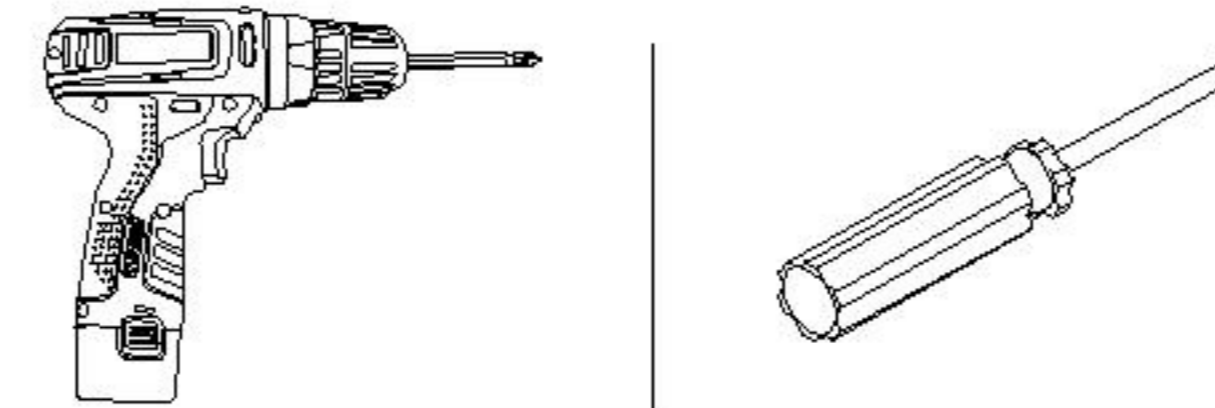

安装人数Installer

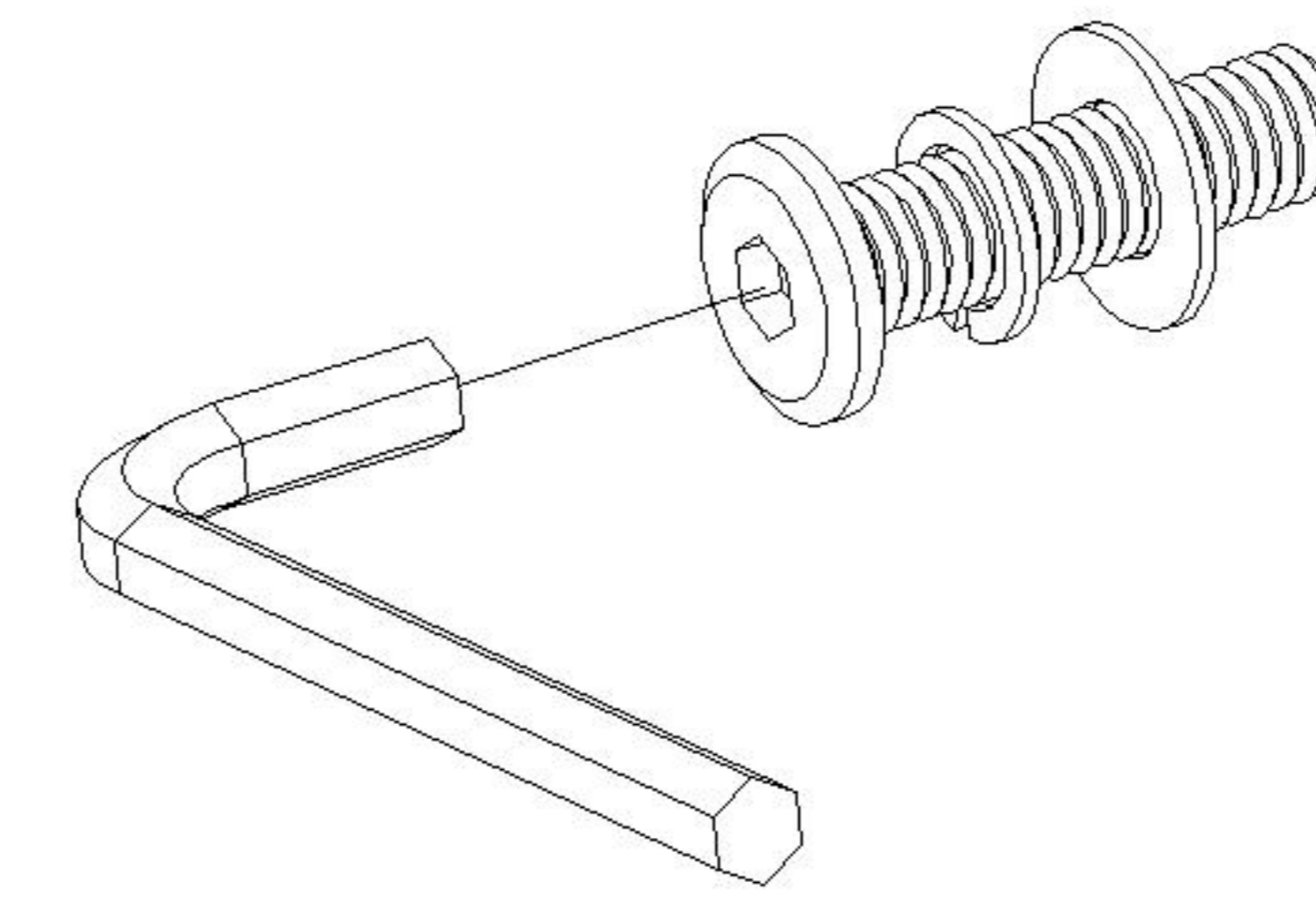
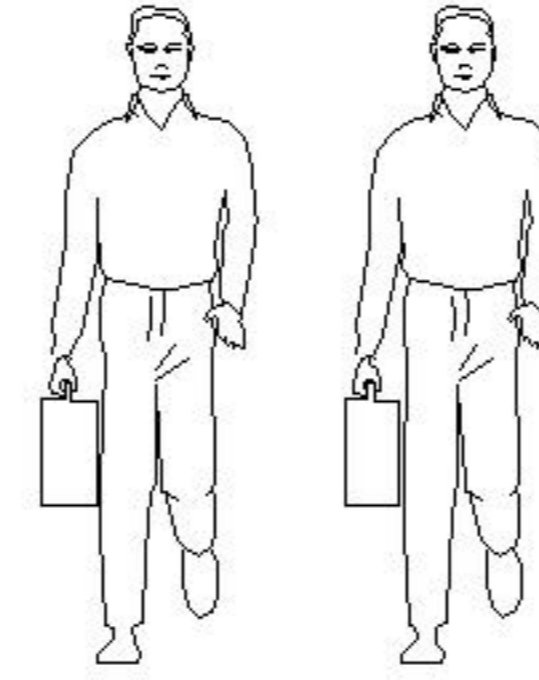

内六角螺丝垫片安装顺序
Installation sequence of hexagon socket screw gasket

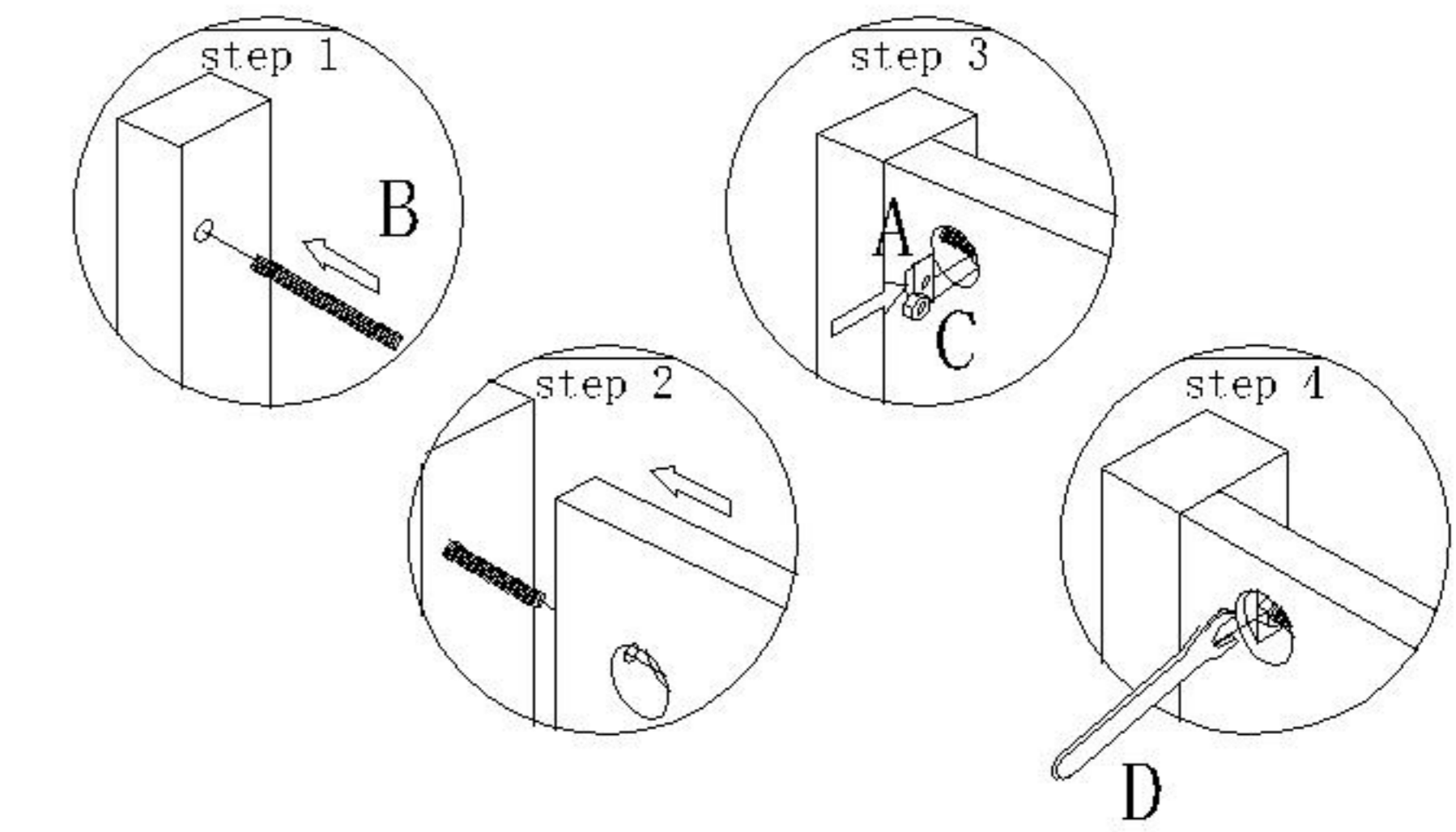

五合一的安装方法
Instruction of 5-in-1 screw

安装示意图/Assembly Instruction

产品名称 Model NO.	LH047A5-A
产品规格 Specification	1.5*2.0m
尺寸组合 Combined size	2100*1560*890mm

配件表/Accessories list 部件表/Parts List

编号NO.	名称Name	图示Icon	数量QTY	编号NO.	名称Name	规格Specification	数量QTY	材质material
A	半月牙 M6 Semilunar M6		12	①	床头组立 The head of a bed	1560*890*98	1	实木 Solid wood
B	全牙丝杆M6*80mm screw-(M6*80mm) color zinc		12	②	床尾 The end of the bed	1434*110*50	1	实木 Solid wood
C	M6外六角螺帽 M6 Outer hexagon nut		12	③	床尾腿 Bed tail leg	305*60*60	2	实木 Solid wood
D	M6套扳手 M6 Set wrench		1	④	左床边组立 Left bed top	1970*110*45	1	实木 Solid wood
E	5mm内六角扳手 spanner-(5mm) hex		1	⑤	右床边组立 Right bed top	1970*110*45	1	实木 Solid wood
F	M8锤型螺母 M8 hammer nut		4	⑥	床中横 Bed board support strip	2009*60*25	2	实木 Solid wood
G	M8*50内六角螺栓 M8*50 Hexagon socket bolt		4	⑦	床中腿 Middle foot of bed	220*36*36	4	实木 Solid wood
H	M8*13弹垫 shim-(M8*13mm) spring		4					
I	M8*16平垫 shim-(M8*16mm) colored zinc		4					
J	自攻螺丝4*35 Self-tapping screw-(M4*35mm)		4					

STEP 1

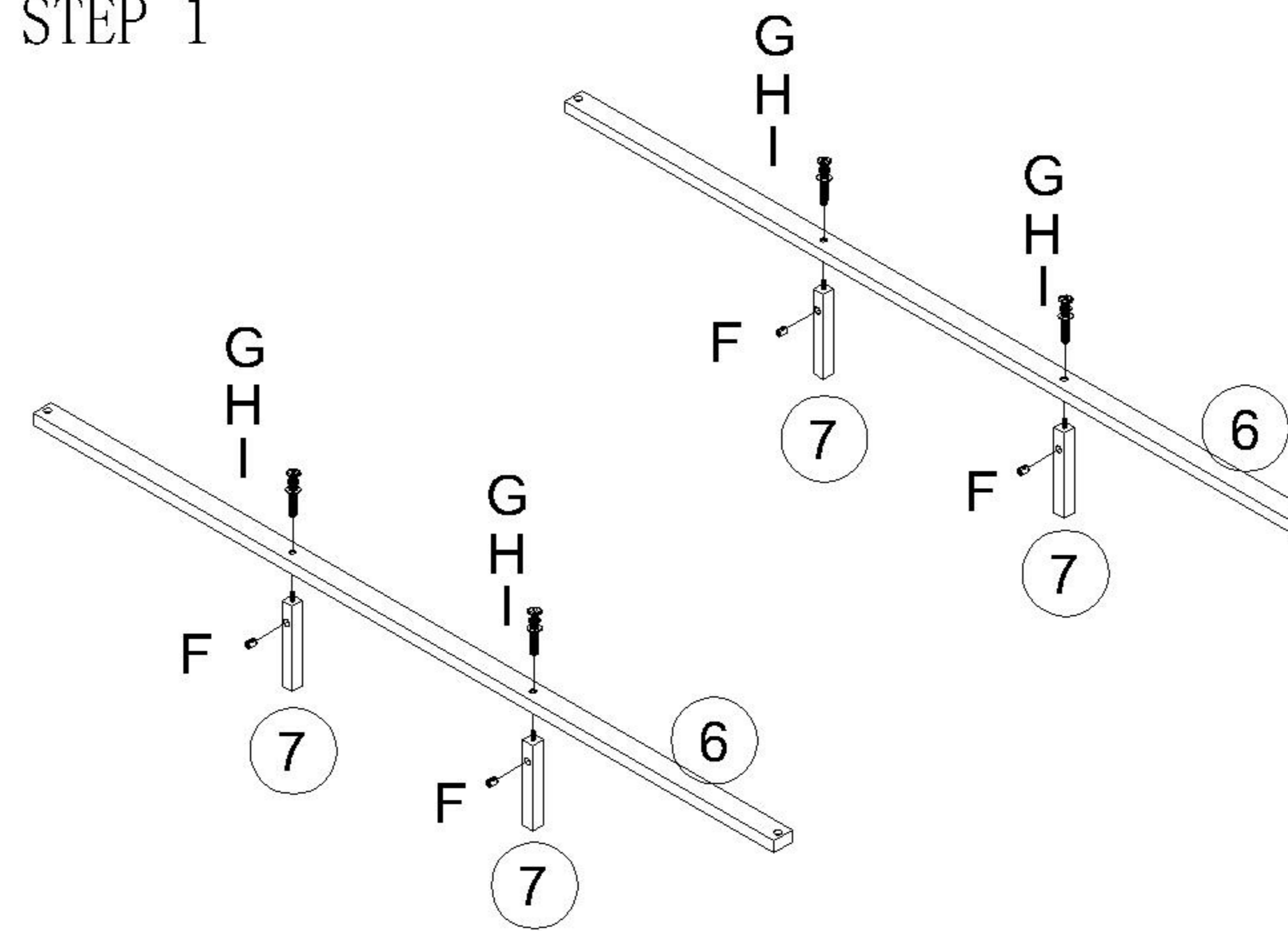

△ 使用五金F、G、H、I将部件6与部件7连接。

Connect part 6 to part 7 using hardware F, G, H and I.

STEP 2

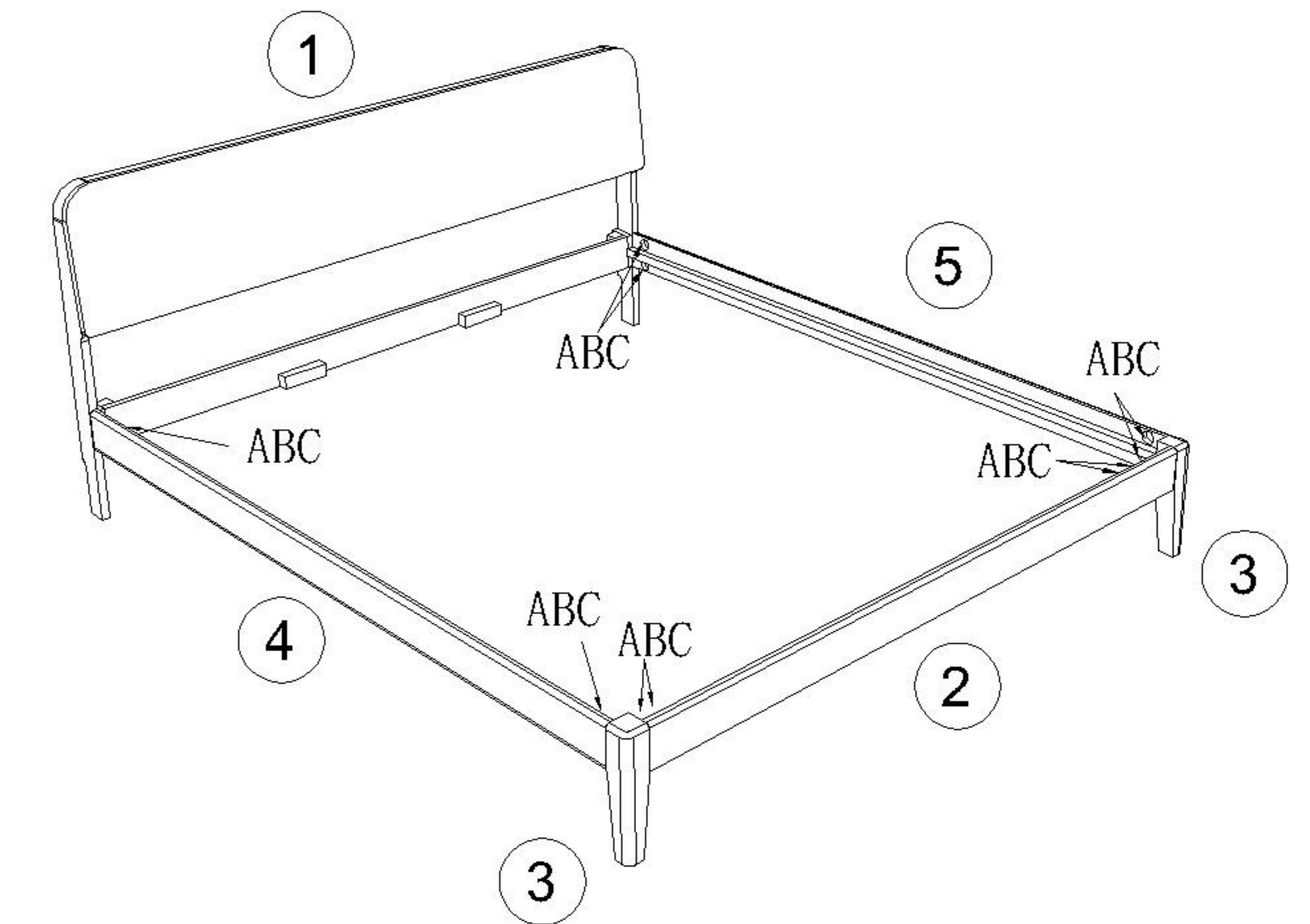

△ 使用五金A、B、C将部件1、部件2、部件3与部件4、部件5连接。

Connect part 1, part 2, part 3 to part 4, part 5 using hardware A, B and C.

STEP 3

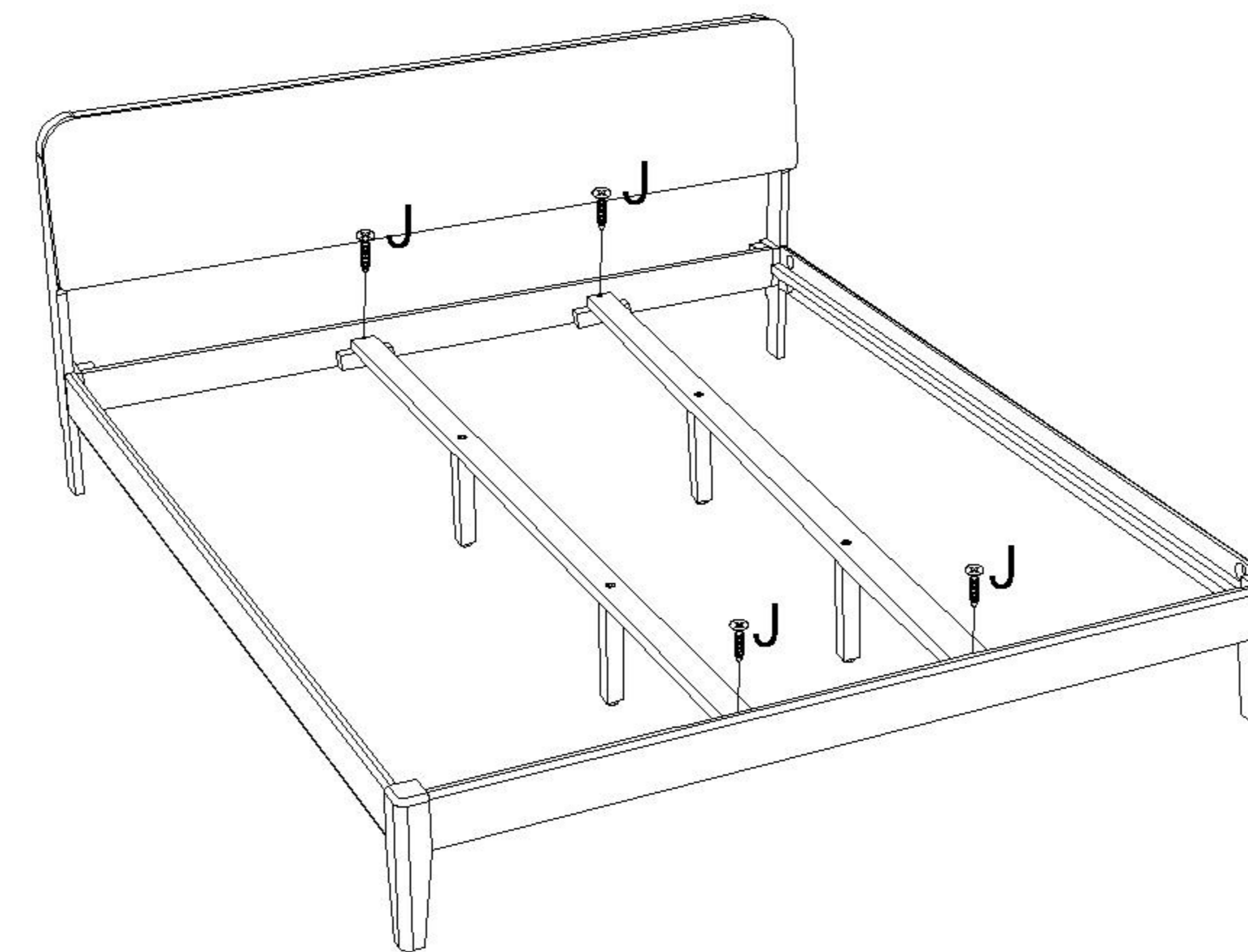

△ 将组好的STEP1和STEP2用五金J连接。

Connect the assembled STEP2 and STEP3 with hardware J.

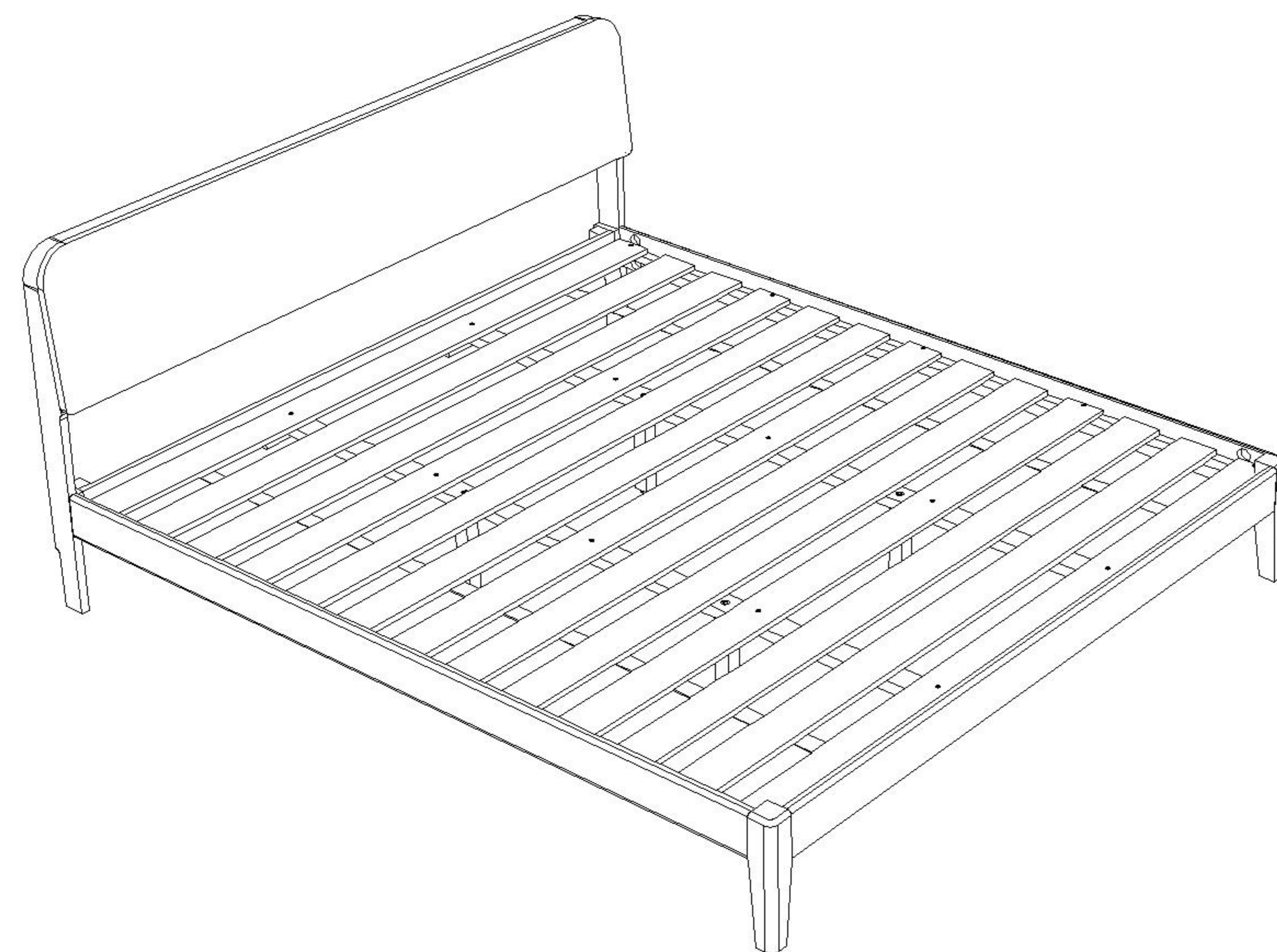

注：以下排骨架选配其中一种

Note: One of the following row frameworks is available

选择1: 实木床铺板001(1.5米)
Option 1: Solid wood bedding board 001(1.5m)

配件表/Accessories list				部件表/Parts List				
编号NO.	名称Name	图示Icon	数量QTY	编号NO.	名称Name	规格Specification	数量QTY	材质material
X	自攻螺丝4*35 Self-tapping screw-(M4*35mm)		17	⑪	实木床铺板001 Solid wood bedding board 001	1988*1507*30	1	实木 Solid wood

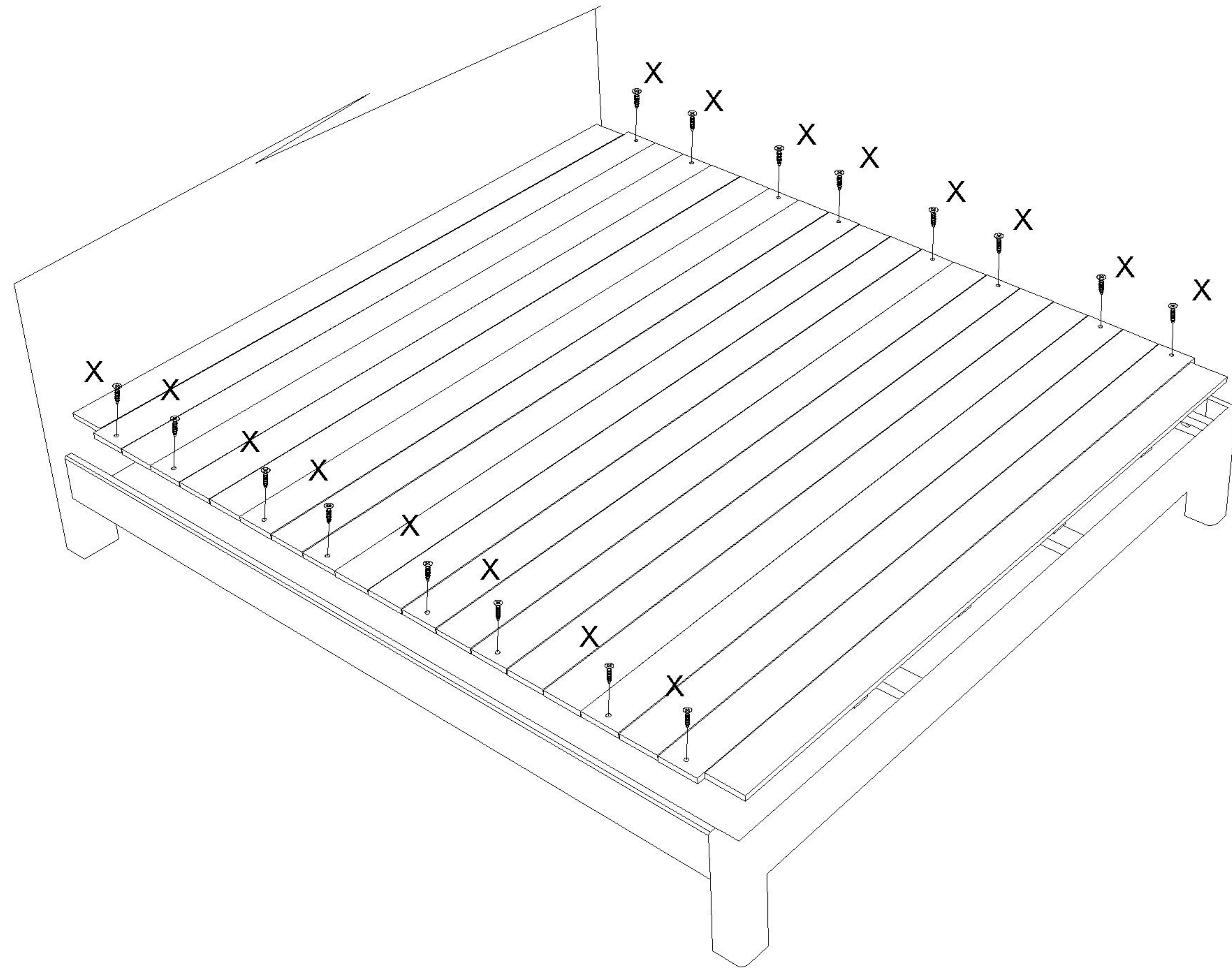

△ 将床铺板放在相应位置，并用五金X固定。

Place the bed board in the appropriate position, and secure it with hardware x.

选择2: 实木条形排骨架(1.5米)
Option 2: Solid wood strip frame(1.5m)

配件表/Accessories list				部件表/Parts List				
编号NO.	名称Name	图示Icon	数量QTY	编号NO.	名称Name	规格Specification	数量QTY	材质material
Y	自攻螺丝4*30 Self-tapping screw-(M4*30mm)		21	⑪	实木条形排骨架 Solid wood strip frame	2000*1507*15	1	实木 Solid wood

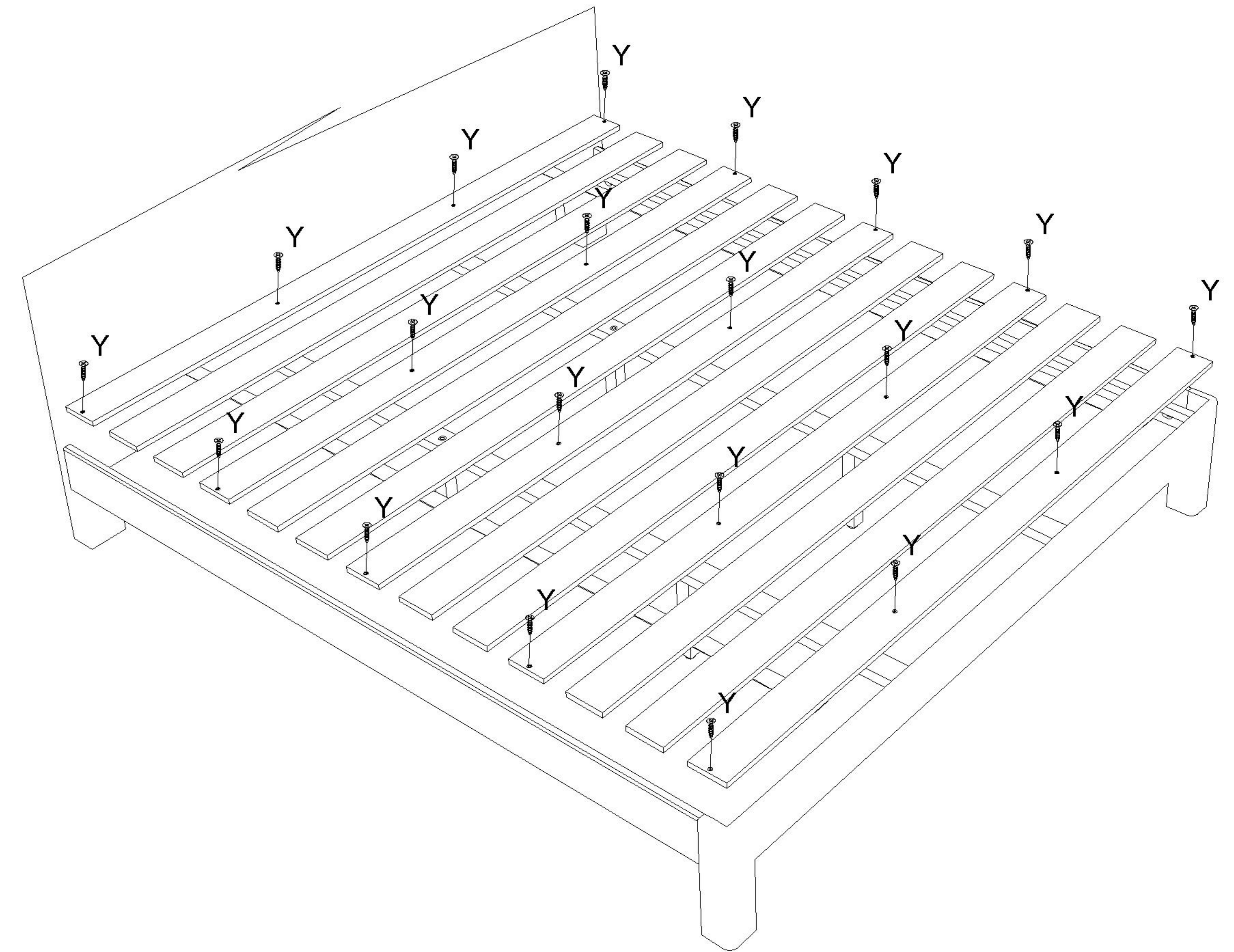

△ 将床铺板放在相应位置，并用五金Y固定。

Place the bed board in the appropriate position, and secure it with hardware x.