

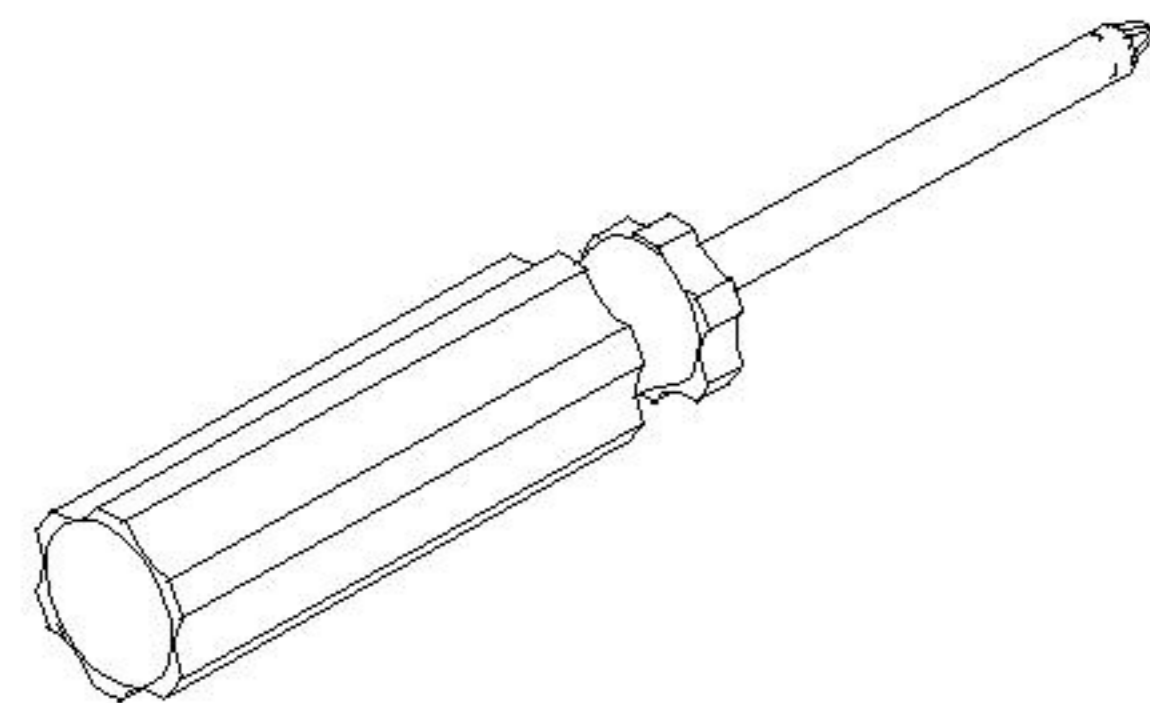
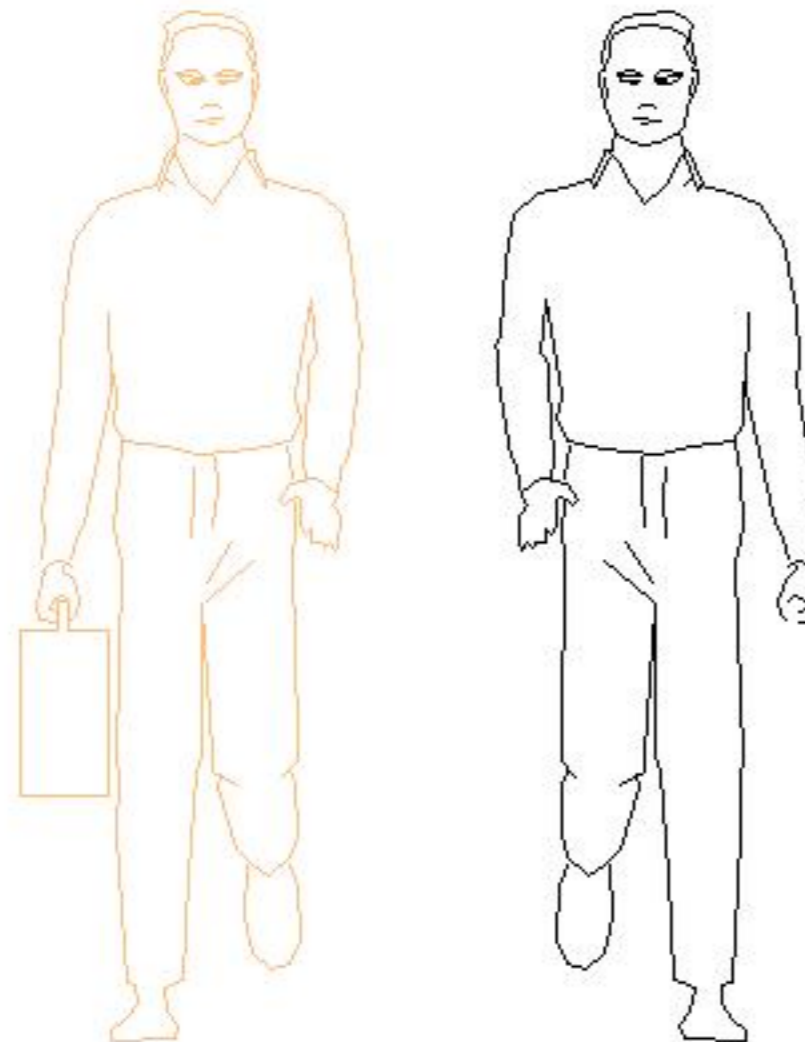
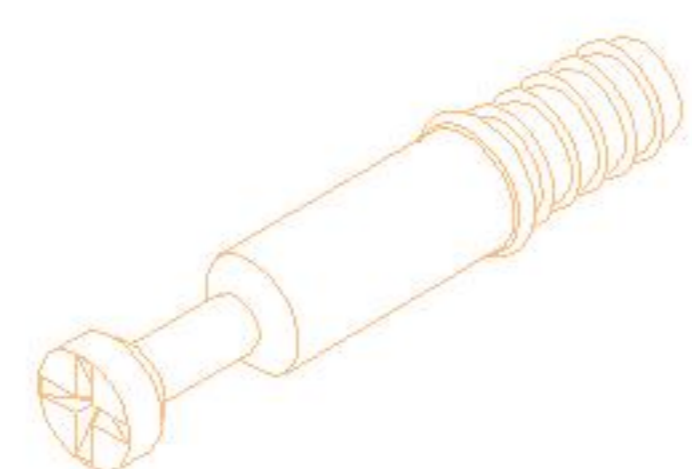
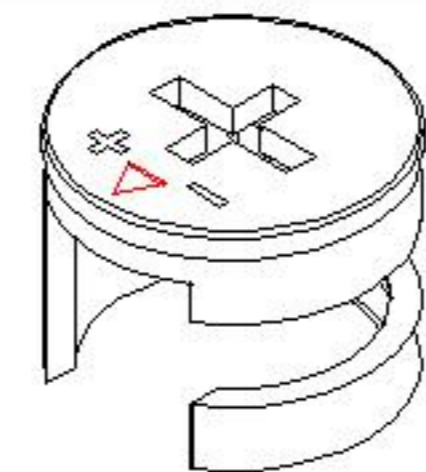
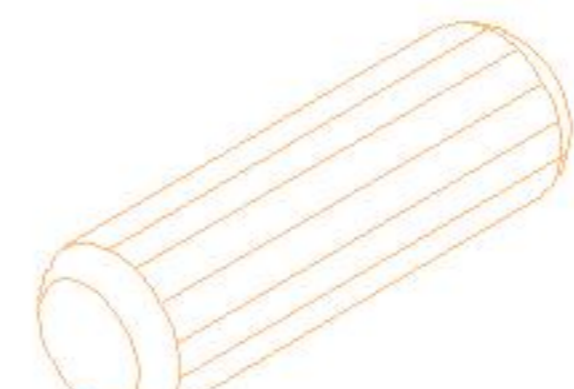
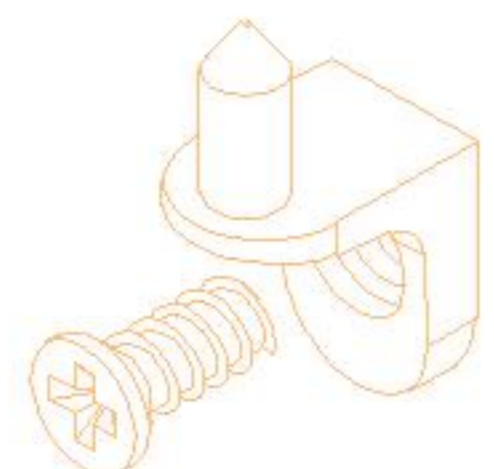
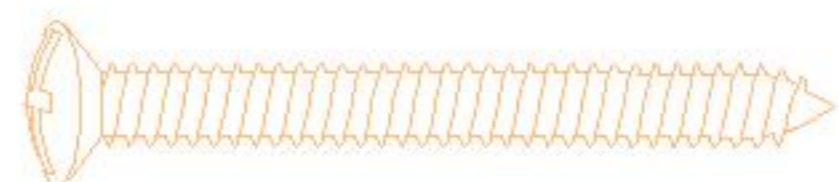

安装示意图/Assembly Instruction

产品名称 Model NO.	PK1X-C(0.8m)
产品规格 Specification	802*336*2001mm
安装工具 Tool	安装人数 Installer
	

 (A)*6 二合一螺杆 2-in-1-screw	 (B)*6 大三合一锁饼 Three-in-one large lock	 (C)*6 木榫-∅8*30 Wood tenon	 (D)*16 层板托 Shelf support
 (E)*14 大扁白攻M4*30mm Flat head tapping screw	 (F)*13 垫片-M5 Shim	 (G)*2 家具防倒器-白色 Anti-fall device	 (H)*6 灰色毛毡垫 Foot pad
 (I)*13 背板扣 White buckle	 (J)*13 白攻螺丝M3.5*16mm Tapping screw		

编号NO.	名称Name	规格 (mm) Specification	数量QTY	材质Material
①	面板 Top panel	802*330*18	1	实木 wood
②	底板 Bottom board	762*283*18	1	实木 wood
③	左侧板组立 Side board assembly(L)	1980*330*40	1	实木 wood
④	右侧板组立 Side board assembly(R)	1980*330*40	1	实木 wood
⑤	前拉条 Front brace	762*50*20	1	实木 wood
⑥	固定层板 Fixed shelf	762*260*18	1	实木 wood
⑦	活动层板 Movable shelf	761*260*18	4	实木 wood
⑧	背拉条 Back brace	1930*130*18	1	实木 wood
⑨	背板 Back board	1942*329*8	2	实木 wood
⑩	五金门 Hardware door	1924*378*38	2	铝合金+玻璃 aluminium alloy+Glass

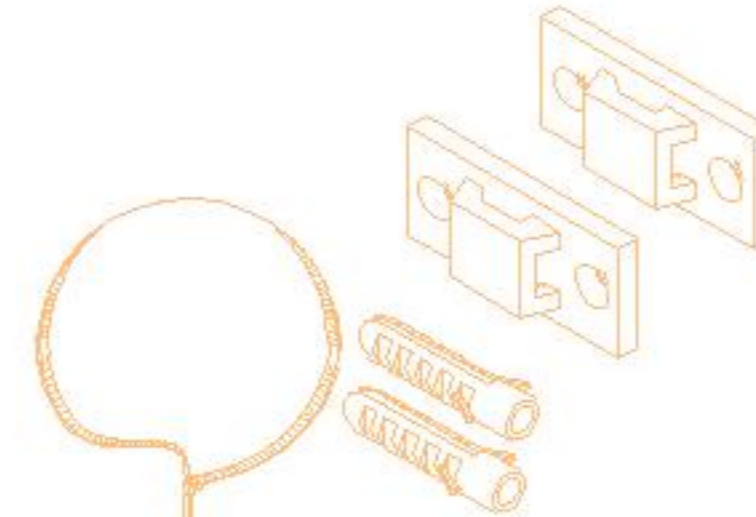
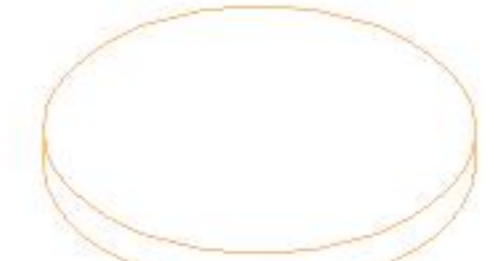
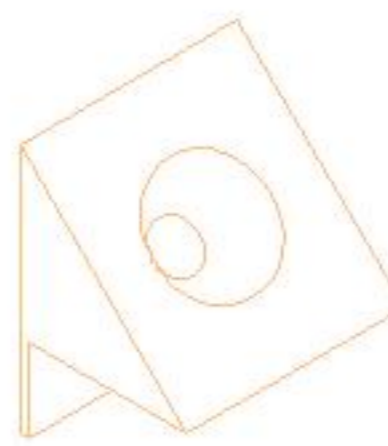
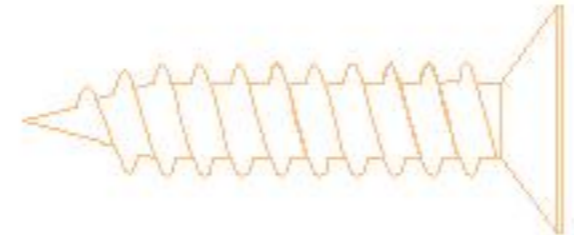
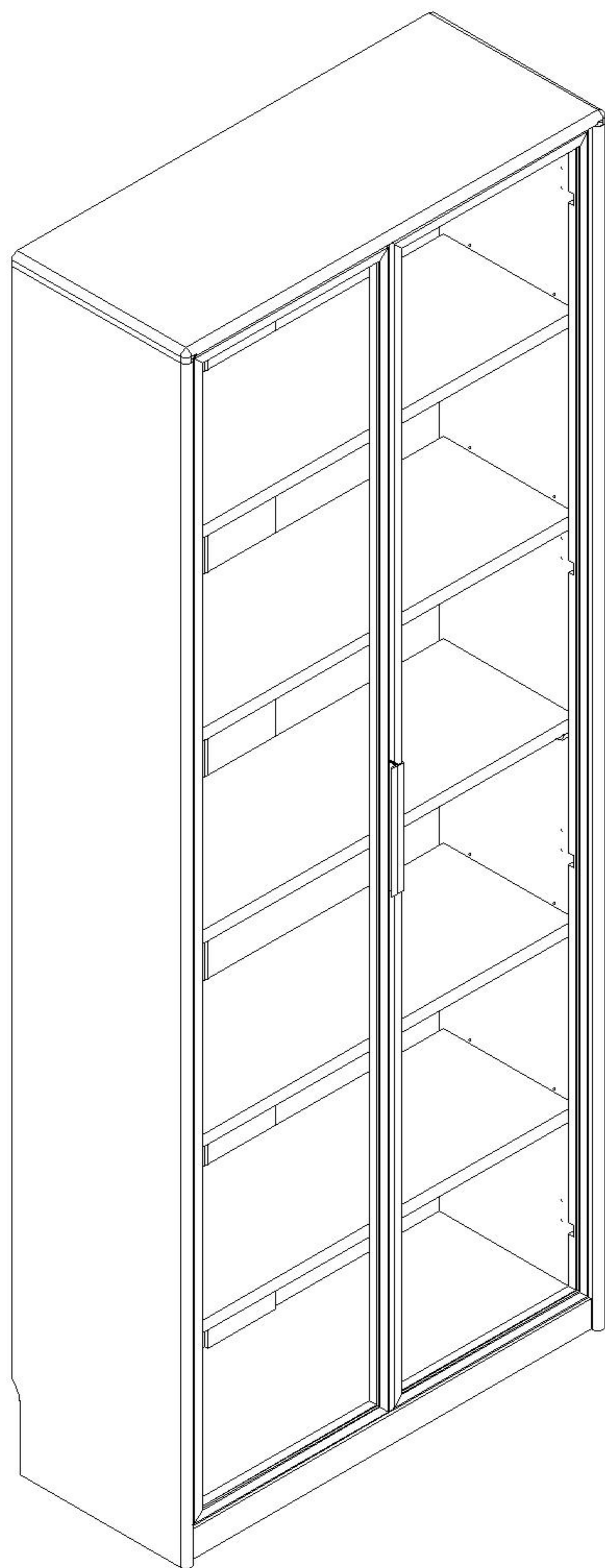

铝合金门框内自带五金

Aluminum alloy door frame with hardware

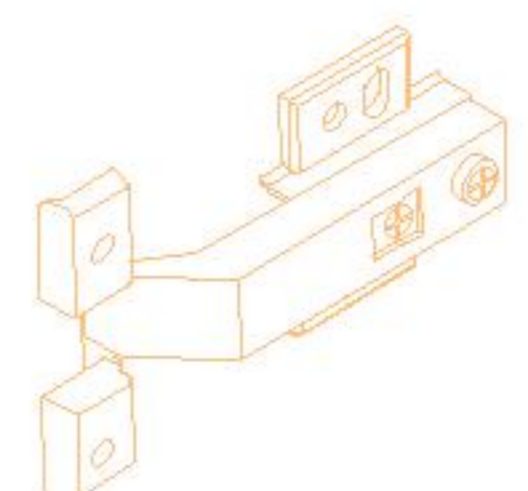
 (M)*8 大弯铝框门铰 Large bend aluminum frame door hinge
--

PK1X-C(0.8m)

安装方法 Installation method

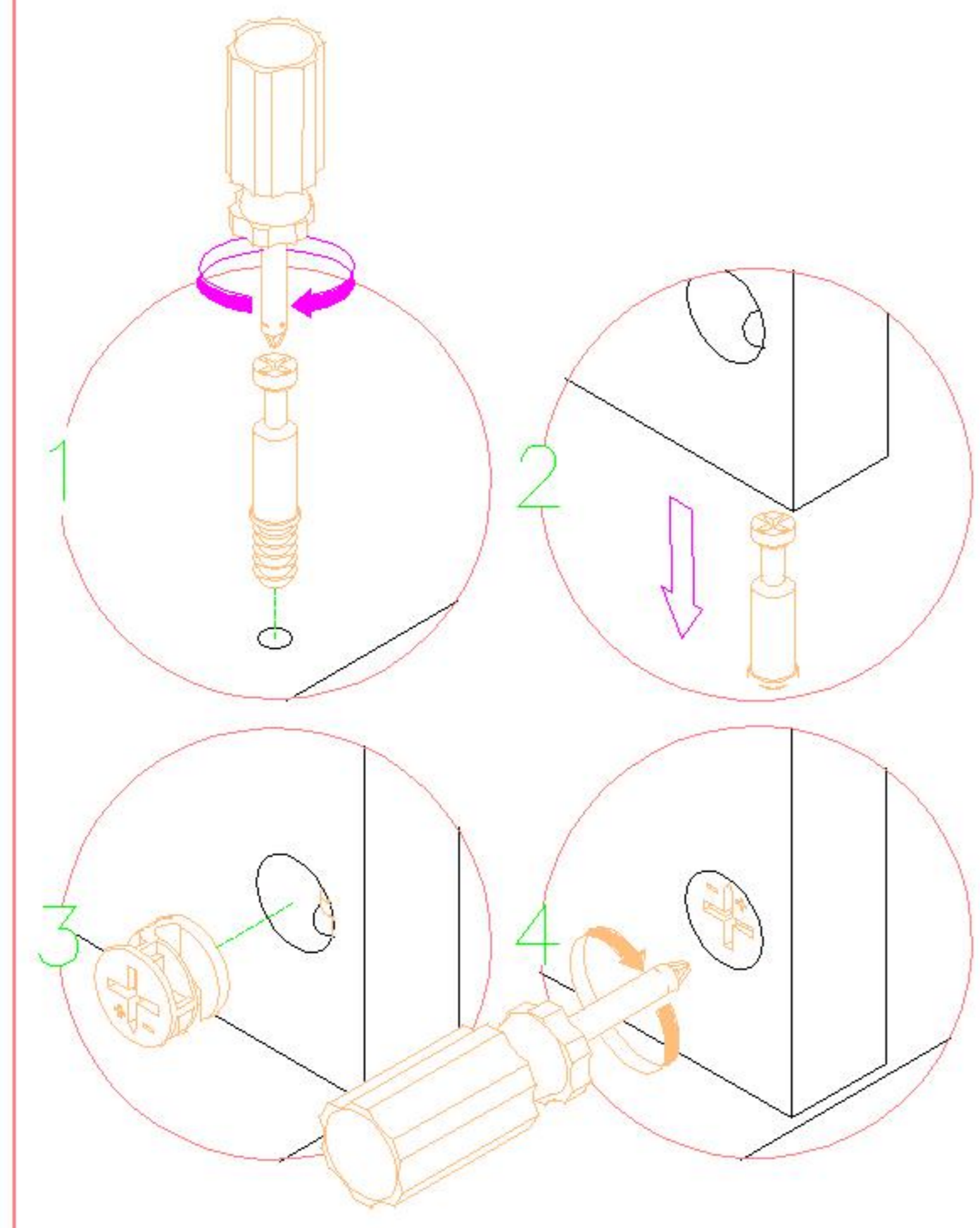

大二合一 two-in-one

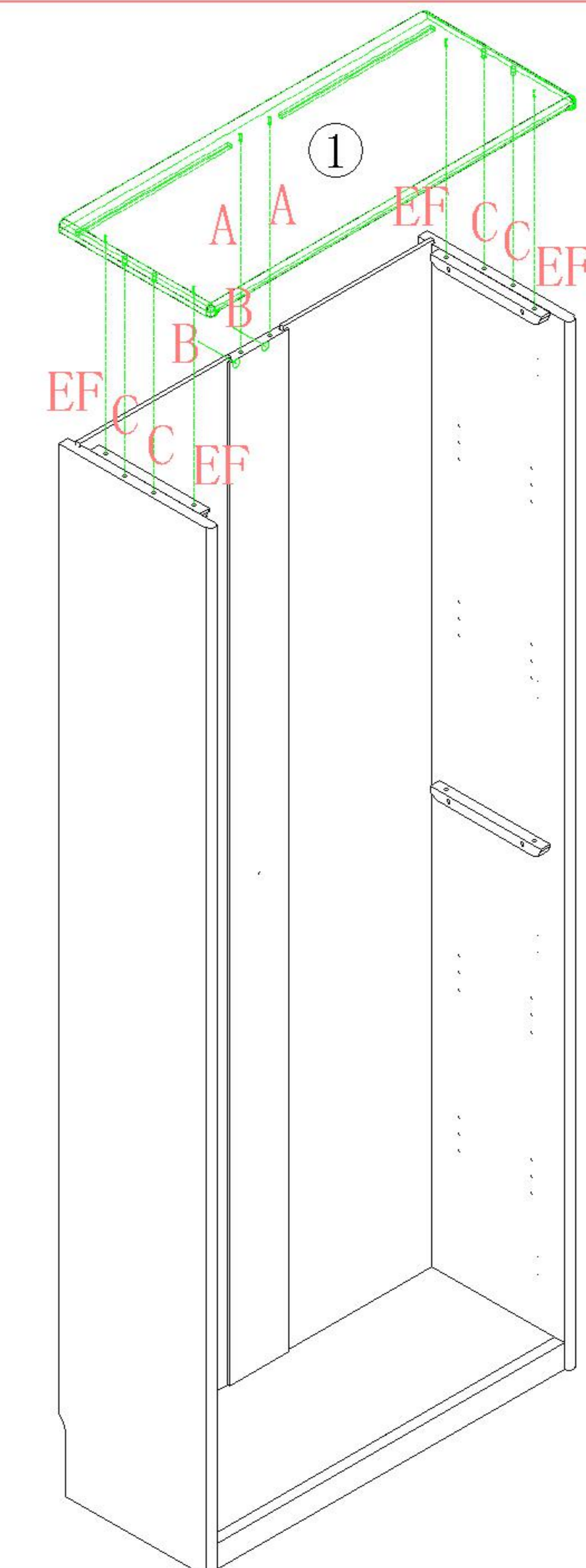
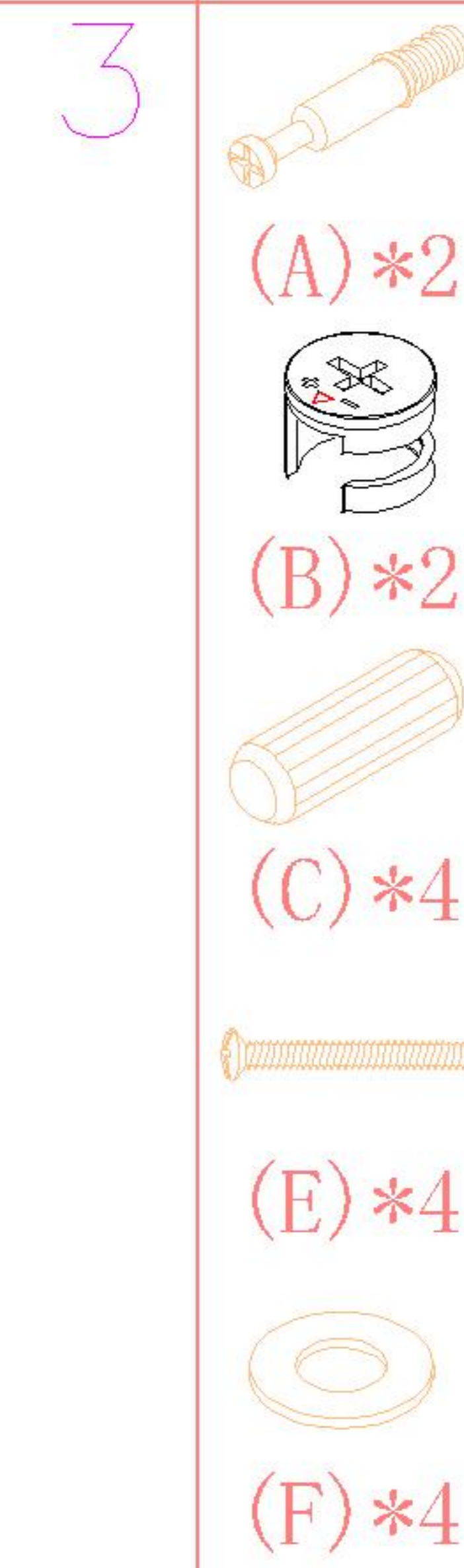
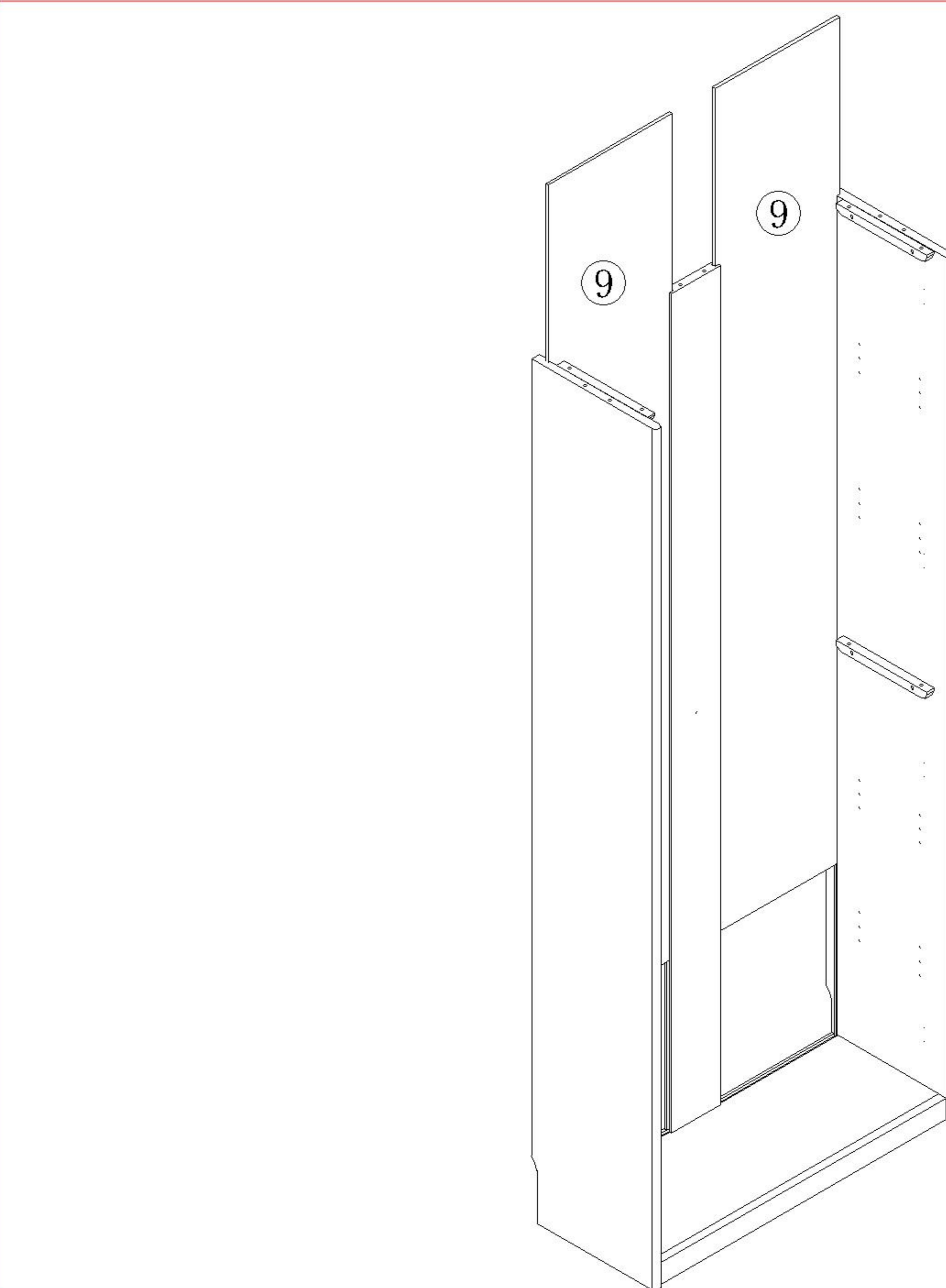
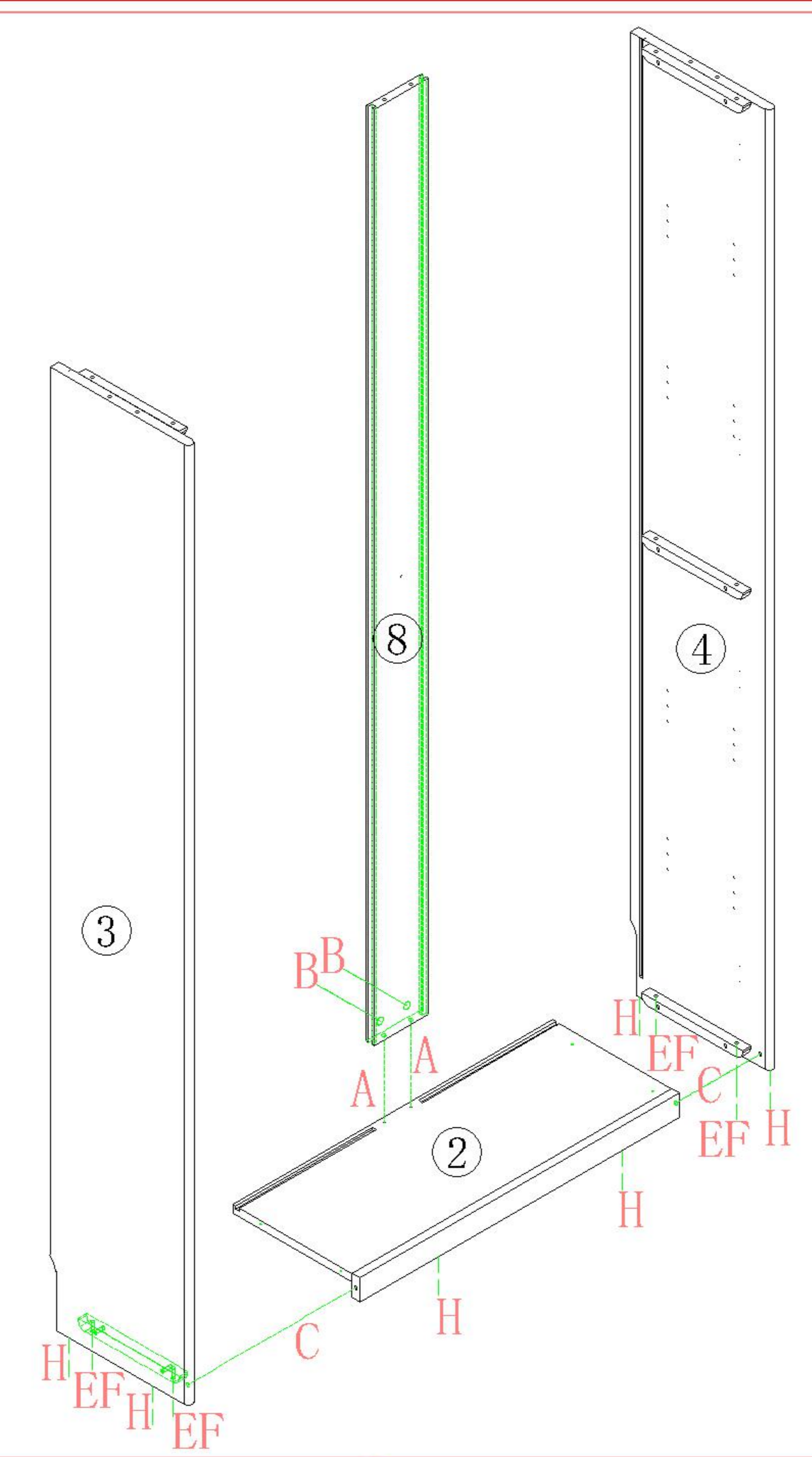
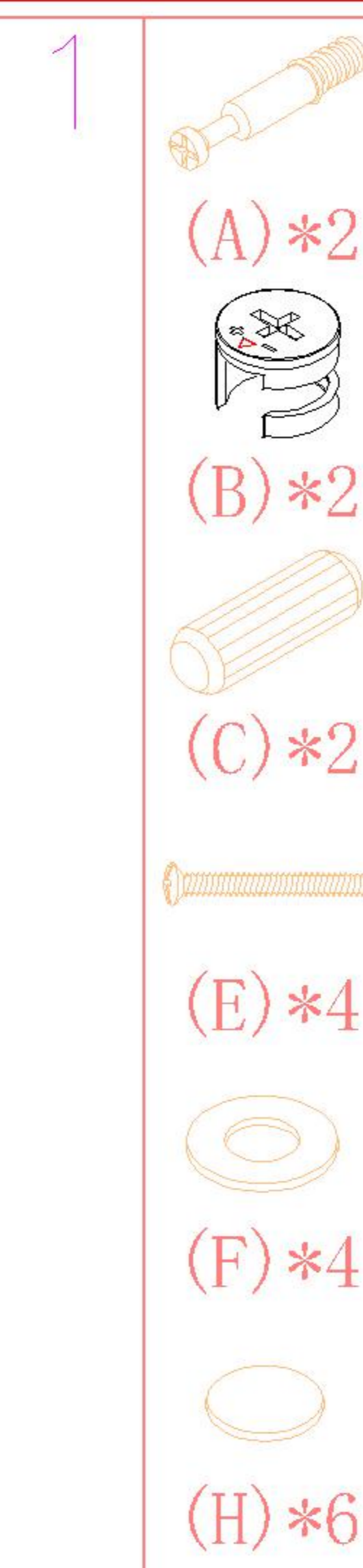
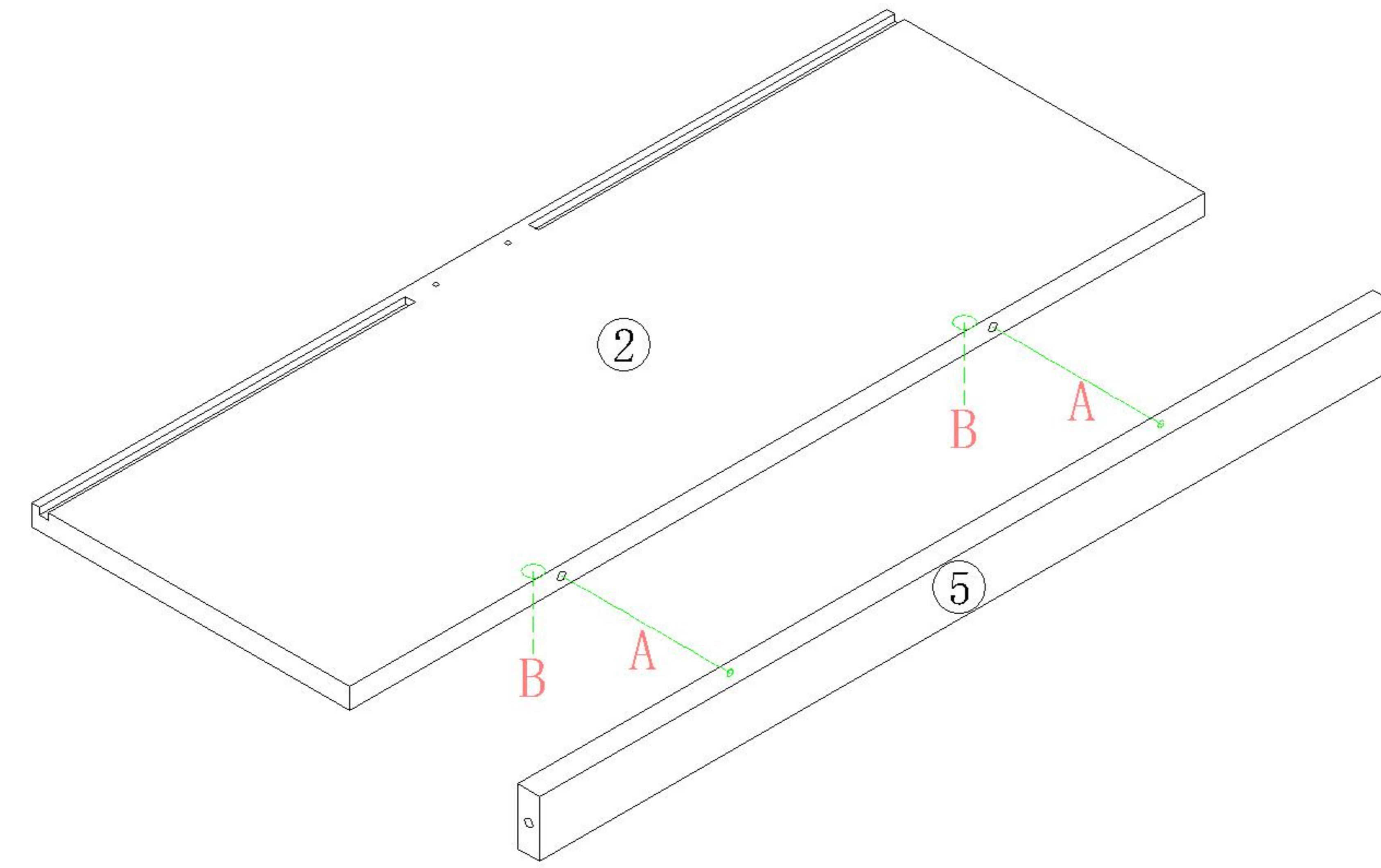
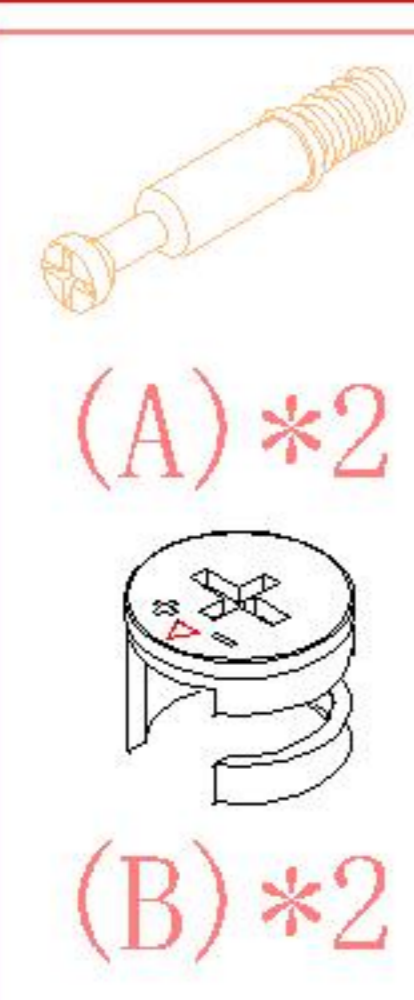

PK1X-C(0.8m)

安装方法

Installation method

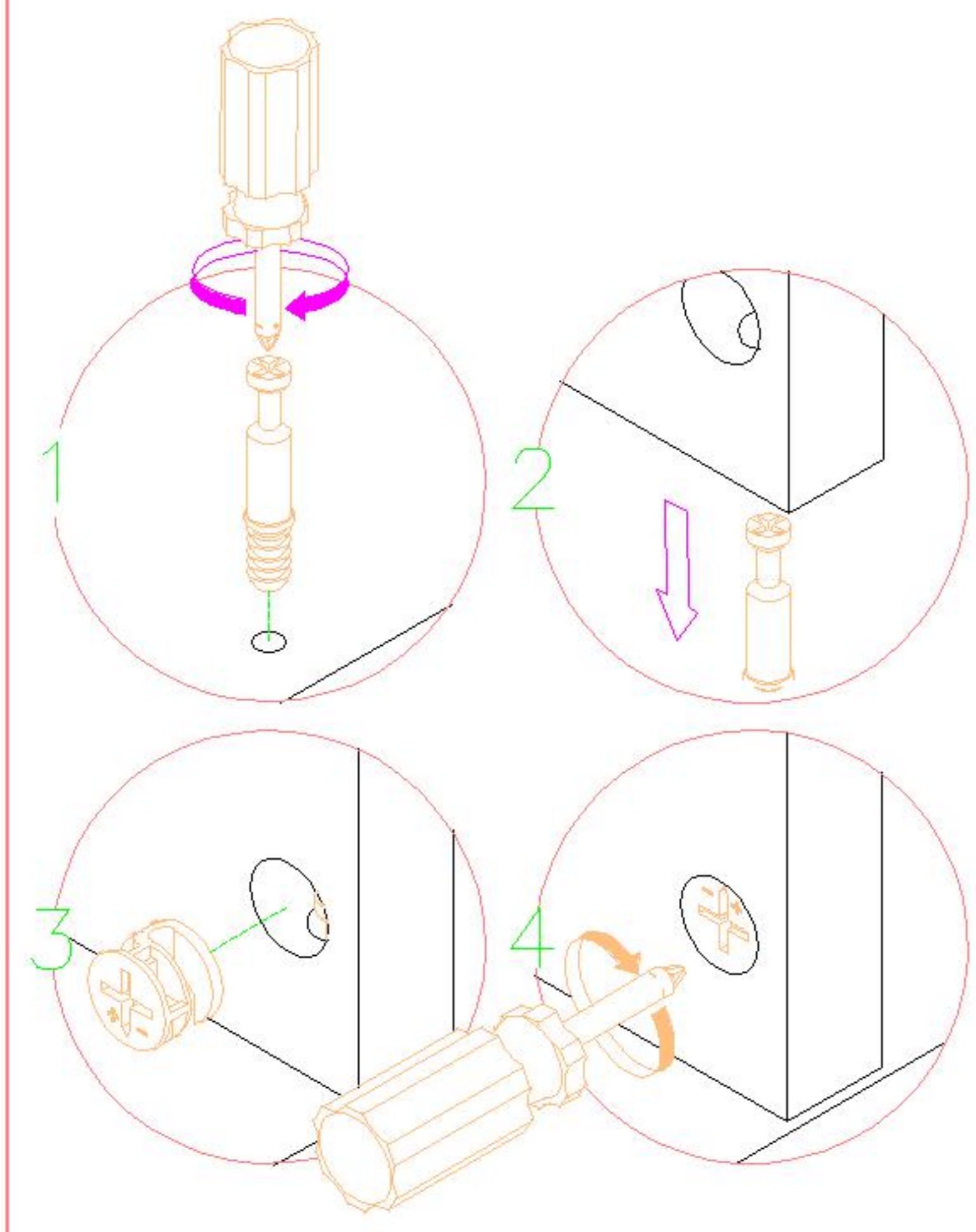

大二合一 two-in-one

大弯big bend

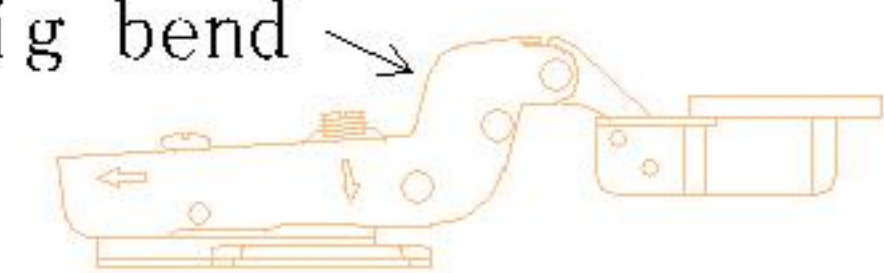

中弯middle bending

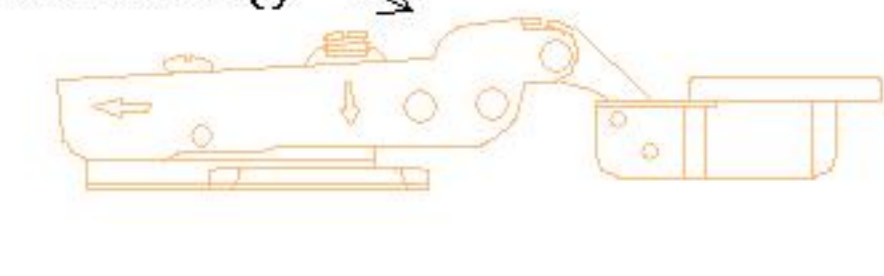

直弯straight bending

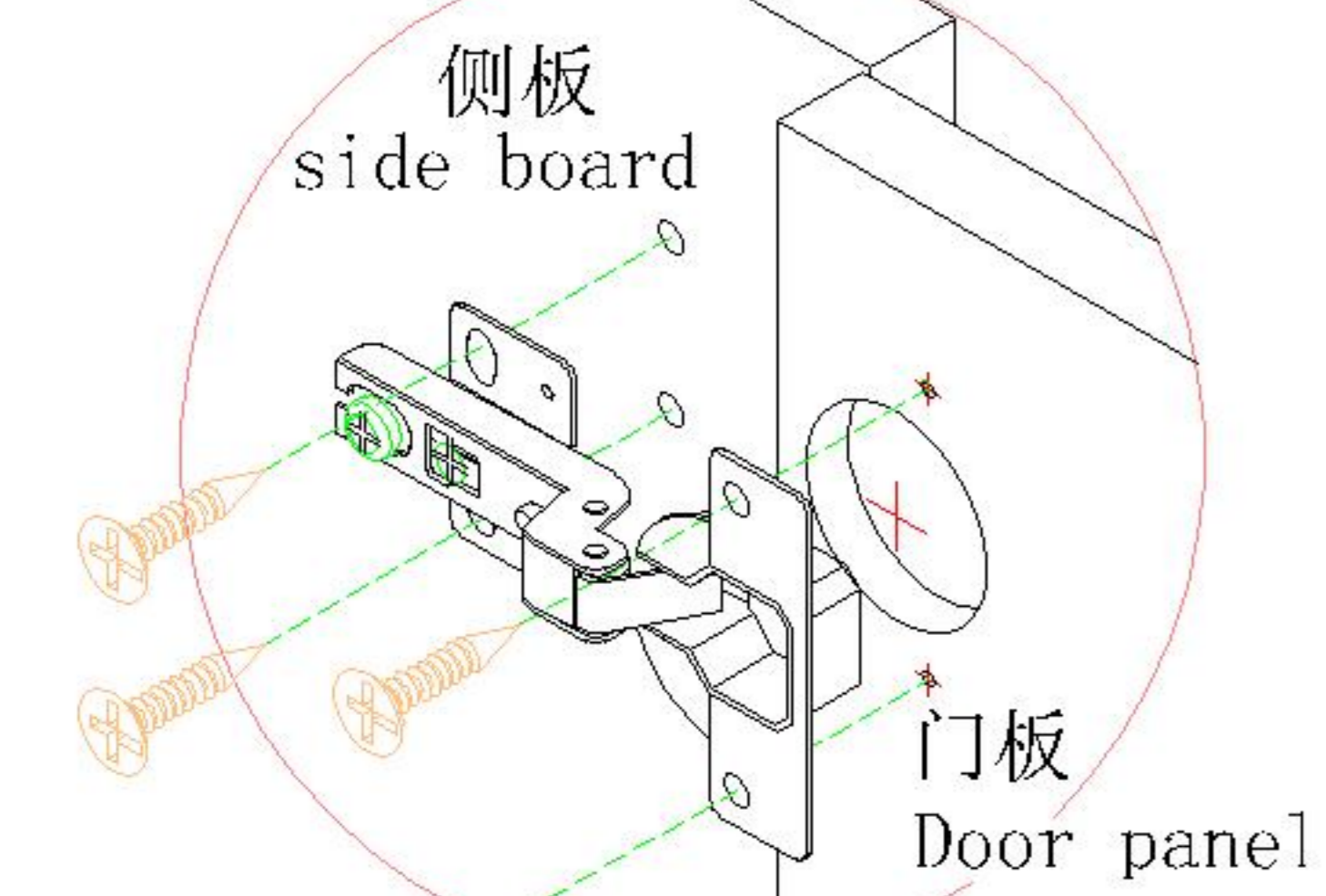
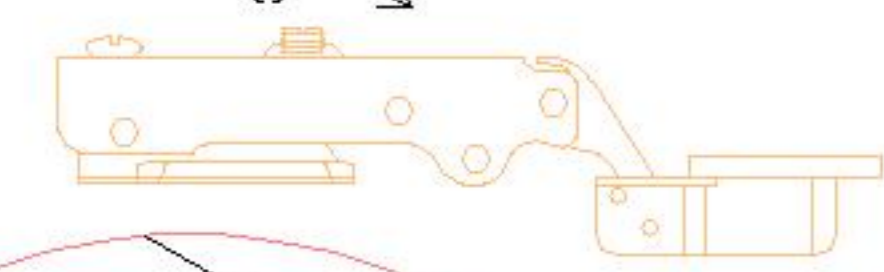

调节上下
Adjust up and down

调节左右
Adjust left and right

调节前后
Before and after adjustment

门铰Hinge



(D)*16



(E)*4



(F)*4

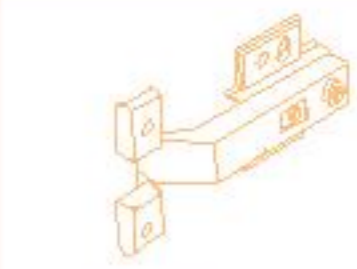

(M)*8

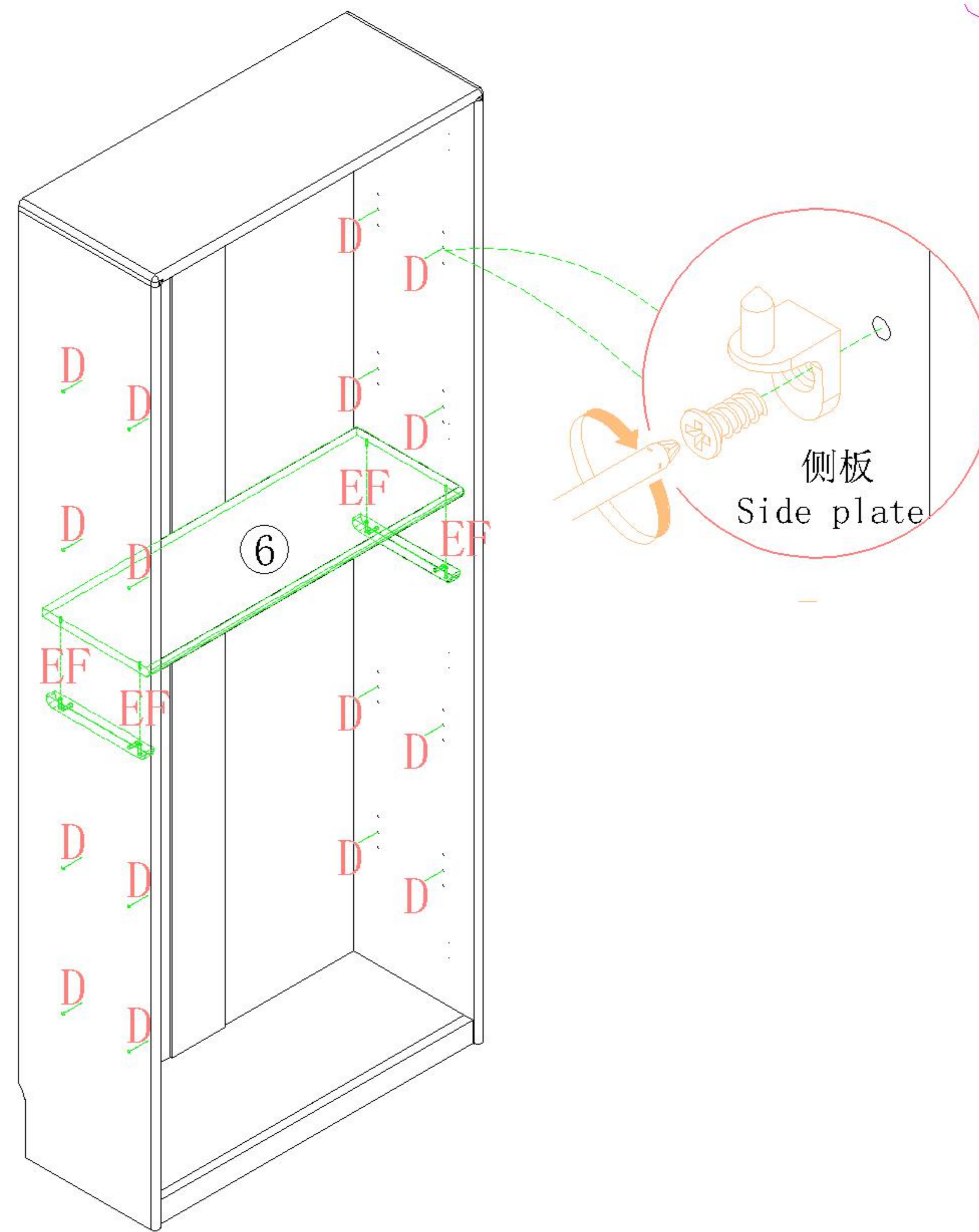

5

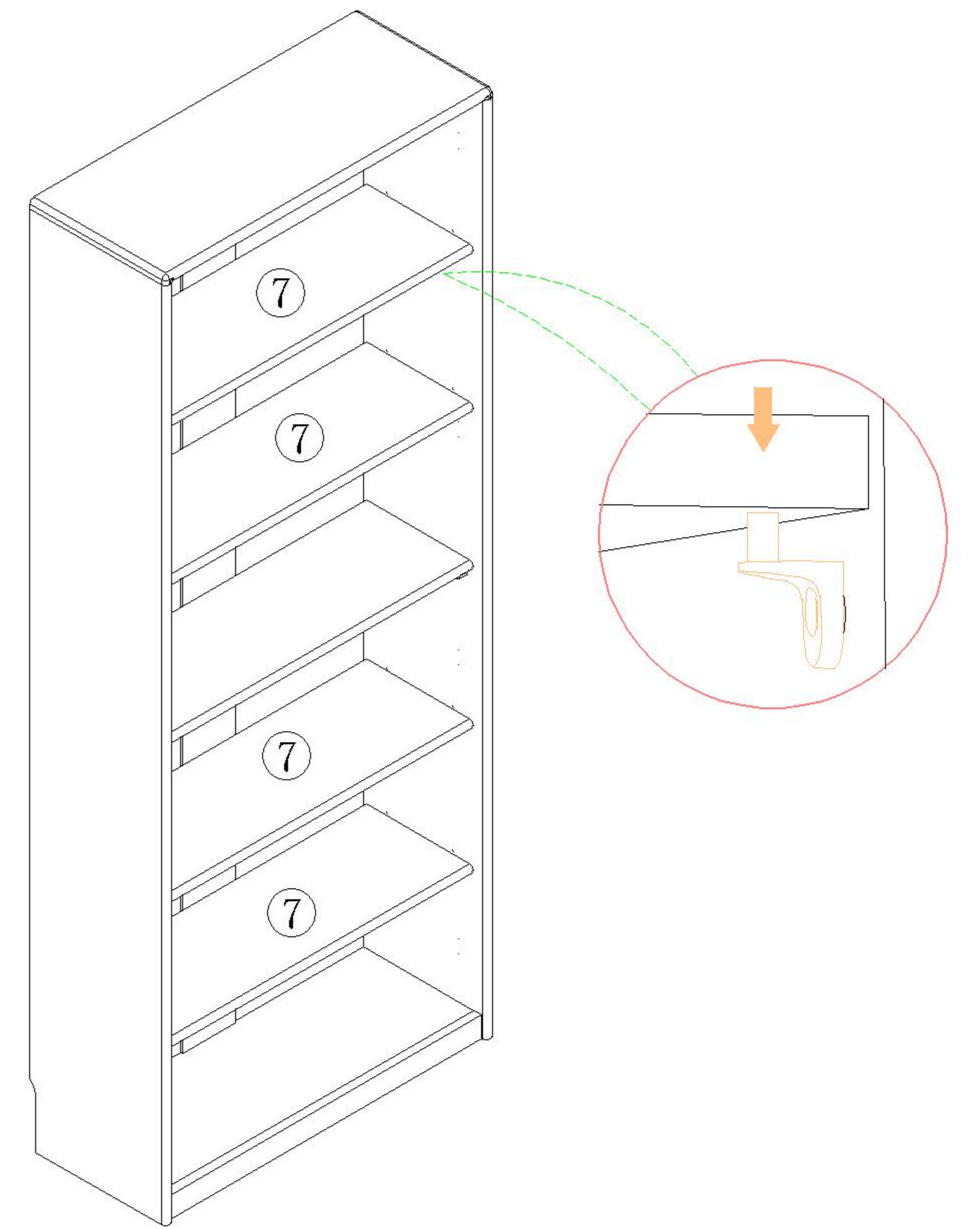

6

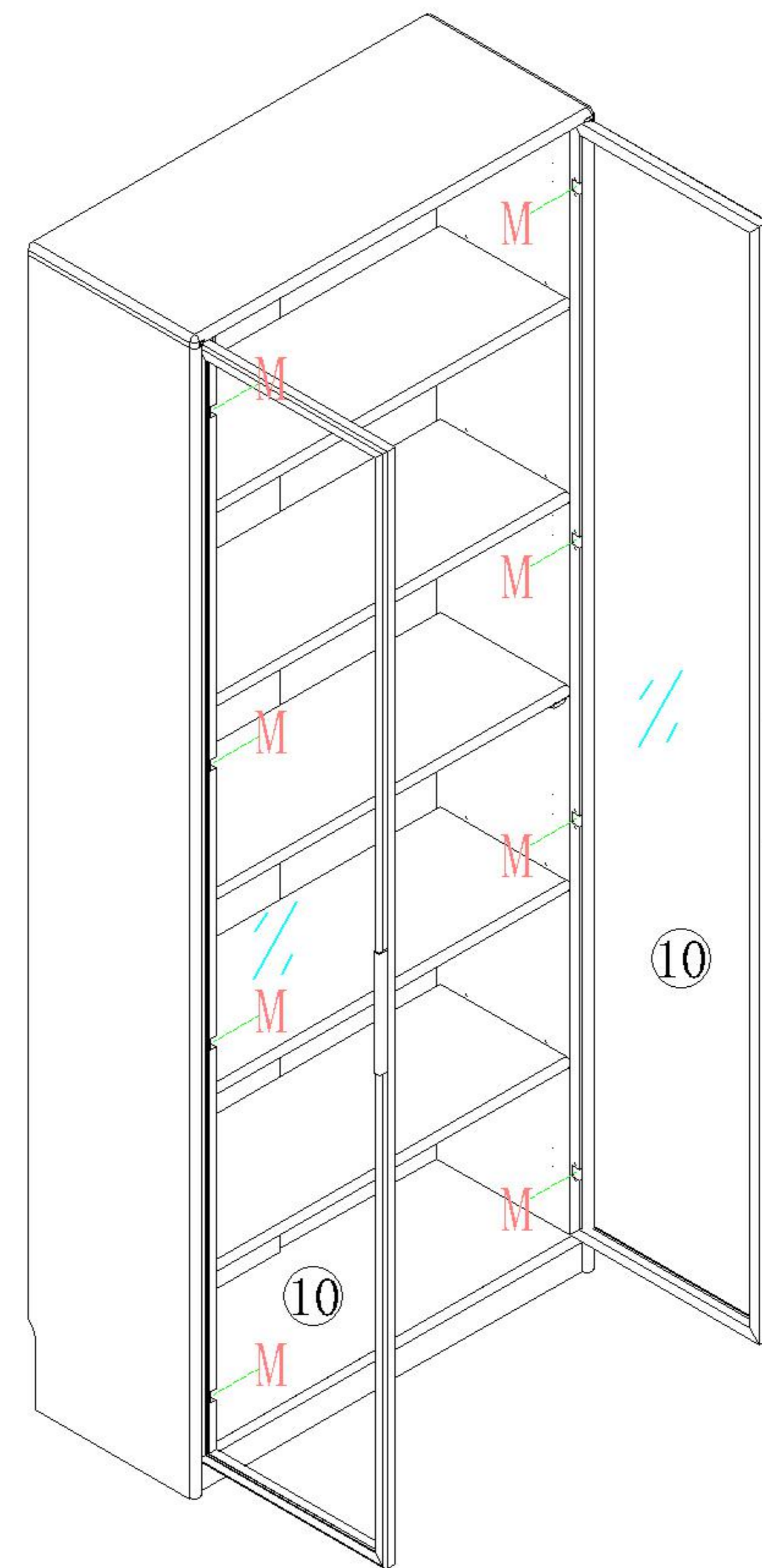

7



(I)*12

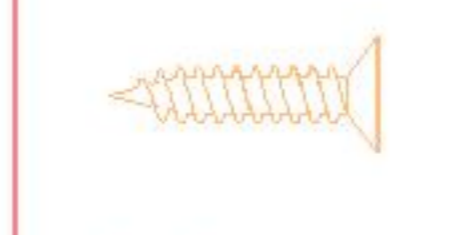

(J)*12



(E)*1

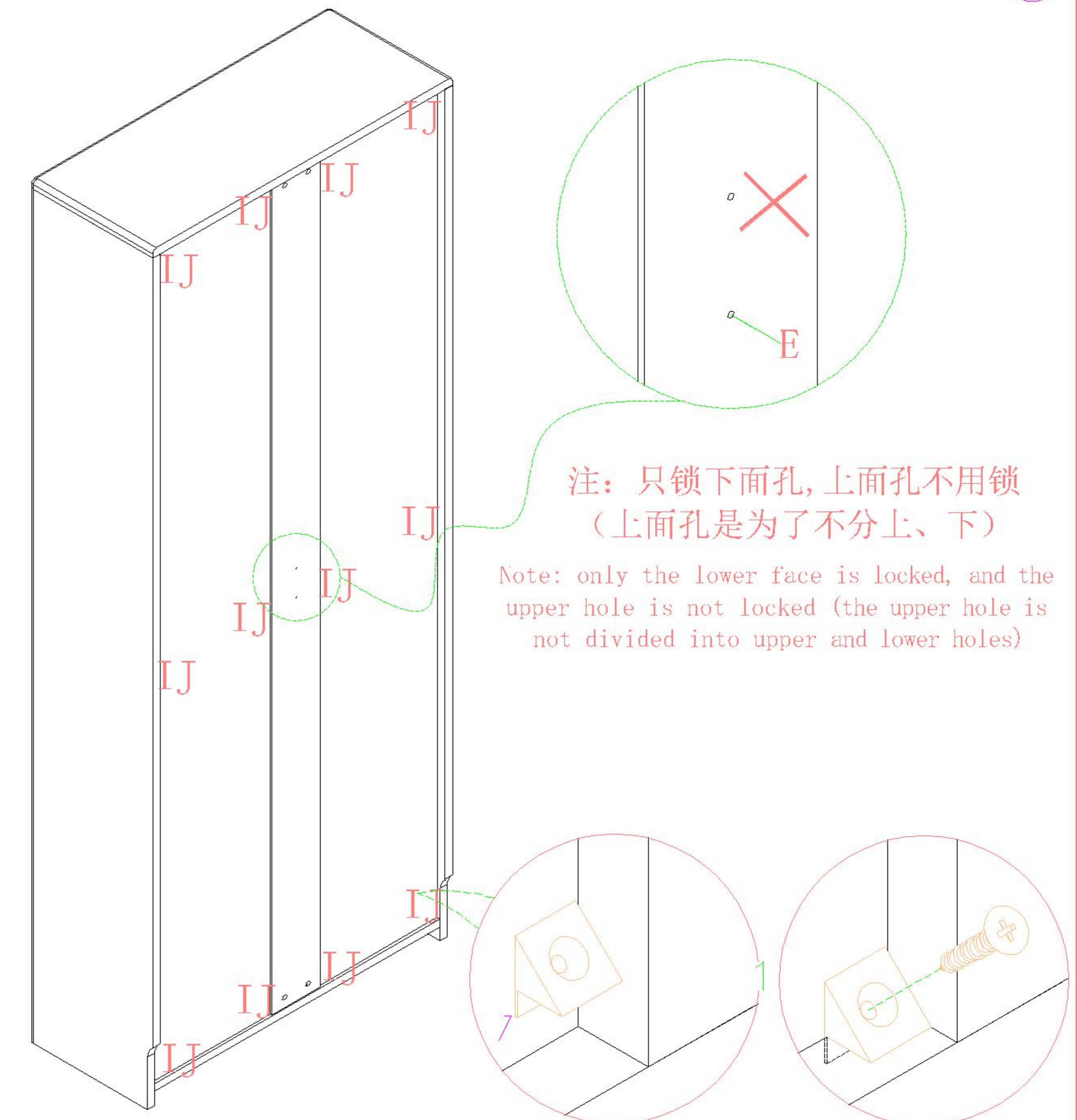

注：只锁下面孔,上面孔不用锁
(上面孔是为了不分上、下)

Note: only the lower face is locked, and the upper hole is not locked (the upper hole is not divided into upper and lower holes)

8

安装方法
Installation method

(G)*2

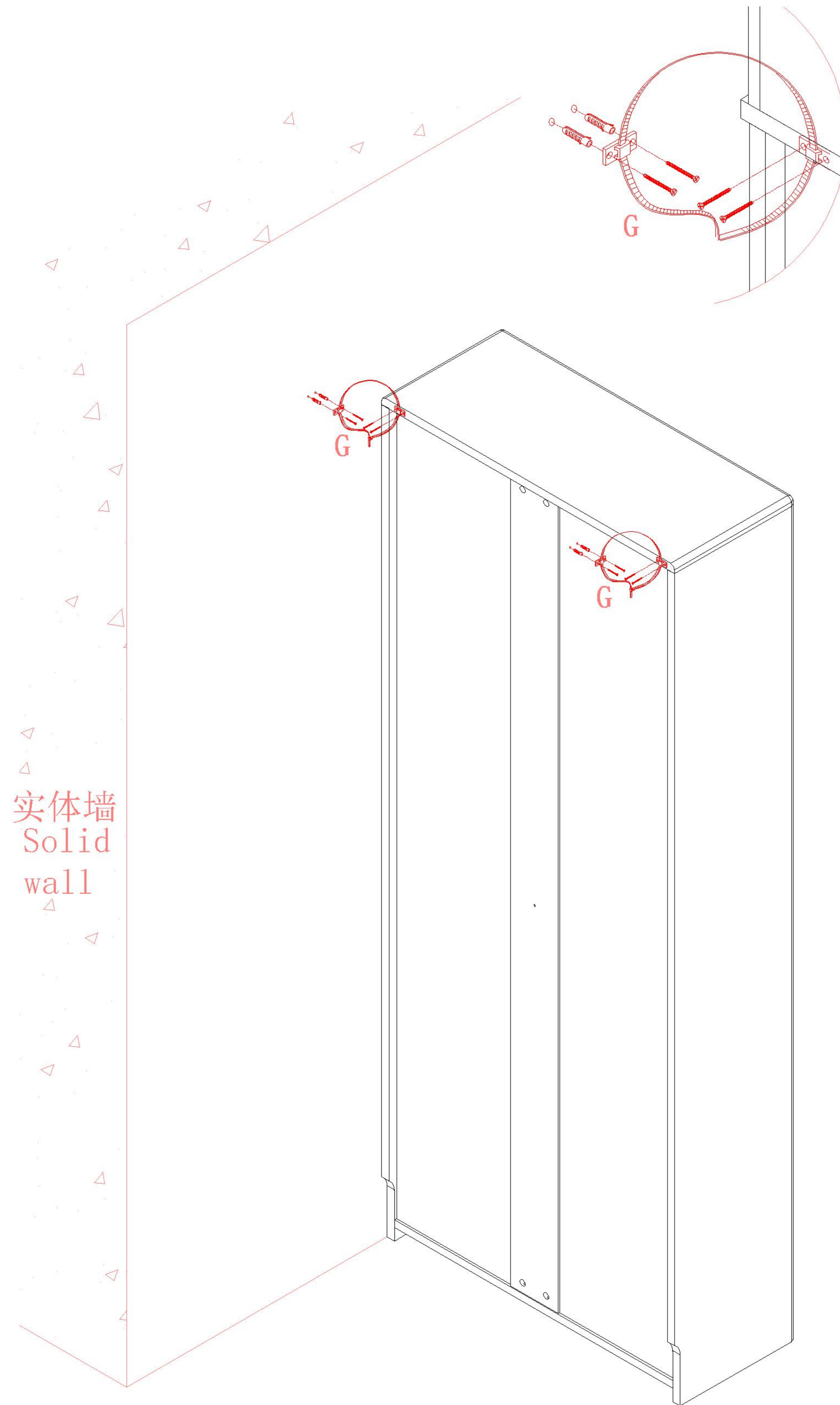

实体墙
Solid
wall

