

组装说明书

产品型号：西雅图B沙发（单人位）

成品图：

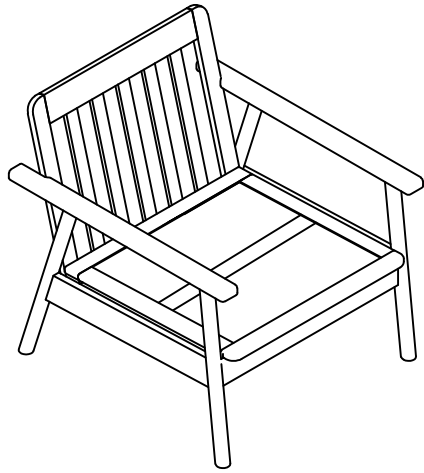

第一步：

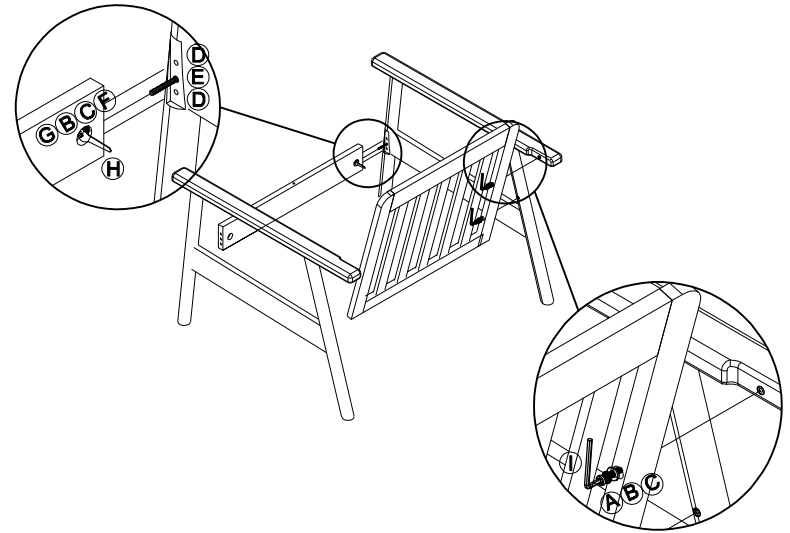



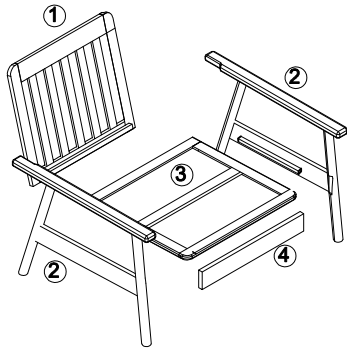



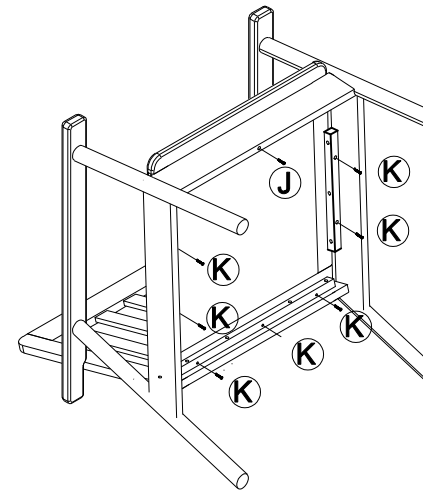



爆炸图：



第二步：



五金清单：

A 	B 	C 	D 	E 	F 
内六角螺杆M8 x 4	M8 弹垫 X 6	M8 垫片 X 6	木棒 $\phi 10 \times 30$ X 2	全丝螺杆M8*80 X2	半月牙 X2
G 	H 	I 	J 	K 	
螺母 X2	扳手 X1	内六角 M5 X1	自攻丝M4*50 X 1	M4*30自攻丝 X 7	