

# 组装说明书

产品型号：西雅图B沙发（单人位）

成品图：

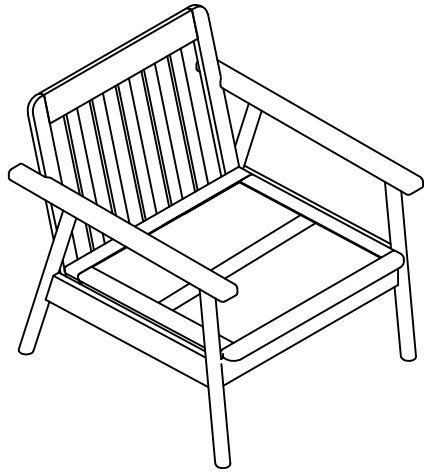

第一步：

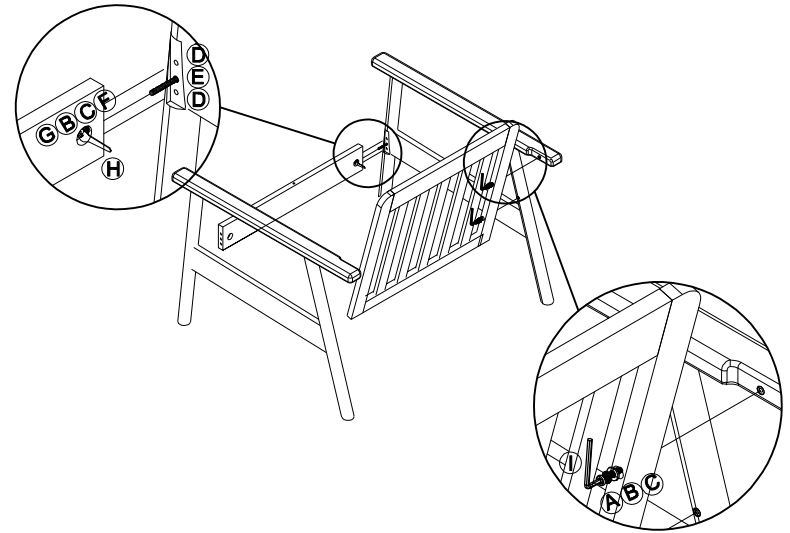



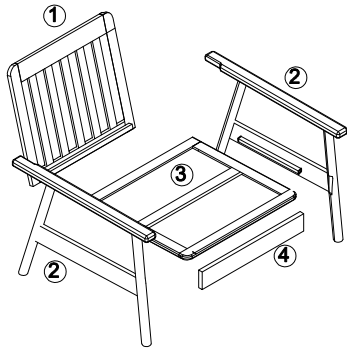



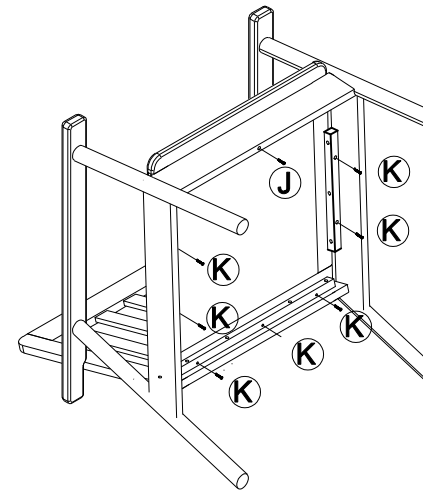



爆炸图：



第二步：



五金清单：

<b>A</b> 	<b>B</b> 	<b>C</b> 	<b>D</b> 	<b>E</b> 	<b>F</b> 
内六角螺杆M8×4	M8弹垫 X 6	M8垫片 X 6	木棒φ10×30 X 2	全丝螺杆M8×80 X2	半月牙 X2
<b>G</b> 	<b>H</b> 	<b>I</b> 	<b>J</b> 	<b>K</b> 	
螺母 X2	扳手 X1	内六角 M5 X1	自攻丝M4*50 X 1	M4*30自攻丝 X 7	