

组装说明书

产品型号：西雅图B沙发（三人位）

成品图：

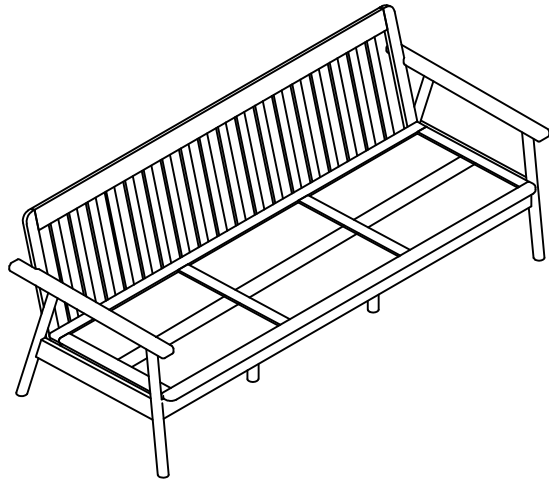



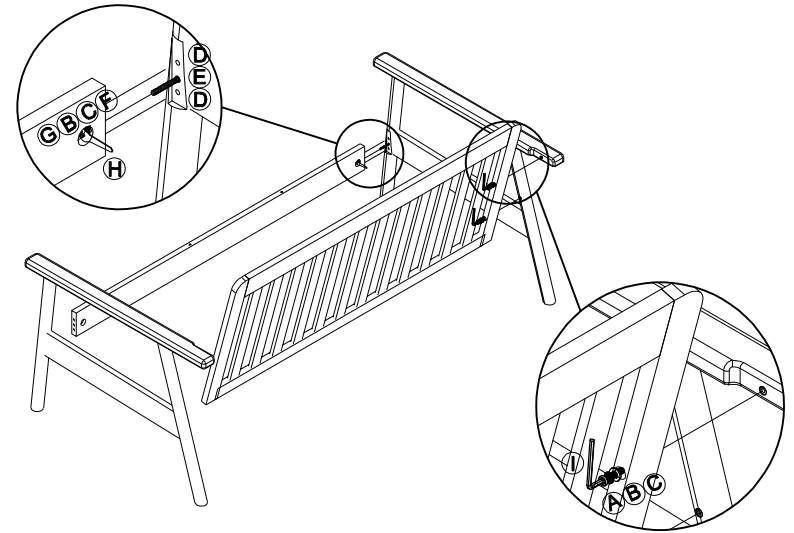



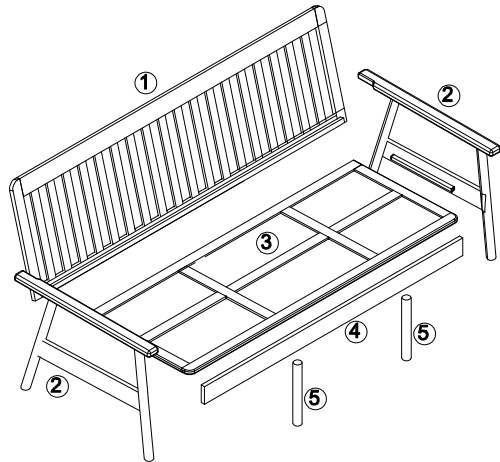



第一步：



爆炸图：



五金清单：

A 	B 	C 	D 	E 	F 
内六角螺钉M8 X 4	M8 弹垫 X 6	M8 垫片 X 6	木棒 $\phi 10 \times 30$ X 2	全丝螺杆M8*80 X 2	半月牙 X 2
G 	H 	I 	J 	K 	
螺母 X 2	扳手 X 1	内六角 M5 X 1	自攻丝M4*50 X 2	M4*30自攻丝 X 8	

第二步：

