

Boori

Seagull



Cot

辛格婴儿床

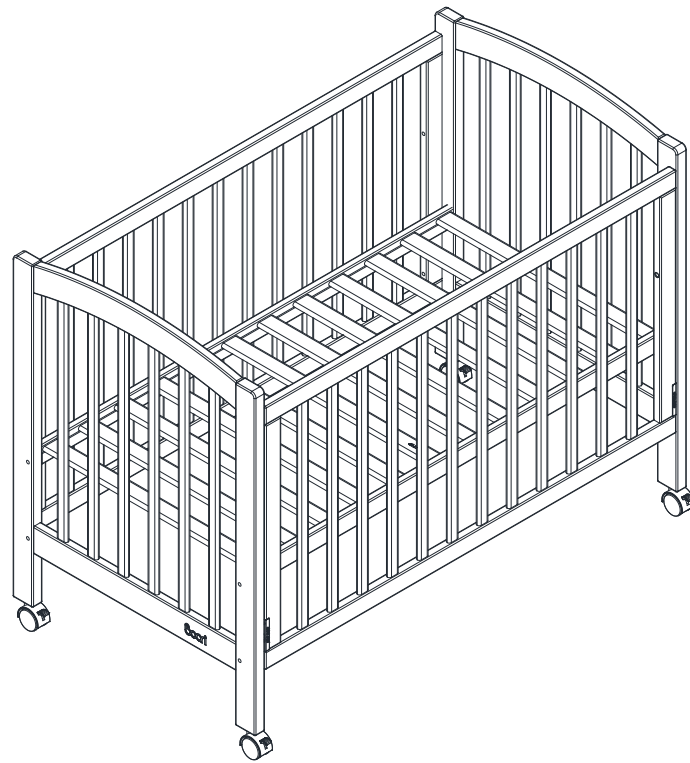

**IMPORTANT:
PLEASE READ THE INSTRUCTIONS CAREFULLY
AND KEEP FOR FUTURE REFERENCE**

重要：请仔细阅读此说明书，并妥善保管以便日后参考。

B-SECOD

Boori Australia Pty Ltd
 11/4 Southridge Street
 Eastern Creek NSW 2766
 Tel: +61 2 9833 3769
 www.boori.com.au

Boori (Europe) Ltd
 Unit 1 Riverside House,
 Mill Lane, Newbury,
 Berkshire, RG14 5QS UK
 Tel: +44 016 3529 5670
 www.boori.co.uk

ブーリジャパン株式会社
 〒141-0022
 東京都品川区東五反田
 1-10-9 STビル8F
 TEL: 03-6420-0024
 EMAIL: info@boori.co.jp
 HP: www.boori.jp

浙江瀚豪实业有限公司
 浙江省嘉兴市南湖区七星街道
 都市经济产业园（东大路西）
 电话：0573-83885718
 网址：www.boori.com
 邮编：314002

Seagull Cot(B-SECOD)



Dimensions(External / 外径): 1258*705*961(mm)

Main Materials: Australia Araucaria、LVL

产品规格 (Internal / 内径): 1200*659(mm)

主要材质: 澳洲南洋杉、实木多层板 (LVL)

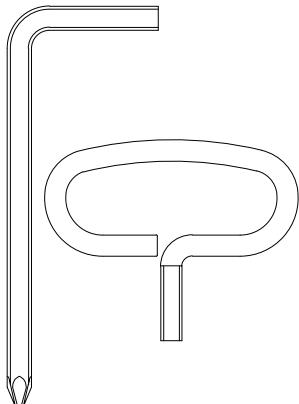
Hardware/五金单

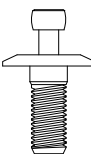
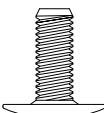
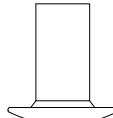
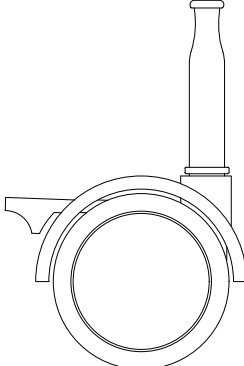
A x 2	B x 8	C x 4	D x 8	E x 4	F x 4
					
	M6 x 60	M6 x 14	M6 x 18	M6 x 14	

Parts List/部件清单

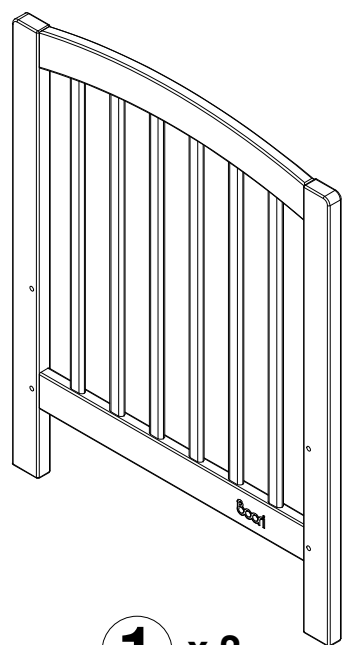

① x 2

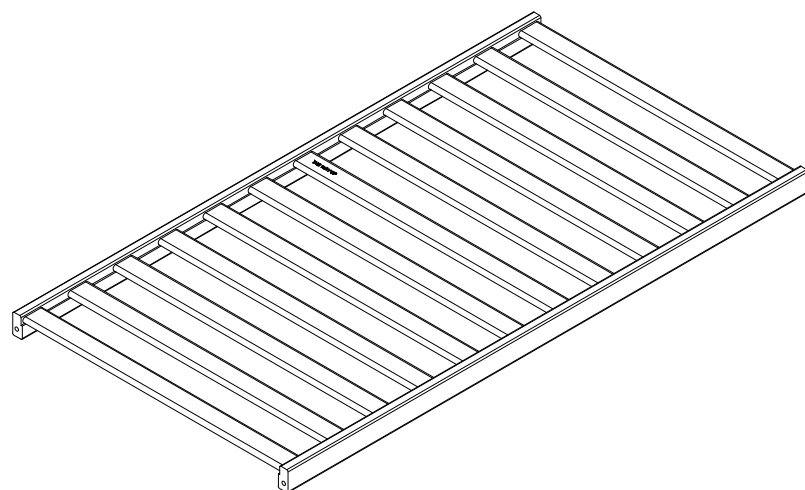

② x 1

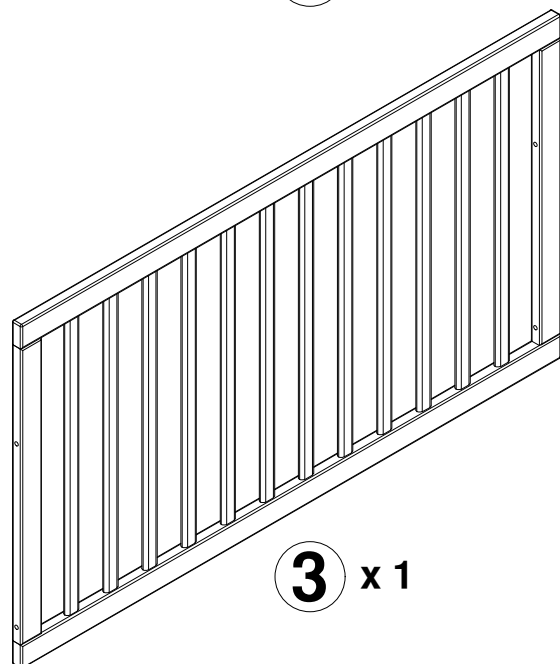

③ x 1

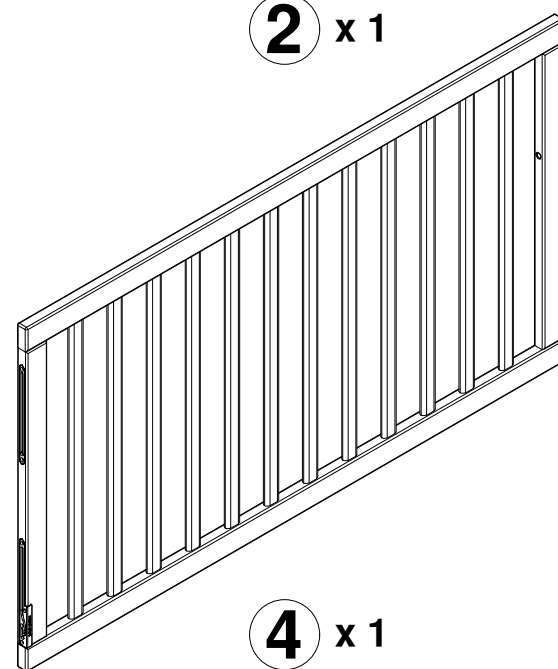

④ x 1

Note: Use only spare parts approved by the manufacturer.

注意: 仅限使用制造商提供的产品零配件及五金。

Assembly / 安装说明

1

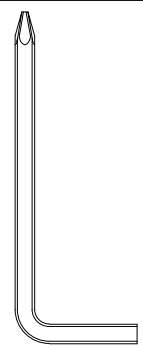
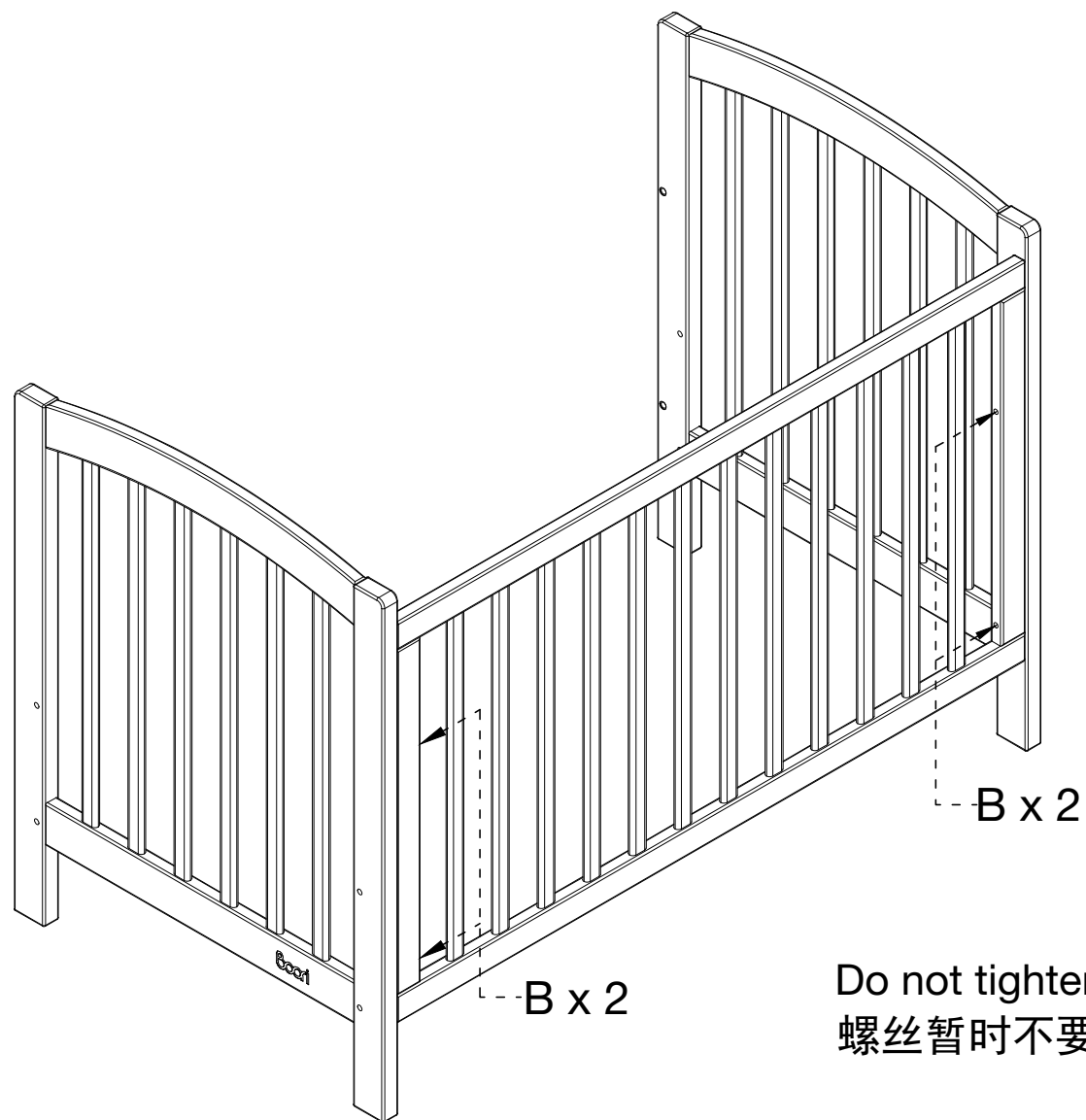

A x 1



B x 4

Do not tighten the bolts for now.
螺丝暂时不要完全锁紧。

2

⚠ Sticker side of the base must face up.
床板印字的标签面朝上。

Top Hole high base
position(for newborn).
高孔位：底板放置高位
(新生儿使用位置)。

B x 4

Bottom Hole low base
position(for baby).
低孔位：底板放置低位
(婴幼儿使用位置)。

⚠ Base should be lowered to this position
before child is able to sit up.
当婴幼儿能坐起时改到床底板低孔位。



B x 4

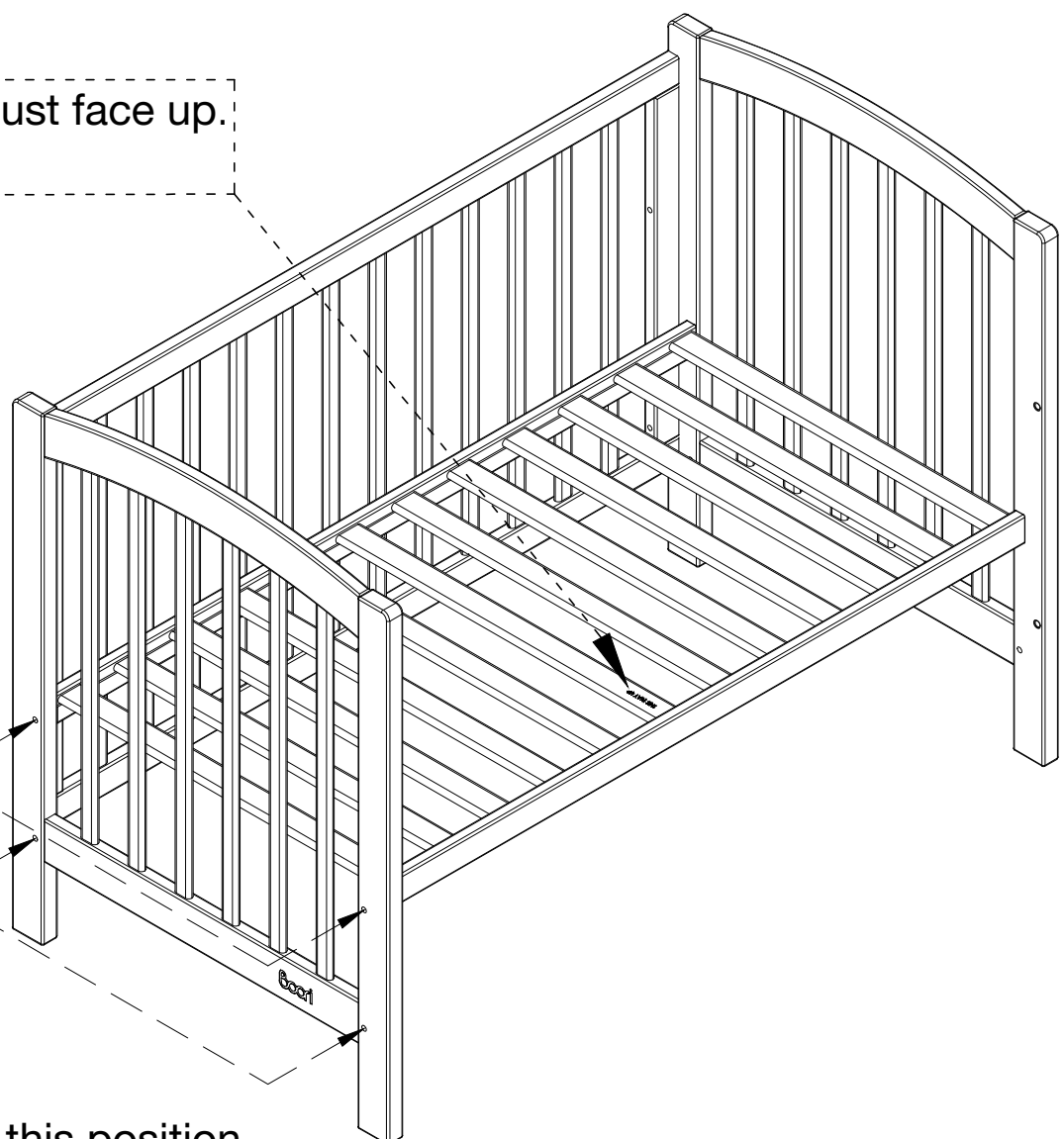

Assembly / 安装说明

3

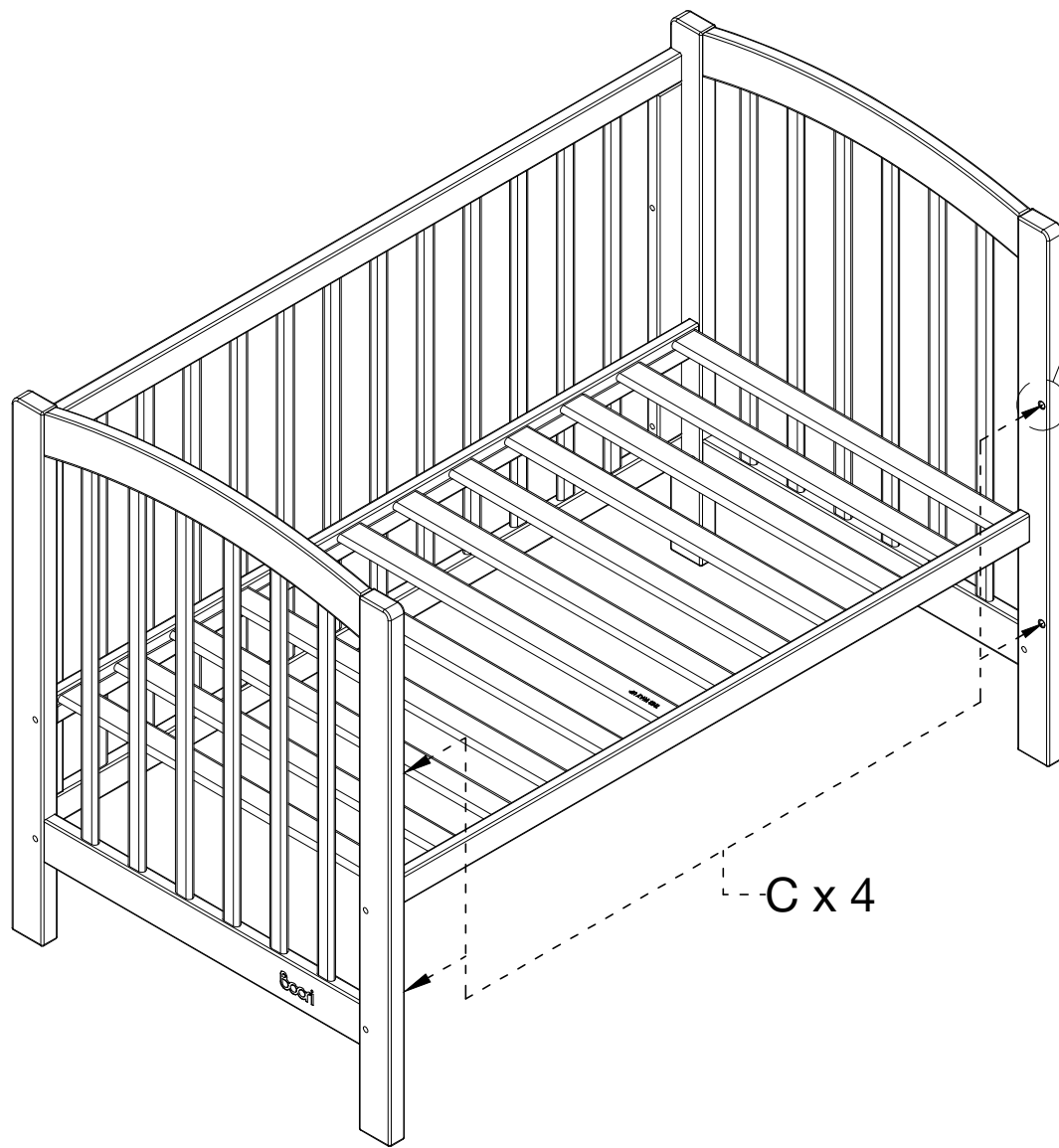

The screws should be locked.
螺丝要锁紧。

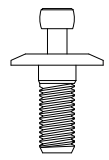

C x 4

4

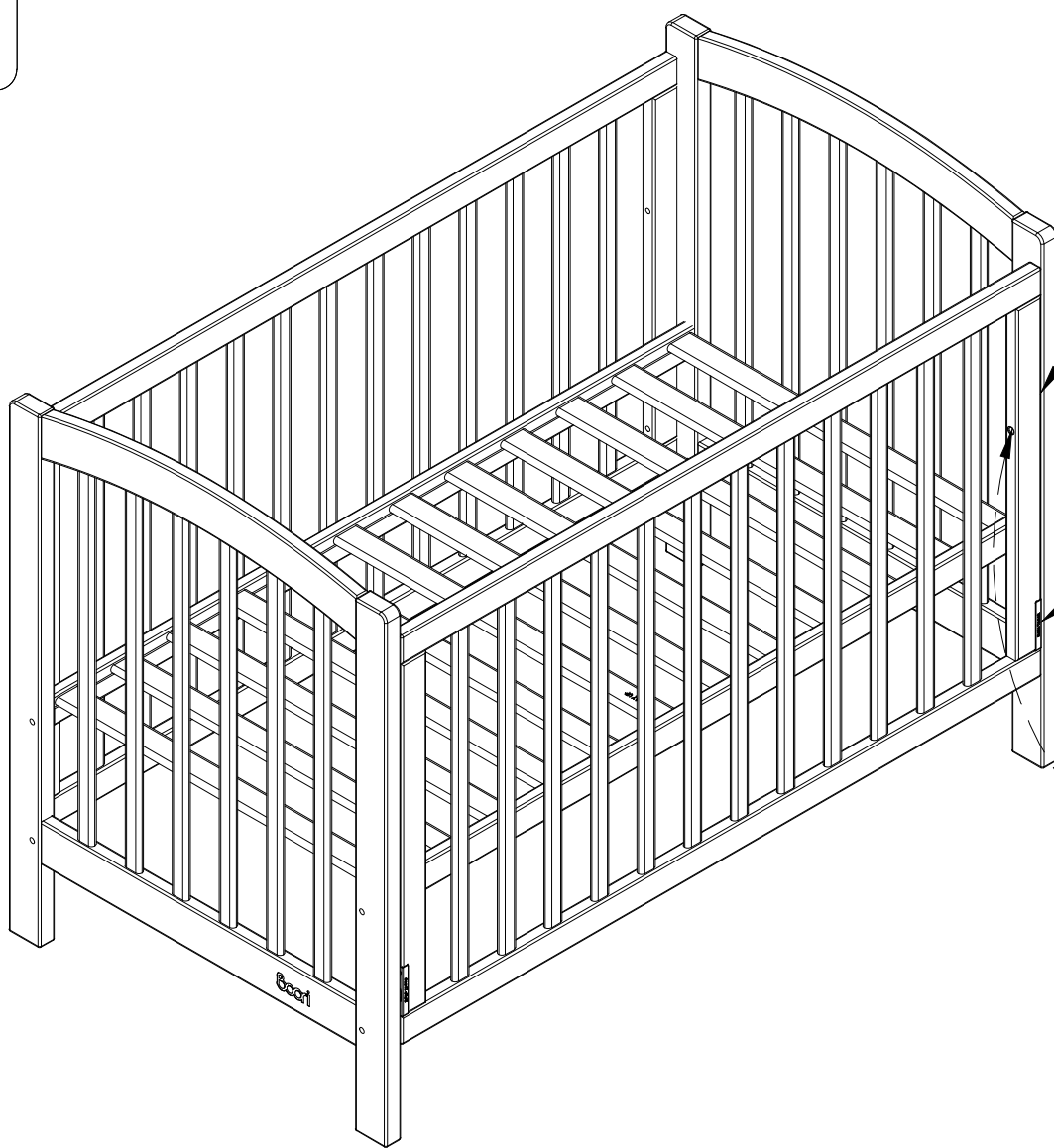

Ensure that correct
side is facing out.
确保此面朝外。

Tighten
锁紧

5

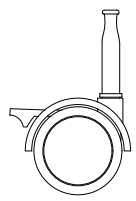
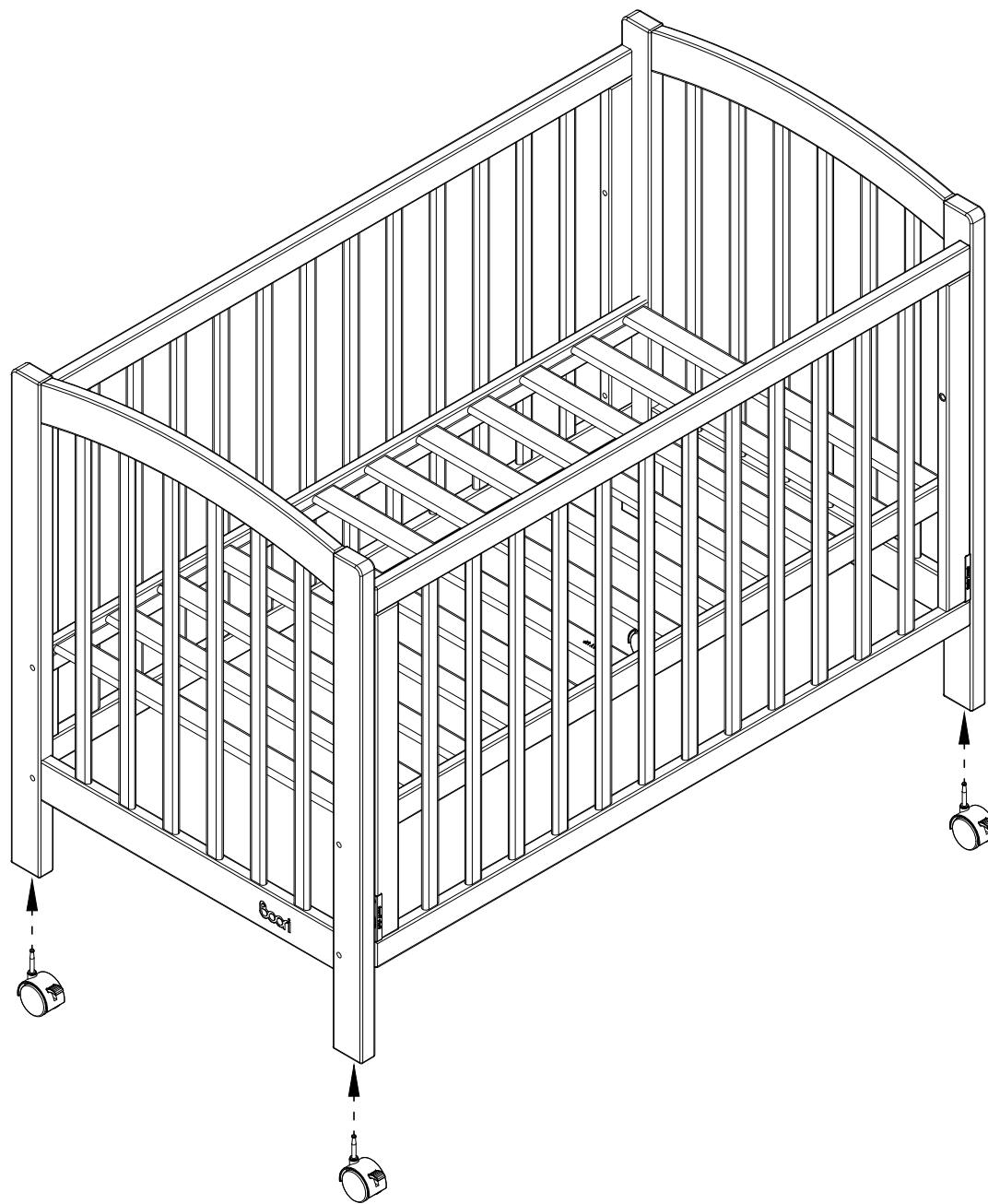

F x 4

6

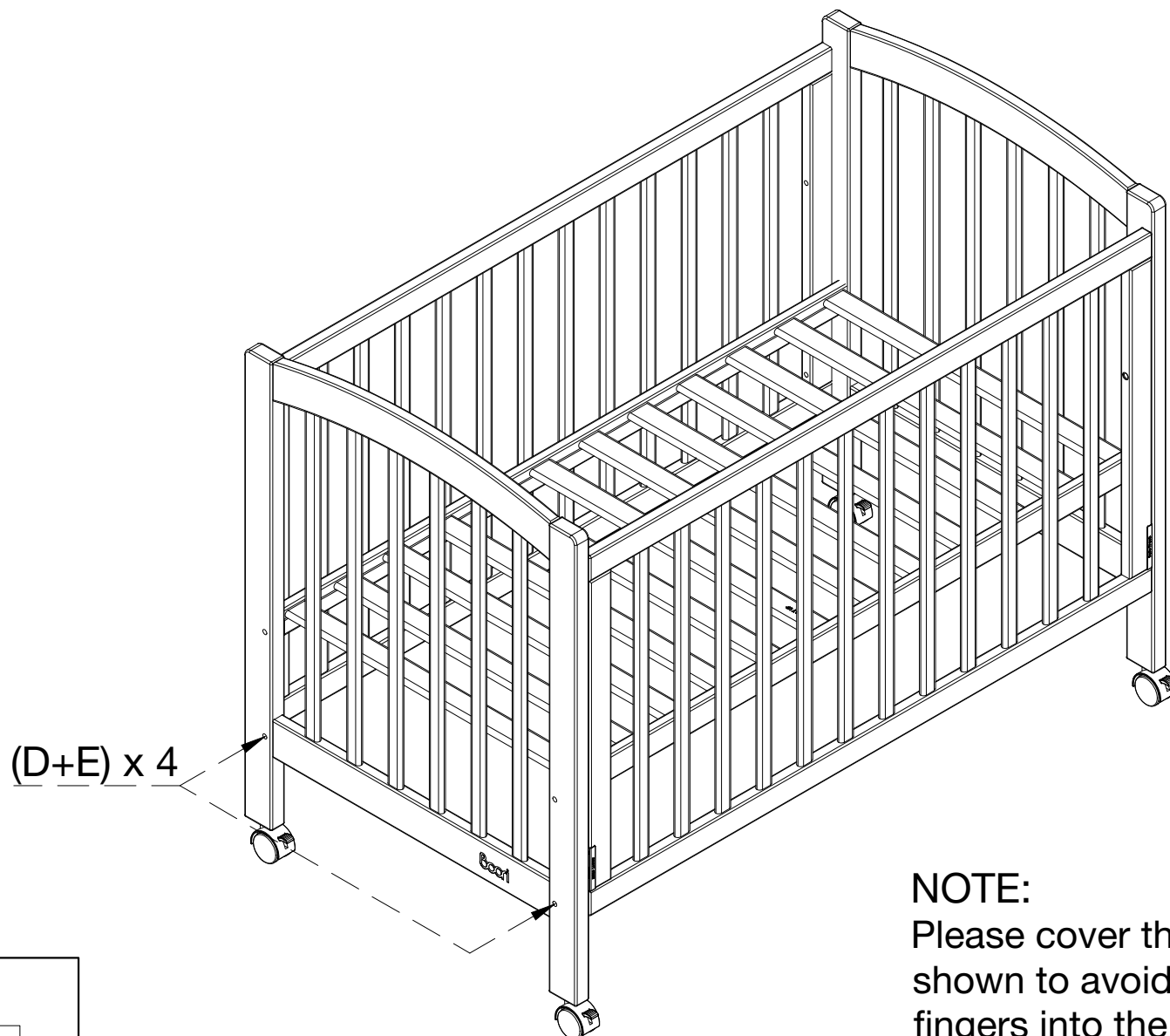

(D+E) x 4

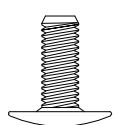

D x 4

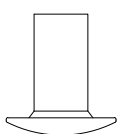

E x 4

NOTE:

Please cover the remaining holes as shown to avoid harm if baby insert their fingers into the hole.

注意：

请按图示把剩余的孔堵上，以免宝宝手指插入孔内造成伤害。

Assembly / 安装说明

7

Lowering the base height.
降低床底板。

Loosen the 4 x B connecting bolts in the Fixed Side Panel.
松开一点固定护栏的4颗螺丝B。

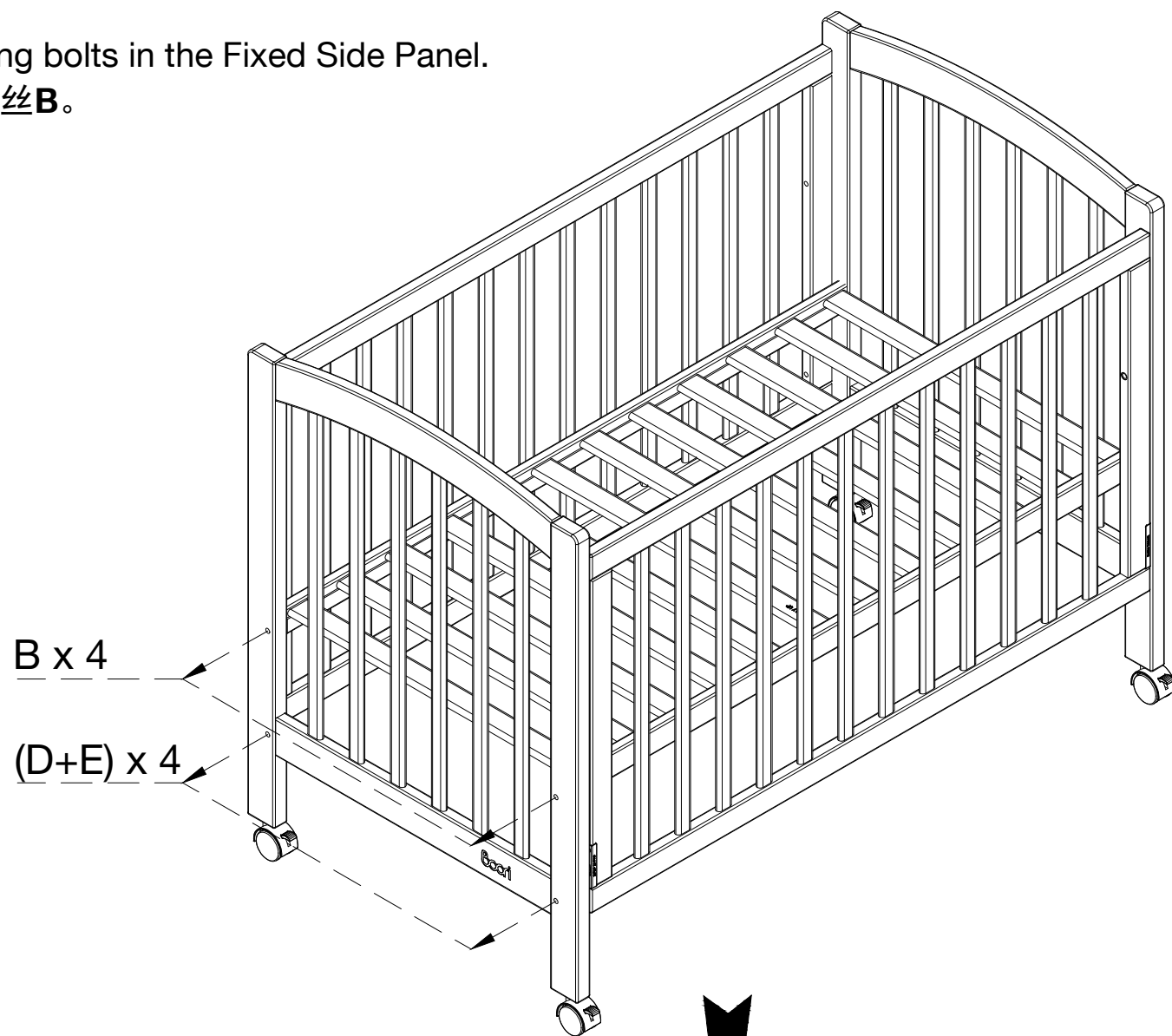

⚠ Base should be in the low position before child is able to sit up.
当宝宝可以坐起时，请将底板降至低孔位的位置，以防止小孩子爬出护栏。

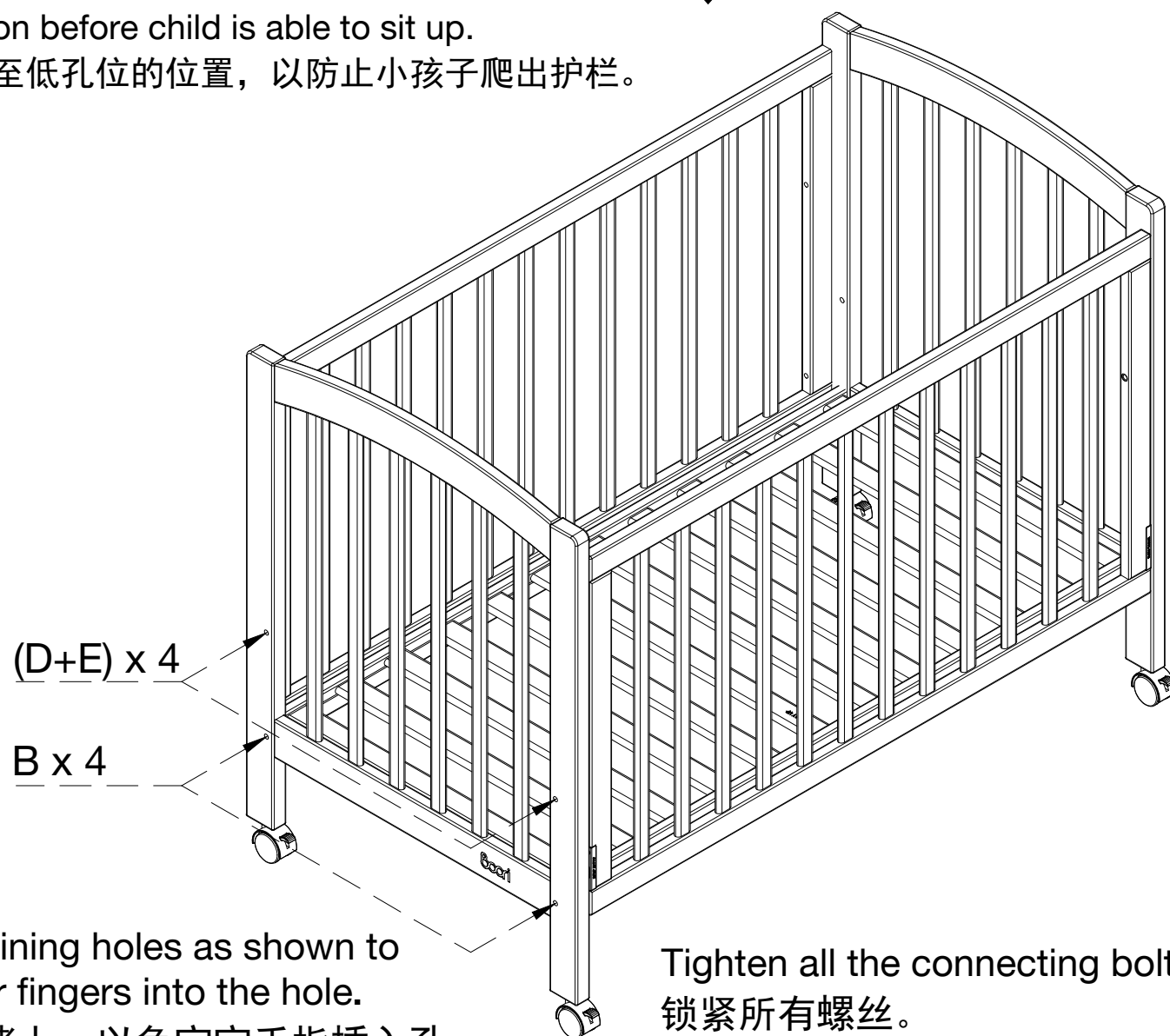

NOTE: Please cover the remaining holes as shown to avoid harm if baby insert their fingers into the hole.
注意：请按图示把剩余的孔堵上，以免宝宝手指插入孔内造成伤害。

Tighten all the connecting bolts.
锁紧所有螺丝。

How to use the Drop Side / 活动护栏使用说明

To lower the Drop Side follow steps 1-3 as shown below.

通过1-3步骤,可降低活动护栏高度,如下图所示。

To raise the Drop Side, raise the Drop Side to its highest position and then release.

若要拉升活动护栏时,可将活动护栏向上拉起至最高点,然后自然放下即可。

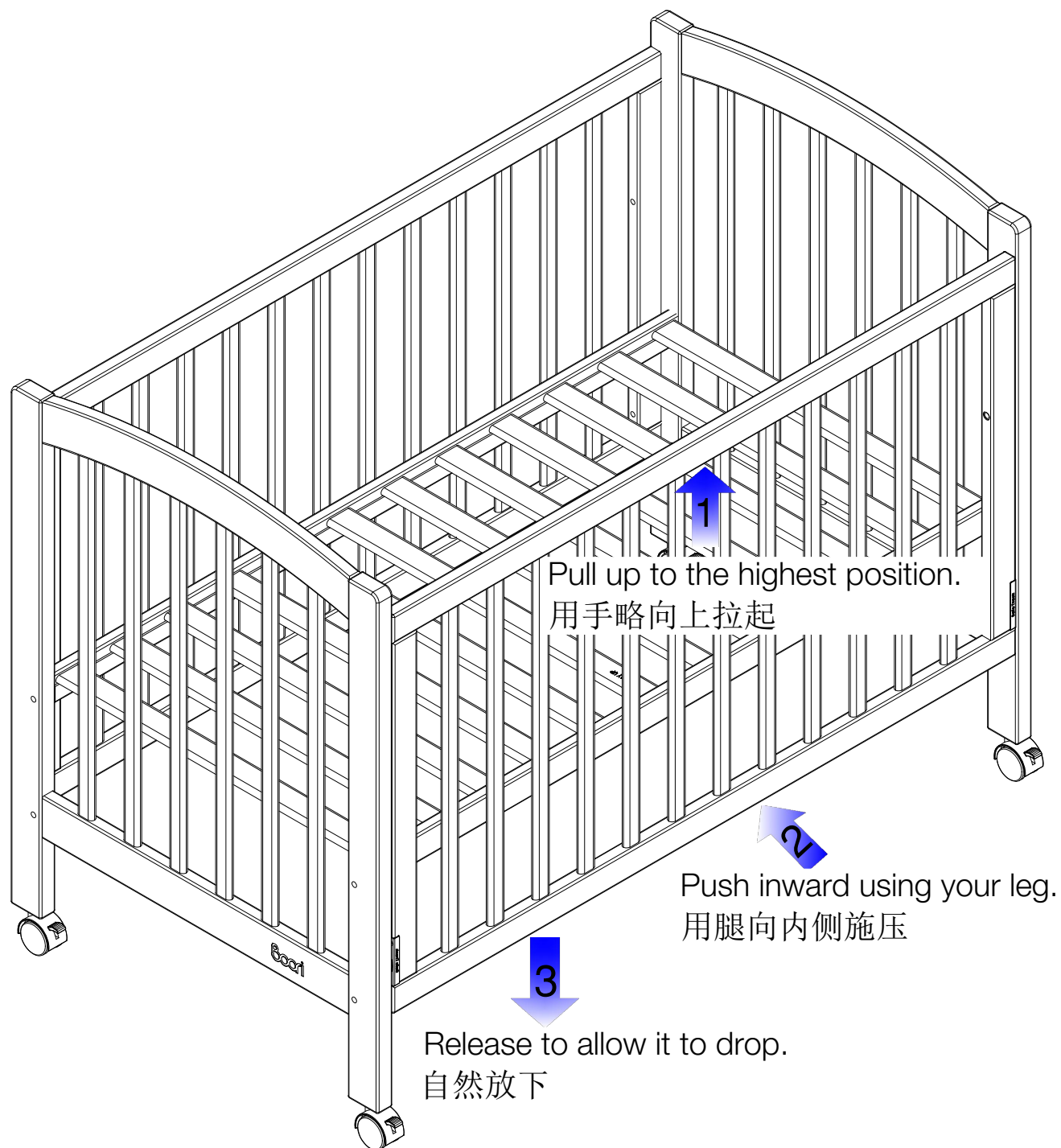

Convert your cot to toddler bed/ 转换成儿童床

1

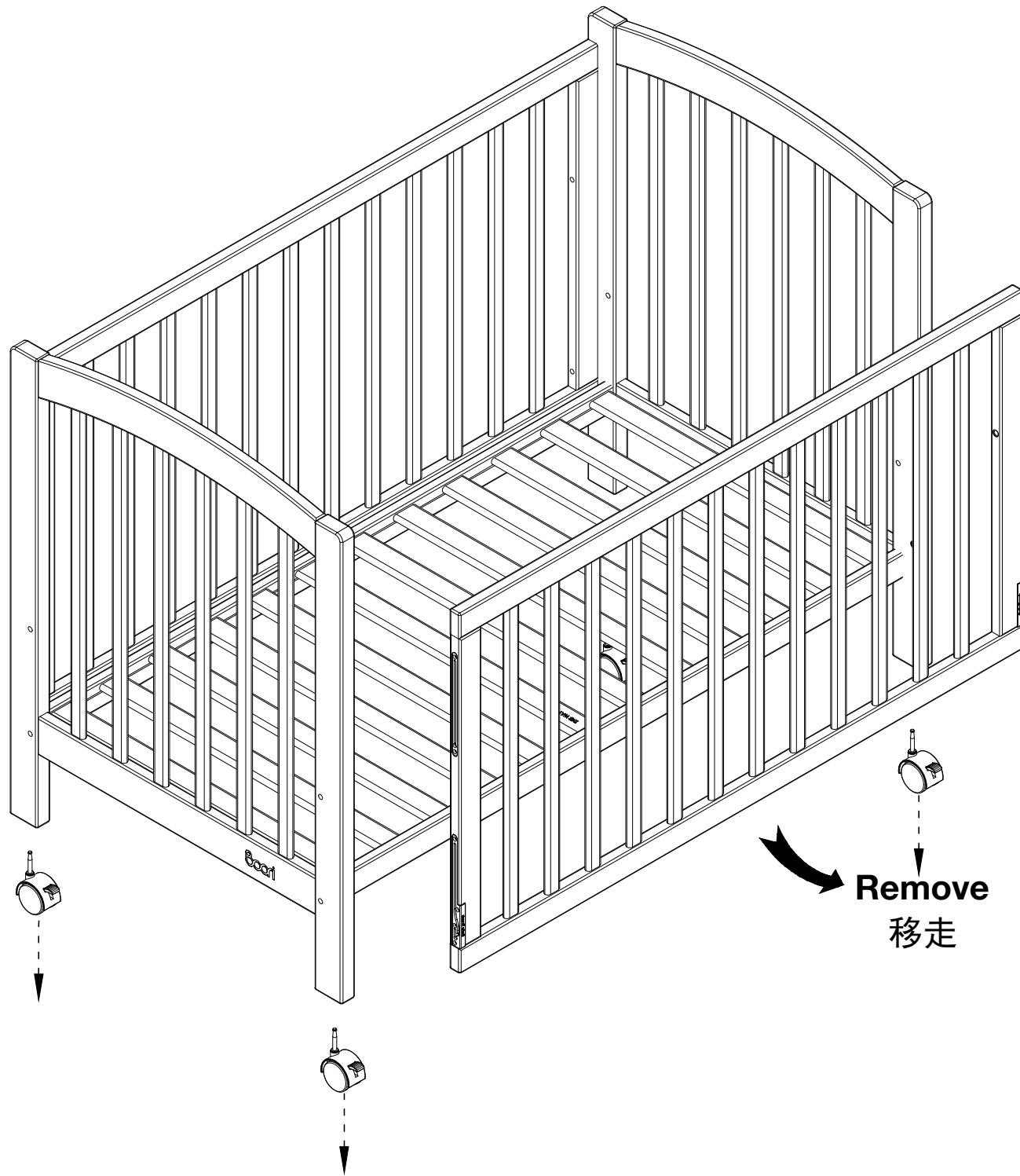

2

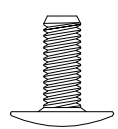
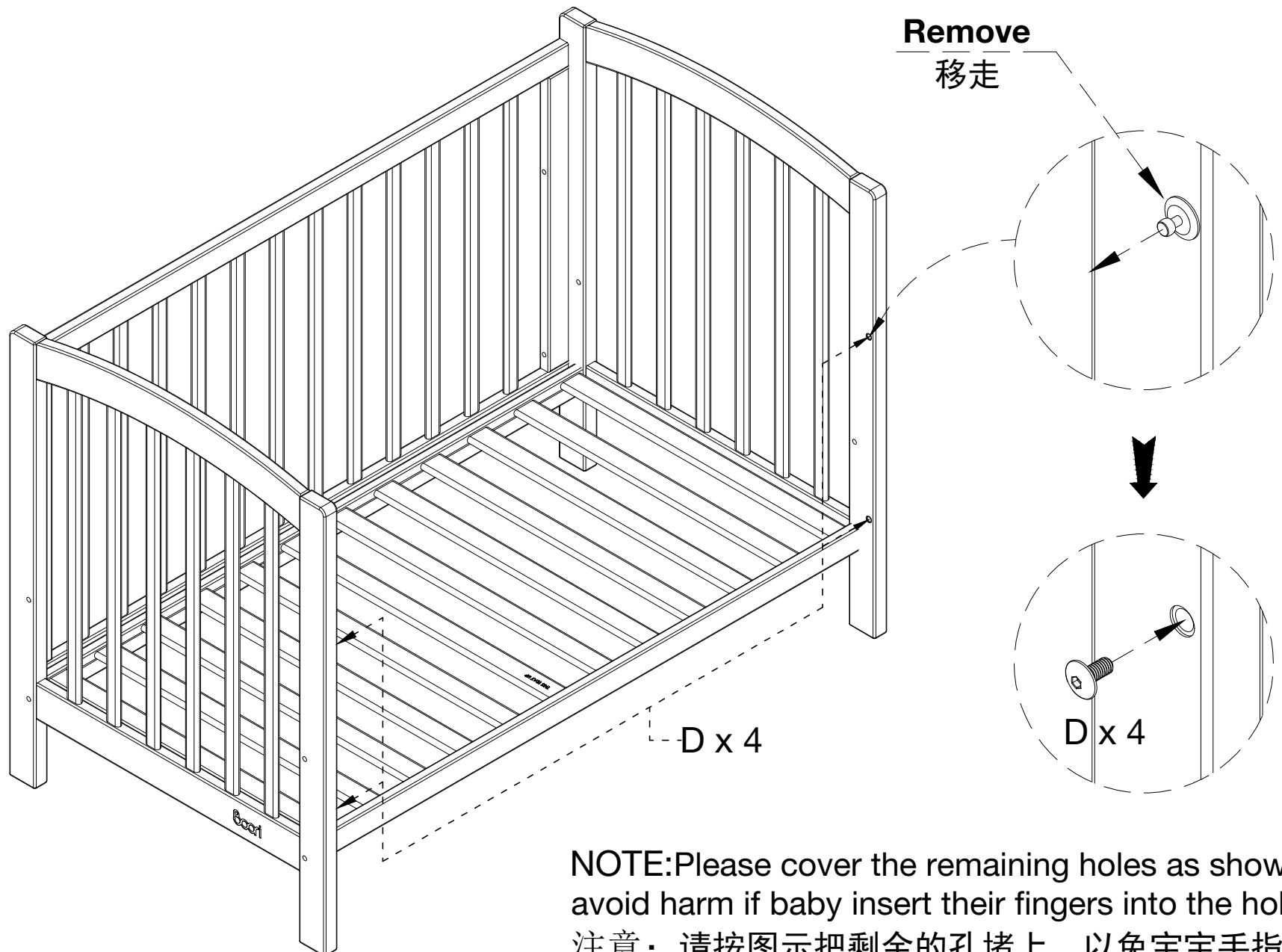

D x 4

NOTE: Please cover the remaining holes as shown to avoid harm if baby insert their fingers into the hole.
注意：请按图示把剩余的孔堵上，以免宝宝手指插入孔内造成伤害。

Assembly instructions

NOTE: Use only spare parts approved by the manufacturer

FOR AUSTRALIA AND NEW ZEALAND (AS/NZS 2172:2013)

RECOMMENDED MATTRESS SIZE 1190mm X 650mm X 110mm

This cot has been manufactured for use with a mattress which measures 650mm wide by 1190mm long and 110 mm in thickness. The width and length are specified because it is important that the gaps between the mattress and the sides and ends of the cot will not exceed 40mm when the mattress is pushed to one side or end, and 20 mm when the mattress is centred in the cot. The thickness of the mattress has been specified to ensure that the depth of the cot is greater than 500 mm with the mattress base in the lower position to minimise the risk of a child climbing or falling out of the cot.

WARNING:

*** TO ENSURE THE SAFETY OF YOUR COT, REGULARLY CHECK ALL THE CONNECTING BOLTS AND GLIDE PINS MAKING SURE THEY ARE TIGHT.**

*** TO PREVENT FALLS OR SUFFOCATION THE MAXIMUM MATTRESS THICKNESS SHOULD NOT EXCEED 110MM**

*** WARNING: TO PREVENT FALLS, THE MATTRESS BASE OF THIS COT SHOULD BE ADJUSTED TO THE LOWEST POSITION BEFORE THE CHILD CAN SIT UP.**

* Follow the manufacturer's assembly instructions in detail to ensure the safety features of the cot are not compromised.

* Ensure the cot is placed at a reasonable distance from curtains, blinds, heaters and power points.

* Keep cot free of any toys, cushions etc that could be used as a foothold or present a danger of suffocation or strangulation.

* Keep medication, String, elastic or small items such as money out of reach from any position in the cot.

FOR THE UK (EN 716-1-2 : 2017)

RECOMMENDED MATTRESS SIZE 1190mm X 650mm x 110mm

If you leave the child unattended in the cot, always make sure that the dropside is in the highest position.

This cot has been manufactured for use with a mattress which measures 650mm wide by 1190mm long and a maximum thickness of 110mm. The width and length shall be such that the gap between the mattress and the sides and ends does not exceed 30mm. The thickness of the mattress has been specified to ensure that the depth of the cot is greater than 500mm with the mattress base in the lower position and 200mm with the mattress in the highest position to minimise the risk of a child climbing or falling out of the cot.

WARNING:

*** TO ENSURE THE SAFETY OF YOUR COT, REGULARLY CHECK ALL THE CONNECTING BOLTS AND GLIDE PINS MAKING SURE THEY ARE TIGHT, CARE SHOULD BE TAKEN THAT NO SCREWS ARE LOOSE BECAUSE A CHILD COULD TRAP PARTS OF THE BODY OR CLOTHING (EG. Strings, necklaces, ribbons for babies dummies), WHICH WOULD POSE A RISK OF STRANGULATION.**

*** TO PREVENT FALLS, THE MAXIMUM MATTRESS THICKNESS SHOULD NOT EXCEED 110MM.**

*** THE LOWEST POSITION IS THE SAFEST AND THE BASE SHOULD ALWAYS BE USED IN THAT POSITION AS SOON AS THE BABY IS OLD ENOUGH TO SIT UP.**

*** TO PREVENT INJURY FROM FALLS WHEN THE CHILD IS ABLE TO CLIMB OUT OF THE COT, THE COT SHALL NO LONGER BE USED FOR THAT CHILD.**

* Be aware of the risk of open fire and other sources of strong heat, such as electric bar fires, gas fires, etc. in the near vicinity of the cot.

* Do not use the cot if any part is broken, torn or missing and use only spare parts approved by the manufacturer.

* Do not leave anything in the cot or place the cot close to another product, which could provide a foothold or present a danger of suffocation or strangulation, e.g. strings, blind/curtain cords, etc.

* Do not use more than one mattress in the cot.

* All assembly fittings should always be tightened properly and that fittings should be checked regularly and retightened as necessary.

WARNING: (BS 8509:2008+A1:2011)

* The child's bed conforms to BS 8509:2008 +A1:2011

* Recommended mattress size 1190mm x 650mm x 110mm

* Suitable for a child from 18 months to 4 years old.

* Do not place this child's bed near heat sources, windows and other furniture.

* Do not use this child's bed if any part is broken, torn or missing.

* The bed is designed to be dismantled for storage or transportation.

* All assembly fittings should always be tightened properly and checked periodically.

* Children are likely to play, bounce, jump and climb on beds, therefore the child's bed should not be placed too close to other furniture or windows, blind cords, curtain pulls or other strings or cords, and should be placed either tight to any wall or have a gap of 300mm between the wall and the side of the bed.



Boori Care Instructions

Congratulations and thank you for choosing Boori product(s). The furniture you have purchased is constructed from high quality materials for strength and durability. Here are some tips on how you can preserve its beauty for a long time.

1. Do not expose furniture to strong sunlight, direct heat sources, extreme changes in temperature or moisture.
2. Wipe up spills immediately with a soft, clean cloth.
3. Urine spills on furniture can cause discolouration.
4. Clean furniture by wiping the surface with a soft cloth dampened with water.
5. If necessary clean furniture using a mild soap solution and wipe clean with a soft cloth dampened with water and then dry with soft clean cloth.
6. Do not use strong household cleaners.
7. Always wipe in the direction of the grain in the wood do not wipe in a circular motion.
8. Avoid contact with sharp objects, or containers containing hot liquid.
9. Avoid contact with 'rubber feet' on items such as radios, computers, telephones etc. Use a felt mat (not plastic) to protect furniture surfaces.
10. Do not open more than one drawer at a time.
11. When moving furniture do not drag always lift and place in position.

Boori Warranty

All Boori wood products carry a full three (3) years manufacturer's warranty as testimony to the quality and longevity of the range. This warranty excludes general wear & tear and damage caused, by the product not being used in accordance with its instructions or the care instructions.

During this guarantee period Boori will replace or repair any defective part. In the event of a product being replaced, as a whole unit or part thereof during the guarantee period, the guarantee on the replacement will expire three (3) years from the original purchase date.

This guarantee excludes accidental damage, misuse and or improper transporting and handling.

The warranty is void if the original product has been altered in design or colour in anyway.

All warranty claims must be lodged at the place of original purchase and proof of purchase must be provided in order to lodge a warranty claim.



Warranty against defects



For Australia only (updated 01/16/2019)

Boori Australia Pty Ltd

26 Peter Brock Drive Eastern Creek Sydney NSW 2766 Australia
PH:(61 2) 9833 3769 FAX:(61 2) 9673 4240
ABN: 43 160 962 354

Boori Care Instructions

Congratulations and thank you for choosing Boori product(s). The furniture you have purchased is constructed from high quality materials for strength and durability. Here are some tips on how you can preserve its beauty for a long time.

1. Do not expose furniture to strong sunlight, direct heat sources, extreme changes in temperature or moisture.
2. Wipe up spills immediately with a soft, clean cloth.
3. Urine spills on furniture can cause discolouration.
4. Clean furniture by wiping the surface with a soft cloth dampened with water.
5. If necessary clean furniture using a mild soap solution and wipe clean with a soft cloth dampened with water and then dry with soft clean cloth.
6. Do not use strong household cleaners.
7. Always wipe in the direction of the grain in the wood do not wipe in a circular motion.
8. Avoid contact with sharp objects, or containers containing hot liquid.
9. Avoid contact with 'rubber feet' on items such as radios, computers, telephones etc. Use a felt mat (not plastic) to protect furniture surfaces.
10. Do not open more than one drawer at a time.
11. When moving furniture do not drag, always lift and place in position.

Boori Warranty (“this Warranty”)

All Boori Collection wood products (“Boori Wood Products”) carry a full three (3) years manufacturer’s warranty (“Warranty Period”) to the end-purchaser (“the Customer”) as testimony to the quality and longevity of the range. This warranty excludes general wear & tear and damage caused, by the Boori Product not being used in accordance with its instructions or the care instructions. During this Warranty Period Boori Australia Pty Ltd (ABN 43 160 962 354) (“Boori”) will replace or repair any defective part. In the event of a Boori Product being replaced, as a whole unit or part thereof during the Warranty Period, the warranty on the replacement will expire three (3) years from the original purchase date.

This guarantee excludes accidental damage, misuse and or improper transporting and handling.

The warranty is void if the original Boori Product has been altered in design or colour in anyway.

All warranty claims must be lodged:

- 1. at the place of original purchase as set out on your receipt for purchase of the Boori Products or you may contact Boori on 9833 3769 to obtain further details;and**
- 2. together with a proof of purchase.**

Where the Customer makes a claim pursuant to this Warranty, all expenses incurred in sending the Boori Products to Boori are the Customer's responsibility.

Boori's liability in respect of a breach of a consumer guarantee or any warranty made under this Warranty for any Boori Products not of a kind ordinarily acquired for personal, domestic or household use is limited, in relation to the Boori Products to the extent permissible by law and at it's option to:

1. replacing the Boori Products or the supply of equivalent Boori Products;
2. the repair of the Boori Products;
3. the payment of the cost of replacing the Boori Products or of acquiring equivalent goods; or
4. the payment of the cost of having the Boori Products repaired.

To the extent permitted by law, all other warranties whether implied or otherwise, not set out in this Warranty are excluded and Boori is not liable in contract, tort (including, without limitation, negligence or breach of statutory duty) or otherwise to compensate the Customer for:

1. any increased costs or expenses;
2. any loss of profit, revenue, business, contracts or anticipated savings;
3. any loss or expense resulting from a claim by a third party; or
4. any special, indirect or consequential loss or damage of any nature whatsoever caused by the Customer's failure in complying with its obligations.

Limitations on Warranty Disclaimers

In the following paragraph, 'Our' means 'Boori', 'You' means 'the Customer' and 'goods' means 'Boori Products':

Our goods come with guarantees that cannot be excluded under the Australian Consumer Law. You are entitled to a replacement or refund for a major failure and for compensation for any other reasonably foreseeable loss or damage. You are also entitled to have the goods repaired or replaced if the goods fail to be of acceptable quality and the failure does not amount to a major failure.

The benefits given to the Customer in this Warranty are in addition to other rights and remedies under a law in relation to the Boori Products to which this warranty applies.

一、产品检验标准

产品甲醛释放量：合格

执行标准：QB 2453.1-1999

QB/T 2453.2-1999

GB 18584-2001

EN 716-1-2: 2017

BS 8509:2008+A1:2011

AS/NZS 2172-2013

二、信心质保

(一) 我们对所有Boori产品提供长达三年质保。

(二) 三包服务范围：

1. 包修: 凡属产品本身质量问题的一律免费维修或者提供补件。因顾客自行运输、安装及使用维护不当造成的问题，本公司负责收费维修或补件。
2. 包换: 一年内，同一缺陷经两次修理未能达到质量标准的包换，更换后的产品保修期从更换之日起重新计算。
3. 包退: 在包修期限内，同一缺陷经两次修理、调换后仍无法达到质量标准的，在约定期限内不能调换的，经检验为不合格的。

(三) 本质保不包括产品正常使用损耗、不按照使用说明书使用而造成的产品损伤破坏，不包括由于运输、安装、使用过程不当造成的意外损坏。如果产品被顾客改装或是故意损坏，也不在保修范围之列。三包”范围属下列情况之一者，不实行“三包”服务，可酌情收费修理。

1. 消费者因使用、维护、保管不当造成损坏的；
2. 自行拆动造成损坏的；
3. 无“三包”凭证及有效发票的，又不能证明其所购产品在“三包”有效期内；
4. “三包”凭证号与修理产品型号不符合或者涂改的；
5. 超过“三包”期限的。

(四) 运费说明：

1. 因产品质量问题产生的来回运费由我公司承担。
2. 因顾客因素造成的补件和返厂维修及退货等，来回运费由顾客承担。
3. 由于顾客自己找物流公司，很容易碰到乱要价，价格虚高的问题，我公司已与合作物流达成战略合作。如需寄回，请联系客服。

三、常见问题FAQ

(一) 关于澳大利亚Boori

Boori源自澳大利亚，始于1993，国际专业婴童房家具品牌，二十五年专注婴童家具设计与制造，产品受到全球超过800家高端商厦信赖，如欧洲Harrods商厦、澳洲David Jones百货、英国John Lewis连锁百货等，畅销澳洲、欧洲、美国、日本、韩国、中国等国家及地区，品质享誉全球，现已成功打造出两个品牌“Boori”和“BooriKIDS”，主要产品涵盖婴儿床、儿童床、早教、学习桌椅、衣柜等儿童与青少年家具，全面考虑儿童房睡眠、储物、学习、娱乐、教育等生活要素，真正打造0-18岁概念的婴童房。

(二) Boori家具的用材是什么

Boori家具甄选50年以上树龄进口实木，木材通过FSC安全认证，生长过程中不使用任何化学杀虫剂，砍一种一，绿色环保可持续；Boori更是通过美国权威UL绿色环保金奖认证的婴童家具企业，可安心让孩子们使用，收到产品后，可先将产品放到阴凉通风处静置几日即可放心使用，可消除因严密包装产生的味道。

(三) Boori家具用的是什么涂层？

我们使用的是水性生物基涂料，简称生物基，是指利用可再生物质为原料，包括农作物、树木、其它植物等通过可再生技术制作而成的一种新型植本涂料，有机挥发物极低，进一步降低对家人和孩子的伤害，做到更安全、环保，对于喜欢啃食的宝宝，为宝宝设置一道天然保护层；涂层表面晶莹剔透、温润触感，并且具有耐水、耐磨、耐老化、干燥快、使用方便等特点，为孩子创造更舒适放心的居住环境。

(四) 为什么要选用Boori配套的床垫

床垫的材质和尺寸对孩子睡眠来讲非常重要，Boori床垫专为Boori婴童床设计，运用天然及高科技材料，科学搭配，健康护脊，尺寸专为Boori婴童床研制，为宝宝的成长提供最安全舒适的睡眠环境。

(五) 如何购买单独配件

如果您需要购买单独配件，请联系客服400-865-1128

(六) 如何了解Boori更多信息

官网：www.boori.com 官微：搜索公众号“Boori”并关注

四、安装指导及注意事项

- (一) 只有当折叠系统的锁定机械装置被啮合时，折叠小床才能使用；
- (二) 本婴童床的床铺面高度可调节，最低位置是最安全距离。当婴童大到能够坐起时，应当保证其床铺面保持在最低位置；
当孩子在婴童床内无成人陪伴时，要始终确保护栏处于最高位置；
- (三) 如果婴童床配备可拆开撑杆，当婴童床在最低位置上使用前，必须移去这些撑杆；
- (四) 请勿遗留任何可能给孩子提供立足点、缠绕点的东西或不透气覆盖物在婴童床内，因为这些东西可能导致婴儿勒死，也有可能导致婴儿闷死；
- (五) 当床铺面处于最低位置时，应该使内高(从床垫表面到床框架的上侧边)至少为500mm，而当床铺面处于最高位置时，应该使内高至少为200mm；
- (六) 所有安装配件应该适当紧固以及注意没有一个螺钉松动，因为一个儿童能够使部分身体或衣服（如串线、项圈、玩具娃娃用的丝带等等）陷入困境，可能造成勒死危险。
- (七) 推荐床垫尺寸：长1190mm*宽650mm，配套床垫厚度切勿超过110mm，防止婴童翻出；
- (八) 警告：不可在童床附近点燃火源或其他强热源，例如电取暖器、煤气取暖器等等。
- (九) 请务必按照说明书安装堵孔螺丝；
- (十) 孩子可自主上下床之后，家长可将婴童床转换为儿童床状态；
- (十一) 如果您购买的婴童床可转换为单人床或双人床，请根据孩子的实际成长状况适时转换。

五、家具保养

为了使您的Boori婴童房保持最佳状态，我们对Boori家具的日常保养提供如下建议：

1. 避免强光直射，远离热源。
2. 用柔软洁净布料直接擦拭灰尘。
3. 如有需要，请用柔软洁净的湿布蘸取中性清洁剂擦拭油污，并立马擦干。
4. 请顺纹理擦拭，避免打圈移动。
5. 避免使用家庭强力去污剂。
6. 避免接触尖锐物体、热液体。
7. 避免将橡胶底座的物品放置到家具上，比如收音机、电脑或是电话。
8. 表面使用毡布覆盖保护(勿用塑料材质)。

9. 避免同时抽出两个及以上抽屉。
10. 移动家具时一定要抬离地面并平放至水平位置，避免拖拽。
11. 避免暴露在极端变化的温度与湿度下，这会损坏木制品，不要将家具放在空调出风口、壁炉、散热器、空间加热器或除湿器附近，避免近火或强热源。
12. 避免家具受到阳光直射，紫外线会使产品褪色，在一些情况下还会使颜色变暗，会使表面植物油产生龟裂或毛细裂纹。白色会慢慢自然变暗，是由于木材会因外界环境变化而产生一些颜色改变，从而导致家具表面植物油颜色随之改变，但这不属于质量缺陷，是实木家具所具有的一种特性。

我们对Boori床垫的日常保养提供如下建议：

1. 定期改变受力点。床垫建议在前三个月内每个星期，左右反转一次，之后每2-3个月左右反转一次，这样可以确保床垫更加耐用。
2. 保持清洁。可使用吸尘器除去灰尘及尘螨，如果床垫上任何污迹或液体，可用少量冷水混入温和去污剂清理并迅速用吸水纸吸干，切勿把床垫浸在水中或其他液体里，特别是有椰棕填充的床垫。
3. 请避免使用酸碱化学物品清洁床垫，酸碱化学物品不仅会损床垫，更会影响婴童身体健康。
4. 保护好床垫，最佳方法是加一张保洁垫，因保洁垫比较容易取下，能通风透气去除异味，使床垫更卫生、更加耐用。
5. 使用棕垫时定期2-3个月将棕垫晾晒，保持干爽，延长使用年限。
6. 使用时去掉塑料包装袋，以保持环境通风干爽，避免床垫受潮。

六、退换货流程

如需退换货，请您按照以下流程操作。工作日客服会在12小时内进行处理，非工作日客服会在恢复工作日后12小时内处理。

1. 请保证货品及包装完好，不影响二次销售。
2. 请第一时间联系客服，如有质量问题，请及时拍照传给客服。
3. 与客服联系并协商一致后，请用一张小纸条写上您的退换货原因、退货商品型号、退货商品有无存在质量问题、您的收货地址和联系方式，将纸条放在包装内，将货物寄回。

七、联系方式

售后服务联系电话：400 865 1128。

退换货地址：浙江省嘉兴市南湖区七星街道都市经济产业园(东大路西)浙江瀚豪实业有限公司，Boori仓库收，0573-8388 5718。