

MODE

Assembly Instruction

Item Code: USFQ013

Description: MODE Osten Bookcase

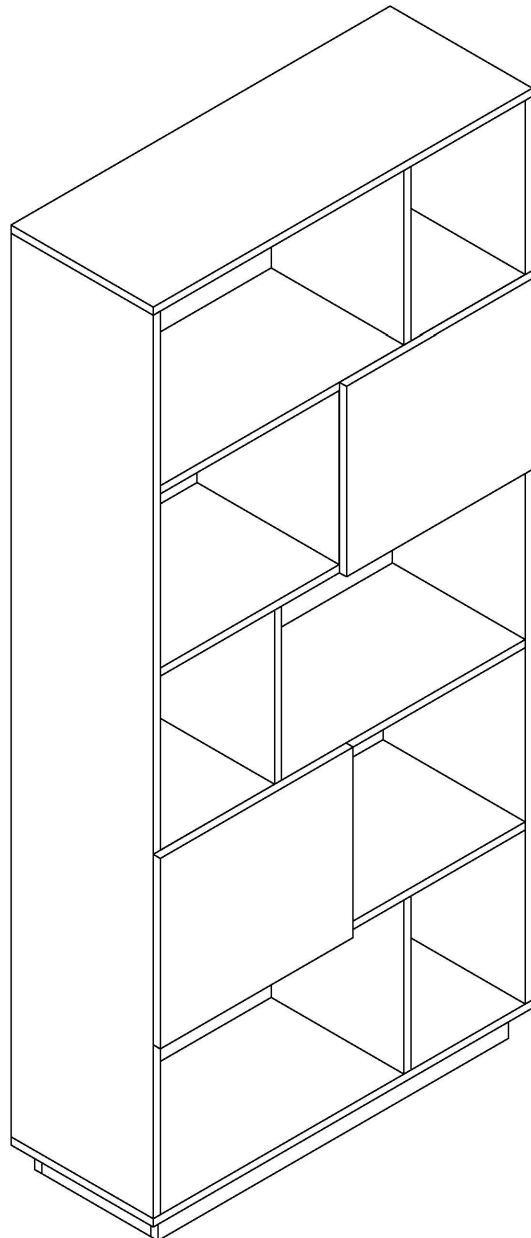

Important Tips and Maintenance

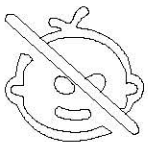

1. Keep children and animals away from working area as smaller parts may cause choking if swallowed.

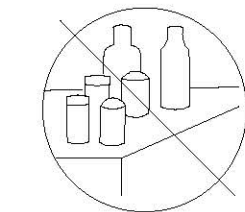

2. Never place liquids or anything damp upon furniture as it will mark. Ensure a coaster or running is beneath.

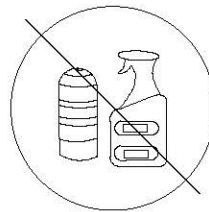

3. Never use ammonia based cleaning products as it will damage the finish.

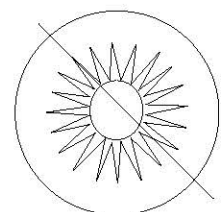

4. To avoid fading, keep furniture out of direct sunlight.

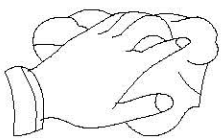

5. Use a soft or damp cloth (dry cloth) when wiping or cleaning surfaces.

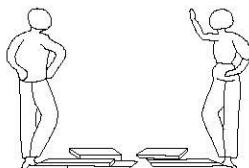

6. Two person are required.

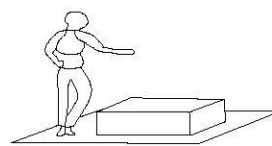

7. Lay a soft matt down to protect the furniture piece before and during assembly.

So your relationship is strong. But is it flat-pack furniture strong? Unless you're an aerospace engineer, assembling furniture can be slightly stressful. We recommend meditating quietly, pouring yourself a herbal tea (or slightly less herbal wine) and tackling things one step at a time. If you feel a passive aggressive remark coming on, try a compliment instead. E.g. "You're so good looking"

This 12-step assembly should take around 2 hours with an Allen Key - or 1.5 hours with an electric drill. Godspeed.

Designed for everyday

Before Assembly

Tips Before Your Start:

- Remove all wrapping material, including staples & packing straps before you start to assemble.
- DO NOT tighten all screws and bolts until completely assembled.
- Keep all hardware parts out of reach of children.

QUICKFIT

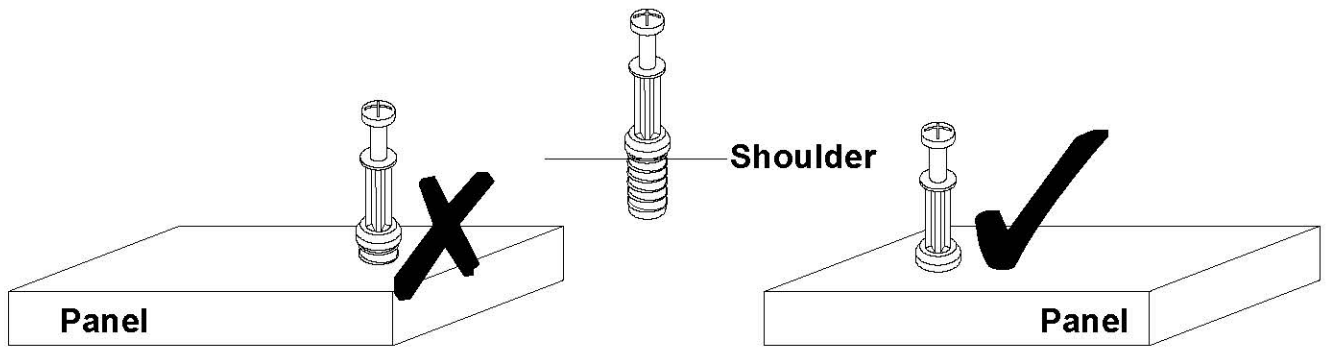

Tighten quickfit until shoulder is flush with panel. Do not overtighten or undertighten.

CAM LOCK

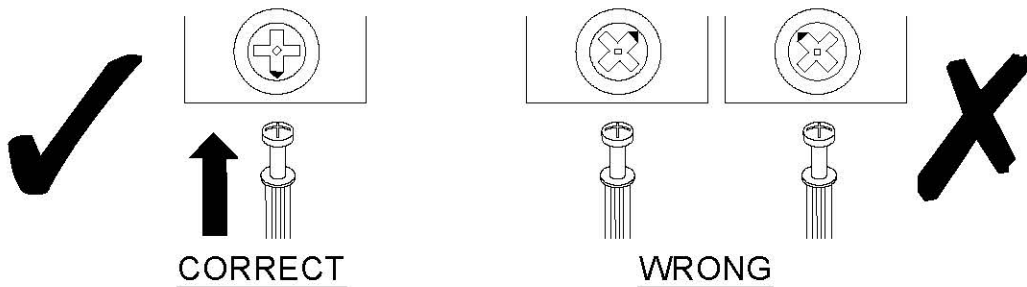

When fitting cam lock, ensure starting position is correct before you insert connecting quickfit.

Quickfit head should be in the centre of the cam lock when the two panels are joined.

Cam lock should be inserted before quickfit.

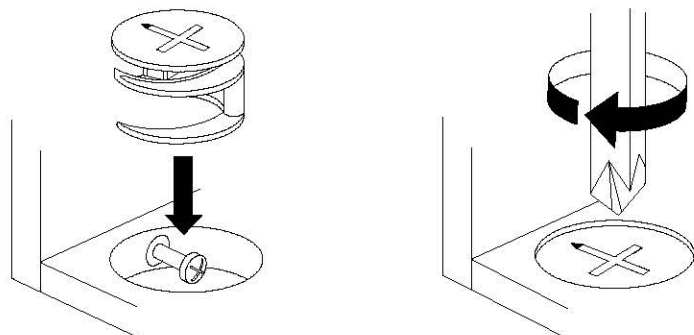

Turn cam lock clockwise to tighten.

Component Hardware

Please check you have all the fittings part or tools are listed in below.

No. A
Quantity:66Pcs
Cam Lock Dowel
8*28mm



No. B
Quantity:26Pcs
Dowel
8*30mm



No. C
Quantity:66Pcs
Cam
φ15



No. D
Quantity:8Pcs
Screw
4*16mm



No. E
Quantity:6Pcs
Foot Nail



No. F
Quantity:4 Pcs
Hinge

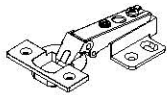

No. G
Quantity:16 Pcs
Screw
4*12mm



No. H
Quantity:2Sets
Anti-falling Parts



No. I
Quantity:66Pcs
Sticker



Component Panels & Part List

Please check you have all the panels are listed below.

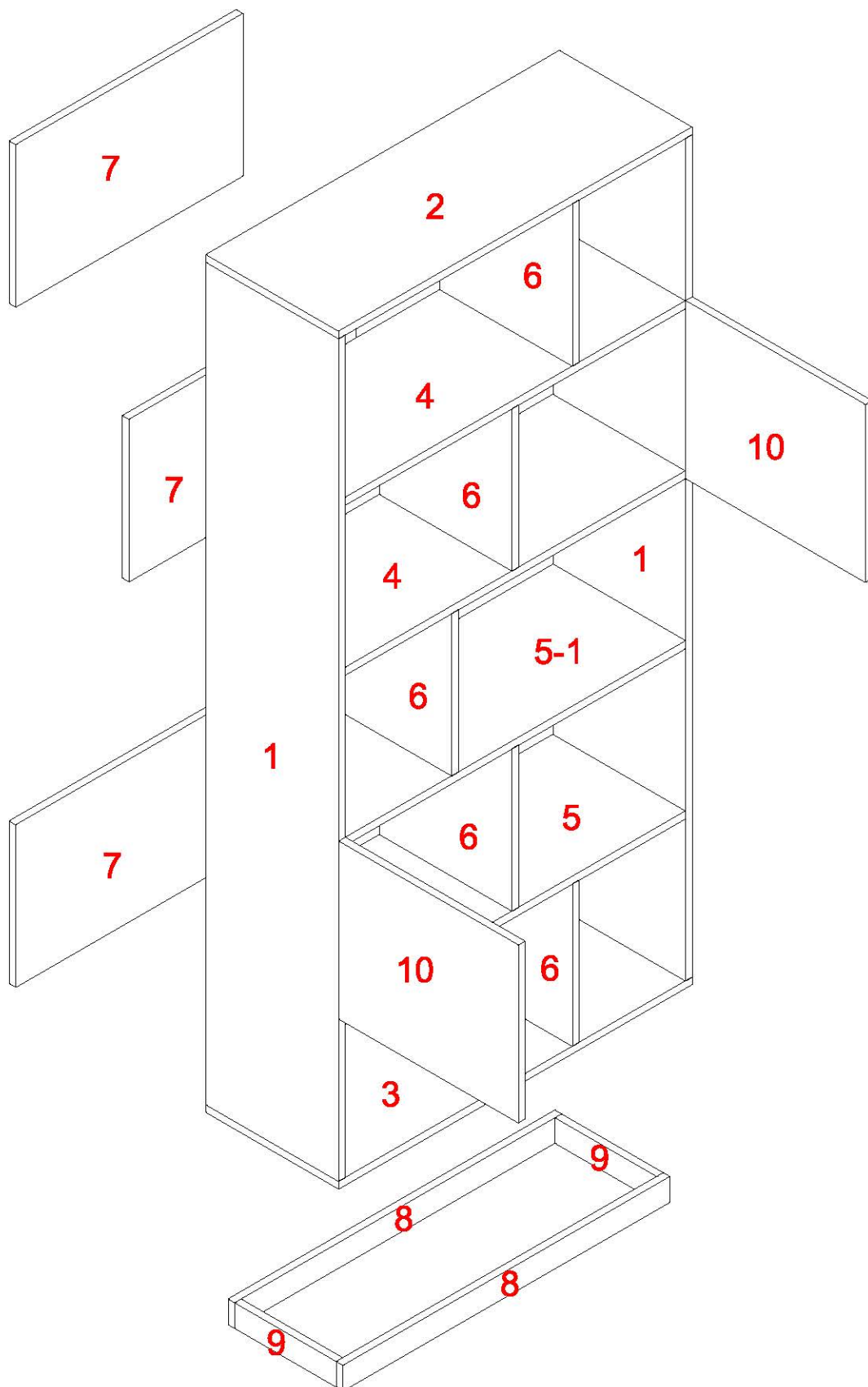

STEP 1

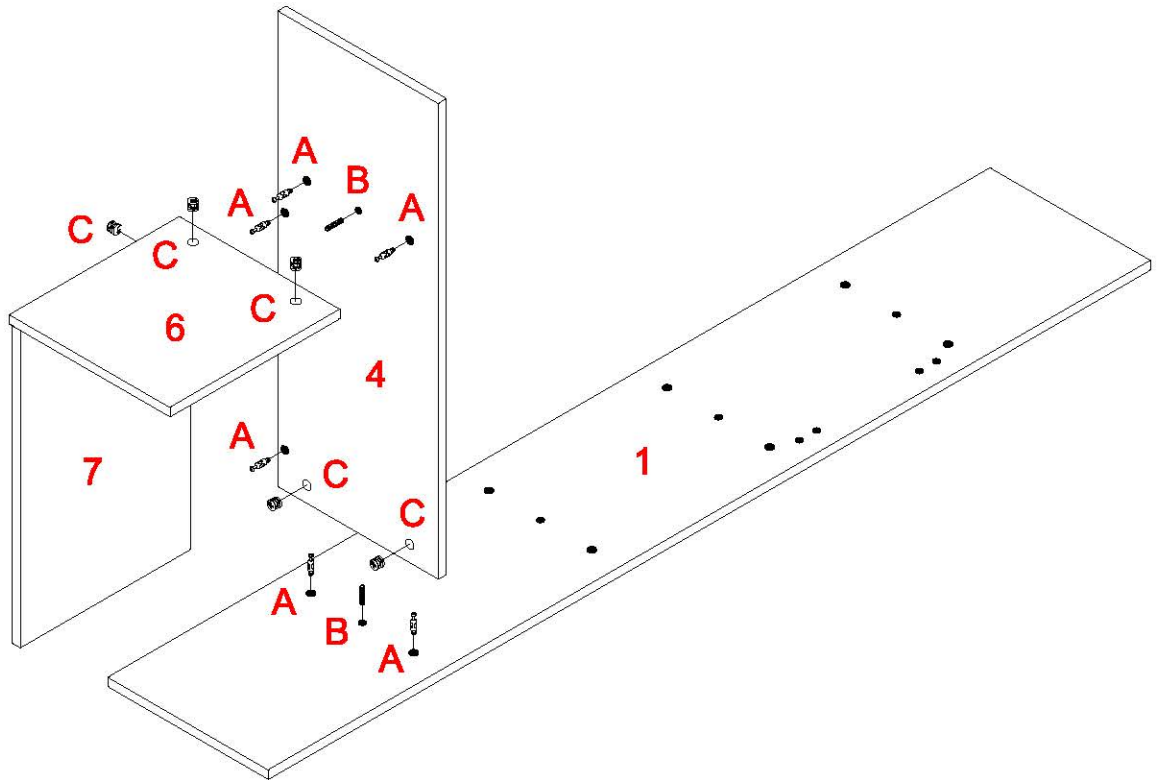

No. A
Quantity: 6Pcs
Cam Lock Dowel
8*28mm



No. B
Quantity: 2Pcs
Dowel
8*30mm



No. C
Quantity: 6Pcs
Cam
φ15



STEP 2

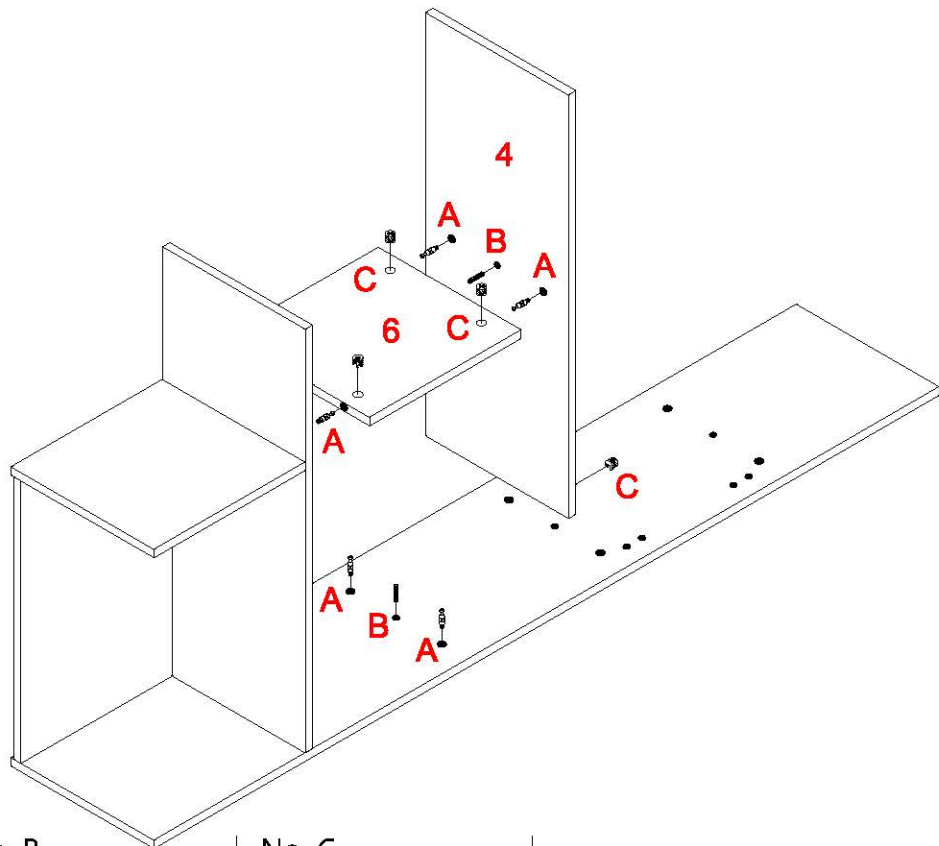

No. A
Quantity: 6Pcs
Cam Lock Dowel
8*28mm



No. B
Quantity: 3Pcs
Dowel
8*30mm



No. C
Quantity: 6Pcs
Cam
φ15



STEP 3

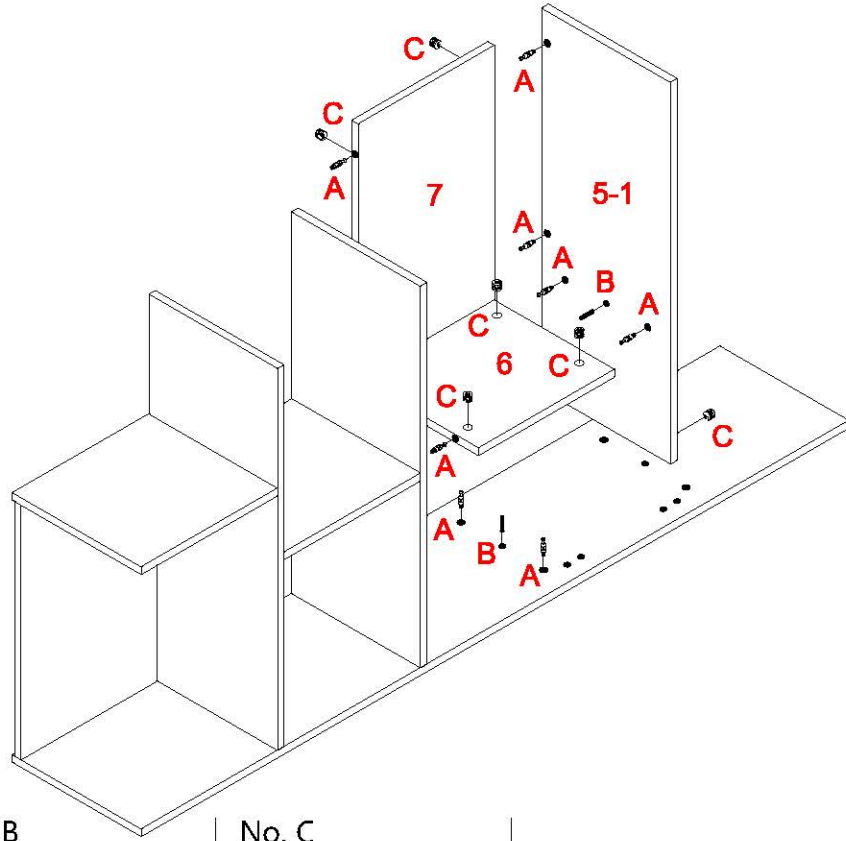

No. A
Quantity: 10Pcs
Cam Lock Dowel
8*28mm



No. B
Quantity: 3Pcs
Dowel
8*30mm



No. C
Quantity: 10Pcs
Cam
φ15



STEP 4

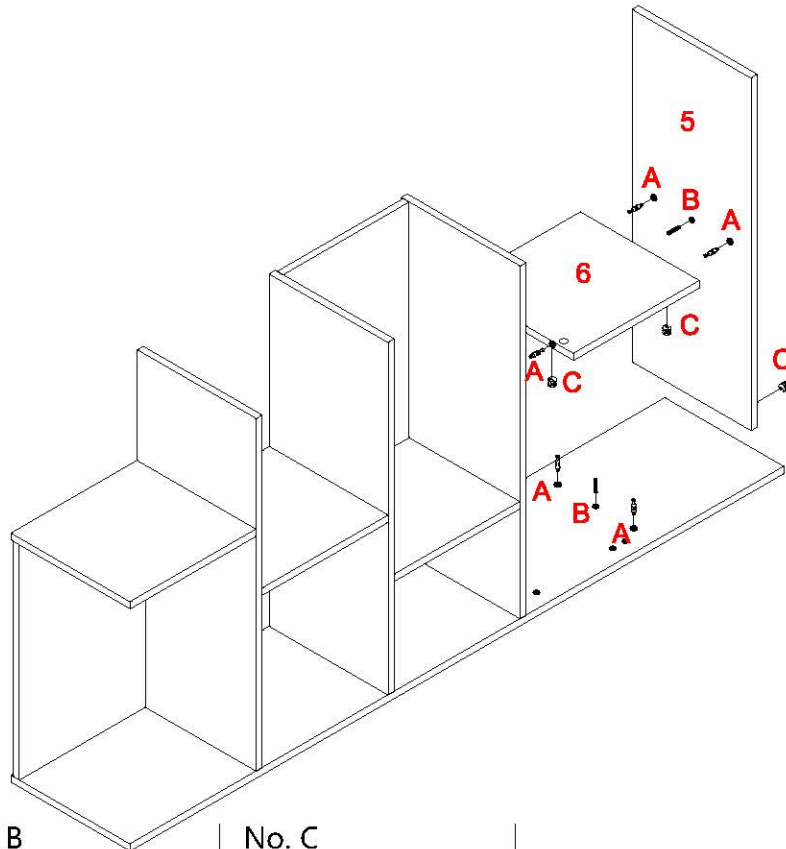

No. A
Quantity: 6Pcs
Cam Lock Dowel
8*28mm



No. B
Quantity: 3Pcs
Dowel
8*30mm



No. C
Quantity: 6Pcs
Cam
φ15



STEP 5

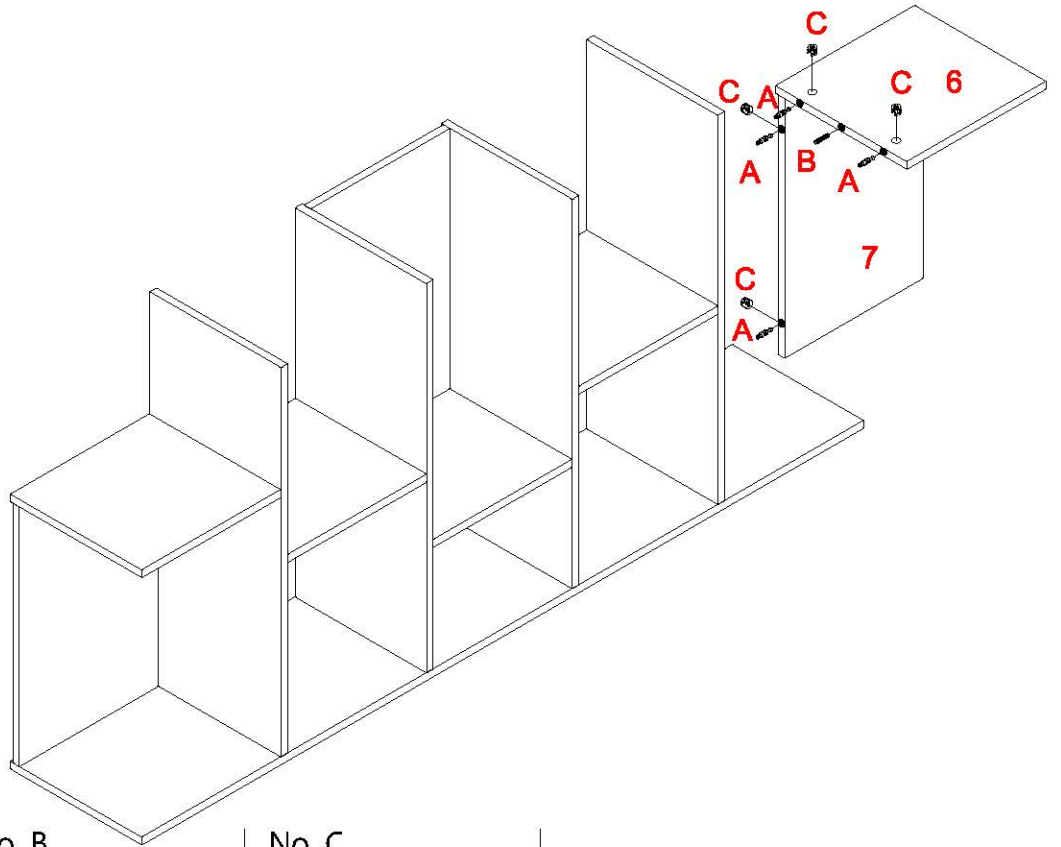

No. A
Quantity: 4Pcs
Cam Lock Dowel
8*28mm



No. B
Quantity: 1Pcs
Dowel
8*30mm



No. C
Quantity: 4Pcs
Cam
φ15



STEP 6

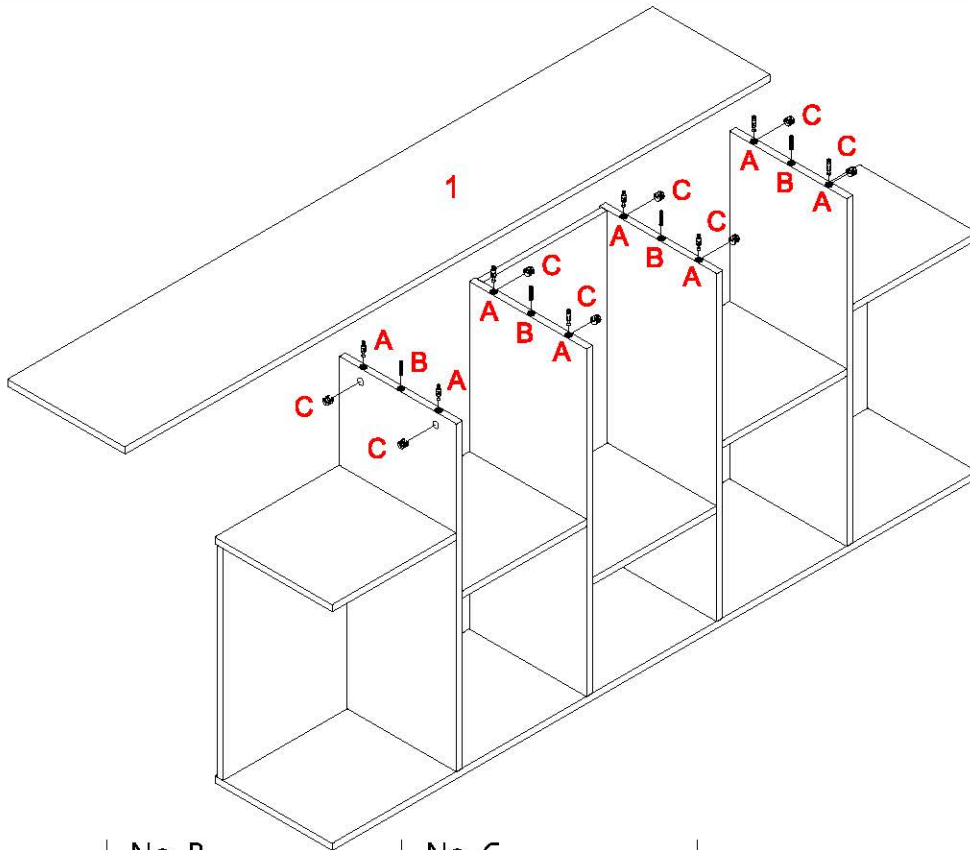

No. A
Quantity: 8Pcs
Cam Lock Dowel
8*28mm



No. B
Quantity: 4Pcs
Dowel
8*30mm



No. C
Quantity: 8Pcs
Cam
φ15



STEP 7

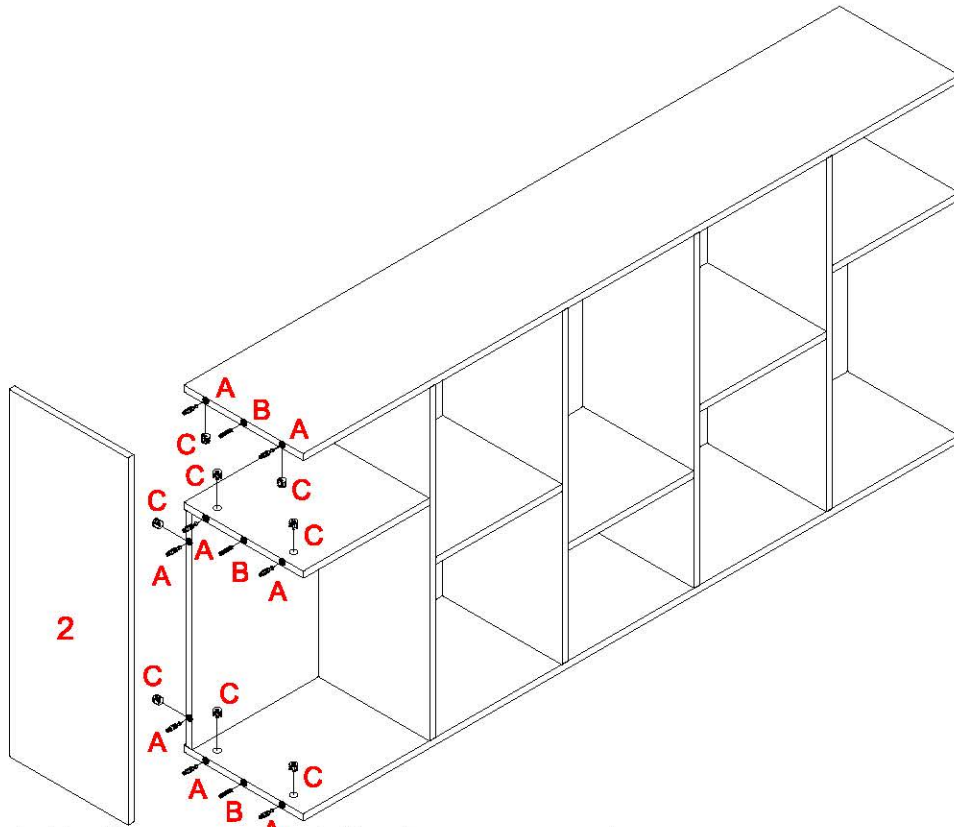

No. A
Quantity: 8Pcs
Cam Lock Dowel
8*28mm



No. B
Quantity: 3Pcs
Dowel
8*30mm



No. C
Quantity: 8Pcs
Cam
φ15



STEP 8

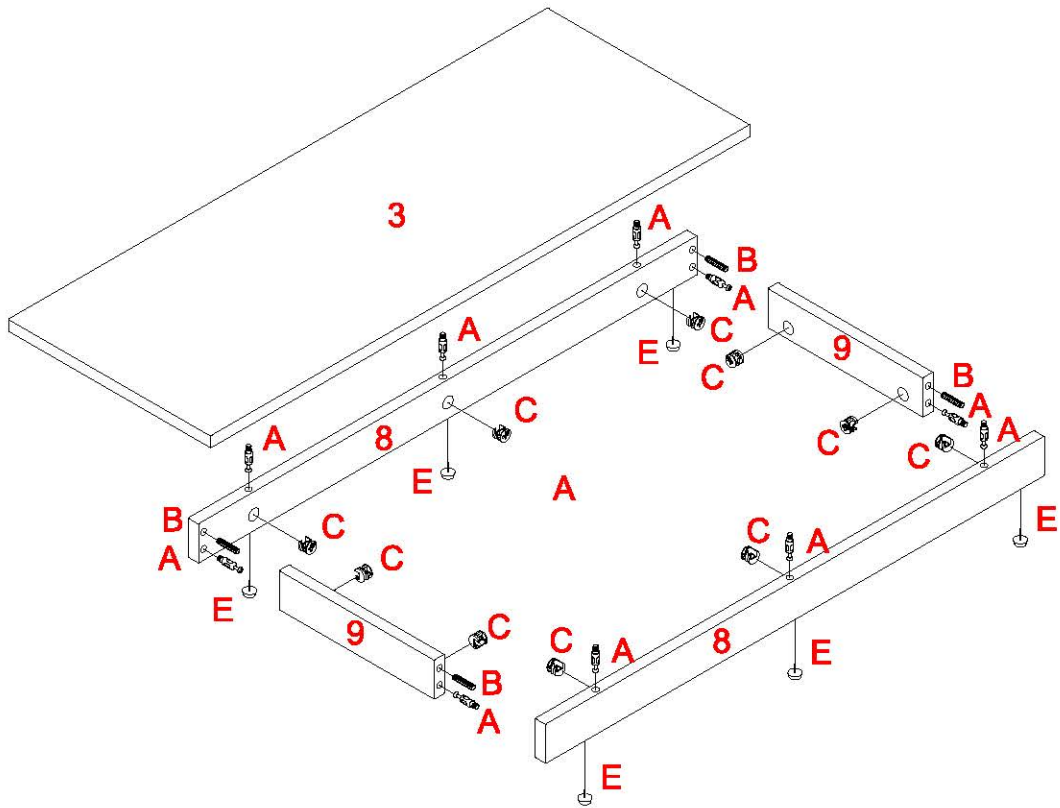

No. A
Quantity: 10Pcs
Cam Lock Dowel
8*28mm



No. B
Quantity: 4Pcs
Dowel
8*30mm



No. C
Quantity: 10Pcs
Cam
φ15



No. E
Quantity: 6Pcs
Foot Nail



STEP 9

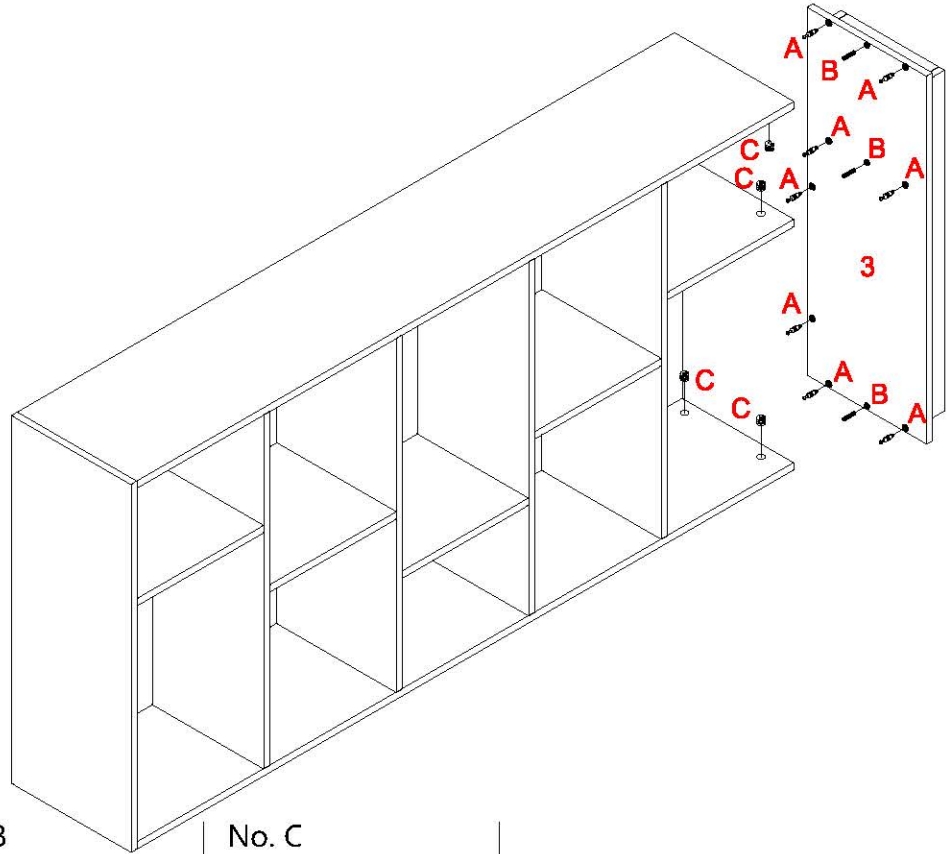

No. A
Quantity: 8Pcs
Cam Lock Dowel
8*28mm



No. B
Quantity: 3Pcs
Dowel
8*30mm



No. C
Quantity: 8Pcs
Cam
φ15



STEP 10

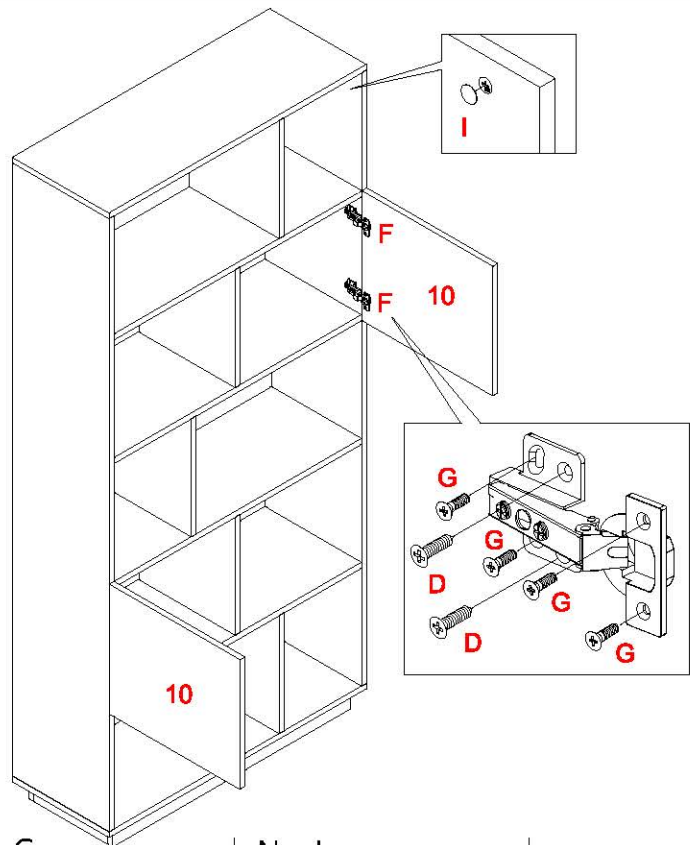

No. D
Quantity: 8Pcs
Screw
4*16mm



No. F
Quantity: 4 Pcs
Hinge

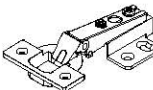

No. G
Quantity: 16 Pcs
Screw
4*12mm



No. I
Quantity: 66Pcs
Sticker



STEP 11

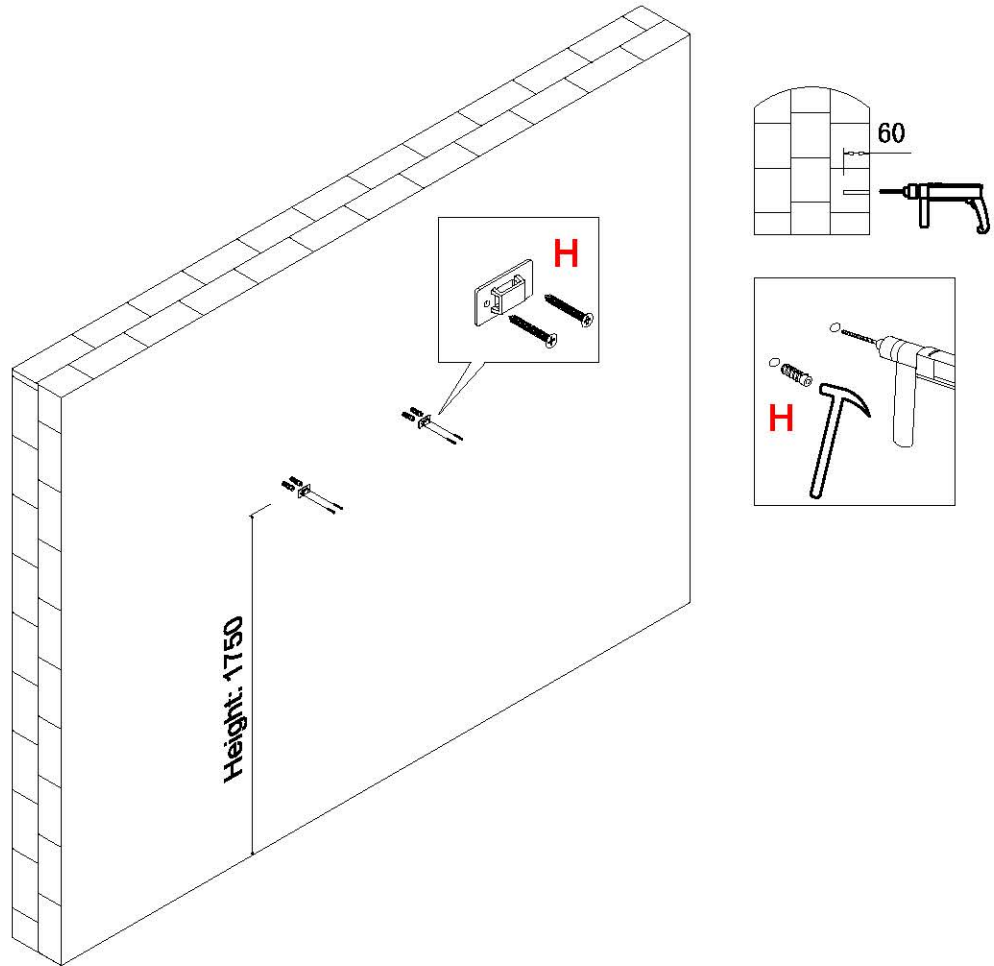

STEP 12

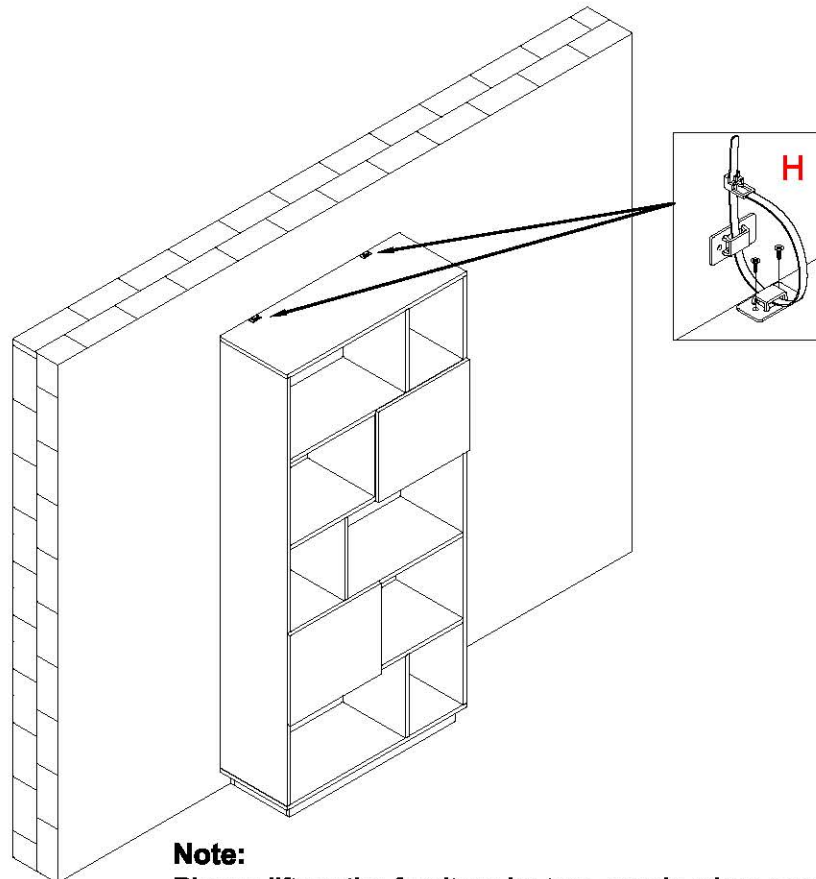

No. H
Quantity: 2Sets
Anti-falling Parts

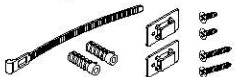

Note:
Please lift up the furniture by two people when moving is needed.
Dragging may cause the legs failure.