

# Assembly Instructions

Knight Series

Max load: 4kgs

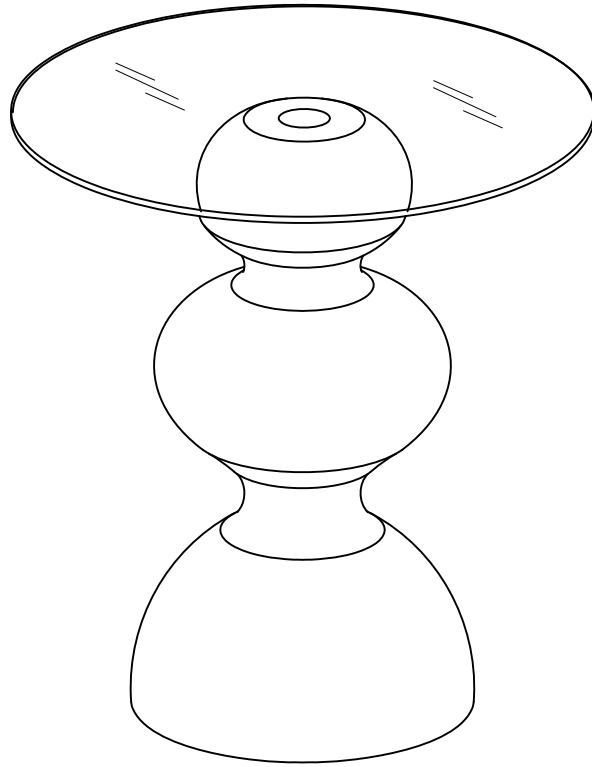

# Lifely\*

## Product Code

KNT-ST-WHT Knight Side Table

## Dimensions (W x D x H)

432\*432\*490mm

---

## Important

Please read through instruction carefully  
Before assembly and keep for future reference.

For our full catalogue of assembly instructions,  
Visit: [lifely.com.au/assembly](http://lifely.com.au/assembly).

## Important Tips and Maintenance

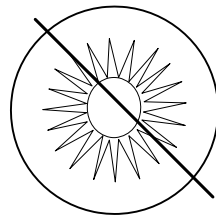
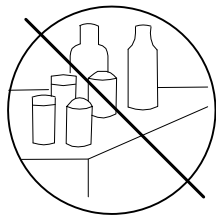
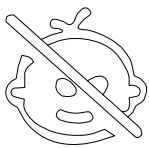

1. Keep children and animals away from working area as smaller parts may cause choking if swallowed.

2. Never place liquids or anything damp upon furniture as it will mark. Ensure a coaster or running is beneath.

3. Never use ammonia based cleaning products as it will damage the finish.

4. To avoid fading, keep furniture out of direct sunlight.

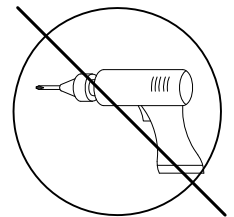
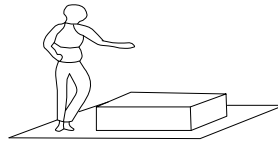
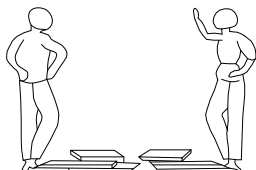
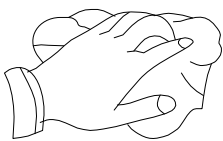

5. Use a soft or damp cloth(dry cloth)when wiping or cleaning surfaces.

6. Two person are required.

7. Lay a soft matt down to protect the furniture piece before and during assembly.

8. NO POWER TOOLS

So your relationship is strong. But is it flat-pack furniture strong? Unless you're an aerospace engineer, assembling furniture can be slightly stressful. We recommend meditating quietly, pouring yourself a herbal tea (or slightly less herbal wine) and tackling things one step at a time. If you feel a passive aggressive remark coming on, try a compliment instead. E.g. "You're so good looking."

This 2-step assembly should take around 10 minutes with an Allen key.

Designed for everyday

## Component Hardware

Please check you have all the fittings  
part or tools are listed in below.

**No. A**  
Quantity:1 Pc  
**Nut**  
M6\*18

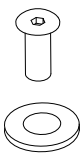

**No. B**  
Quantity:1 Pc  
**Screw Bolt**  
M6\*469

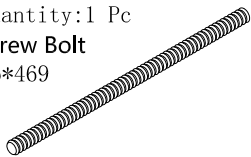

**No. C**  
Quantity:1 Pc  
**Key**  
4mm



**No. D**  
Quantity:1 Pair  
**Gloves**



**No. E**  
Quantity:4 Pcs  
**EVA Pad**  
φ 25mm



## Component Panels & part List

Please check you have all the panels  
are listed below.

1. Top Glass-----x1 CTN 2/2
2. Leg-----x1 CTN 1/2

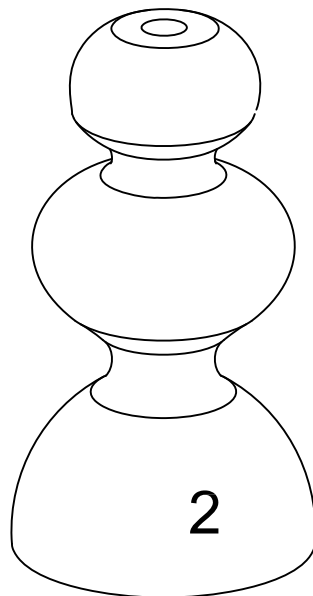
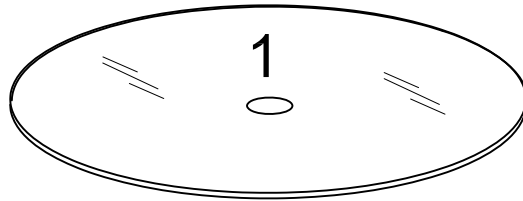

# STEP 1

Lay a soft matt down to protect the furniture piece before and during assembly.

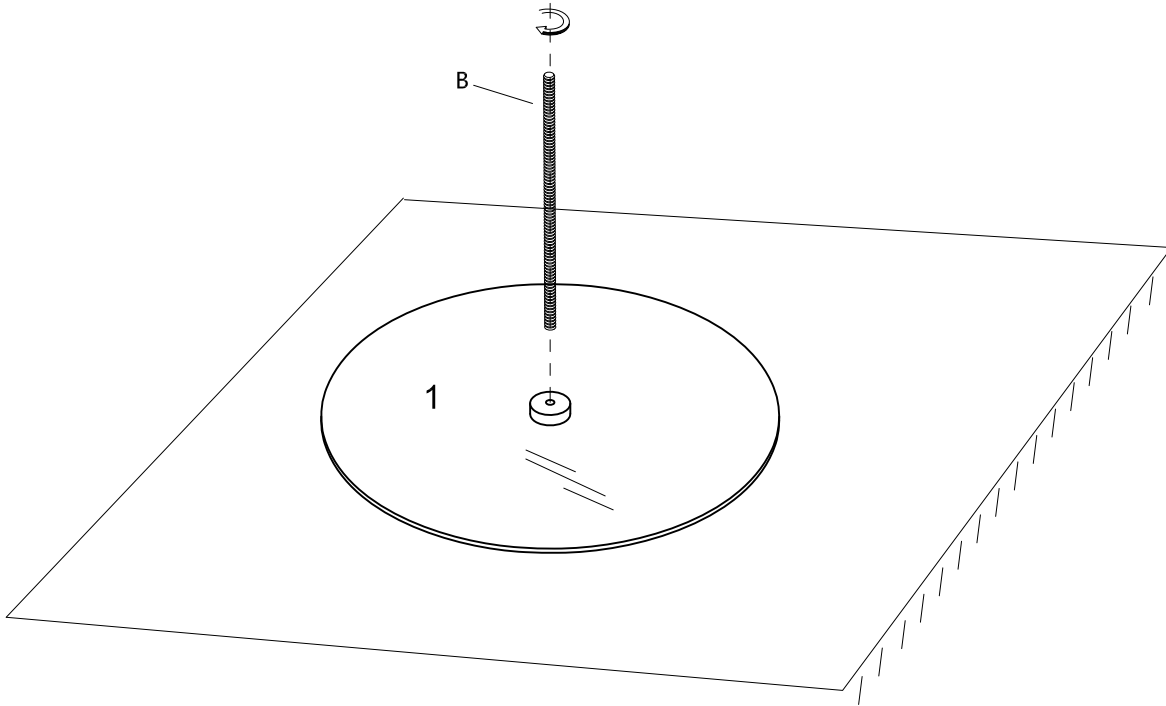

No. B  
Quantity:1 Pc

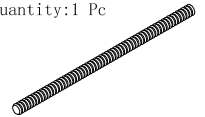

# STEP 2

Hold the base to prevent from rotation when tighten the screw otherwise may scratch the surface of the base.

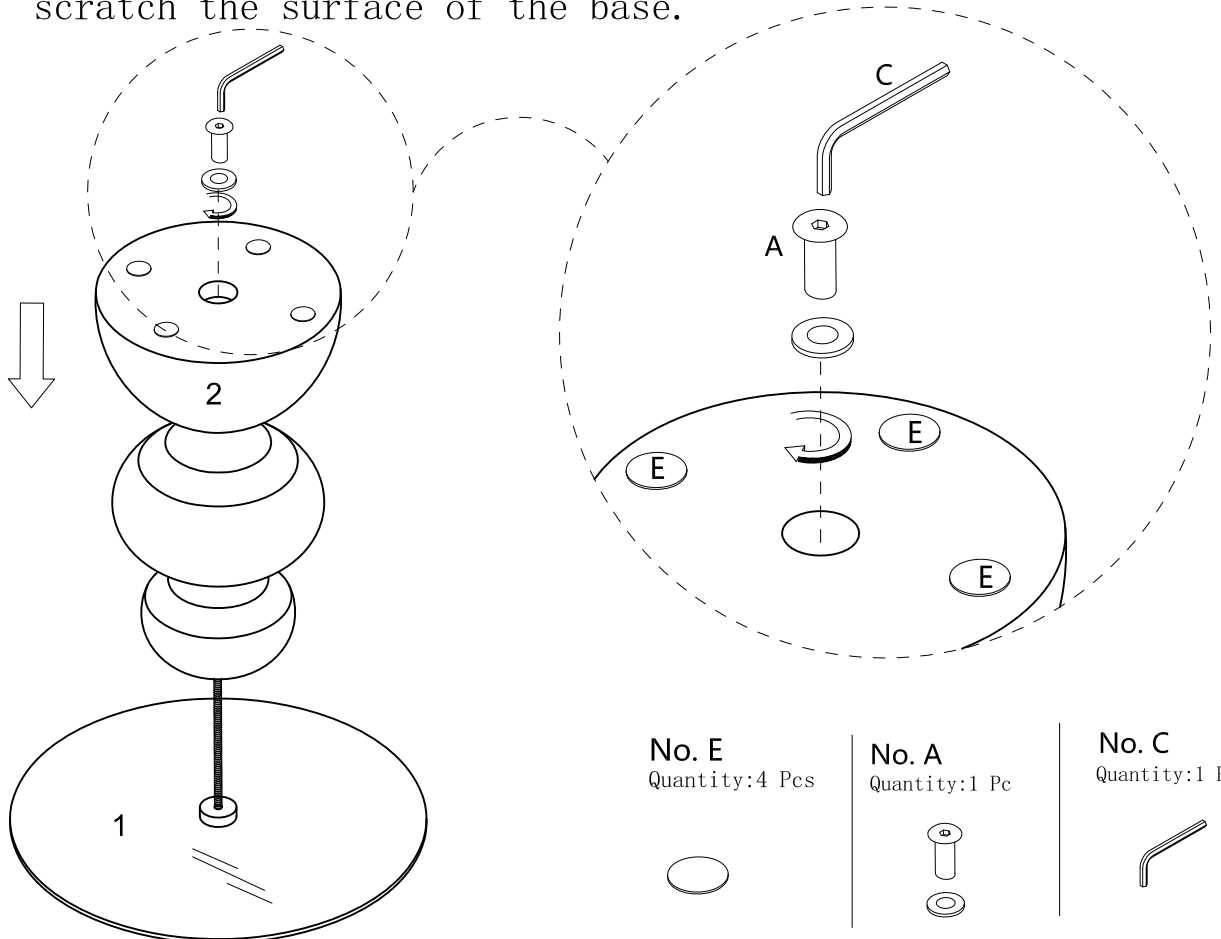

No. E  
Quantity:4 Pcs



No. A  
Quantity:1 Pc



No. C  
Quantity:1 Pc



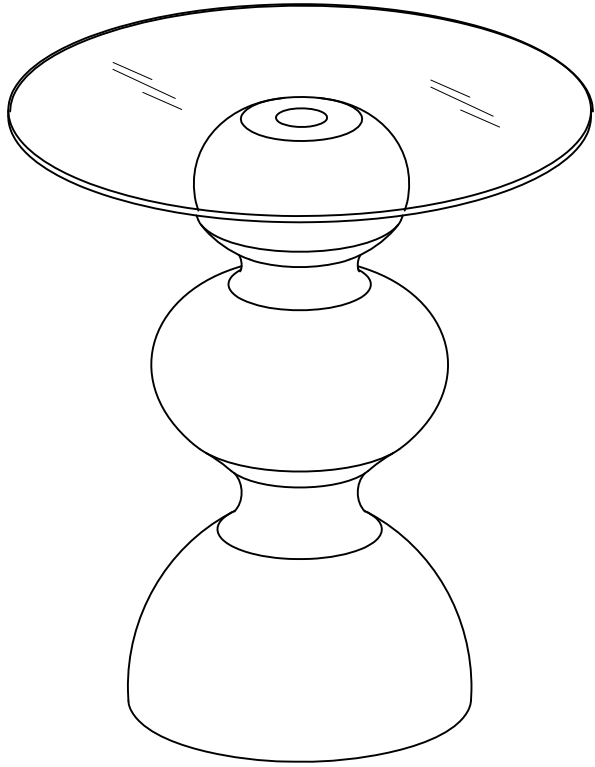

lifely.com.au

Great job. You're done!

Don't forget to share how it looks in  
your space and tag us on Instagram.

@lifelyhome #homewithlifely!