

Assembly Instruction

Tyron Series

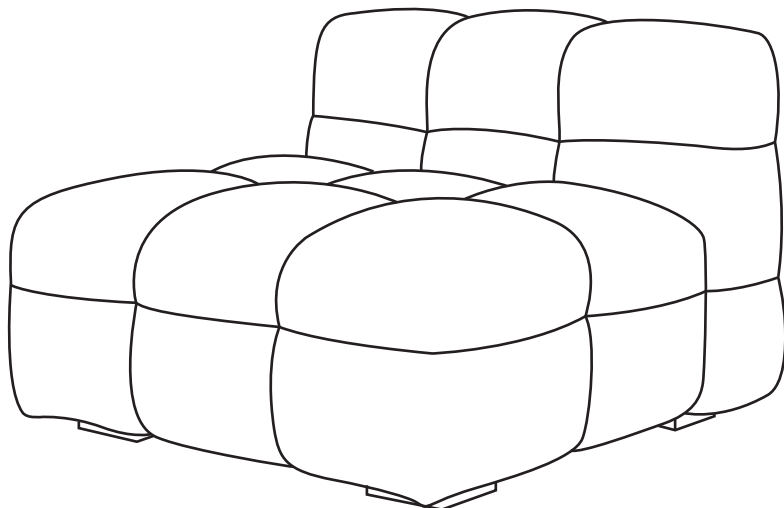

Lifely*

Product Code

Tyron Armchair

Dimensions (W x D x H)

960mmX 1050mmX 680mm

Important

Please read through instruction carefully before assembly and keep for future reference.

For our full catalogue of assembly instructions, visit: lifely.com.au/assembly.

Important Tips and Maintenance



1. Keep children and animals away from working area as smaller parts may cause choking if swallowed.



2. Never place liquids or anything damp upon furniture as it will mark. Ensure a coaster or running is beneath.



3. Never use ammonia based cleaning products as it will damage the finish.

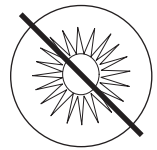

4. To avoid fading, keep furniture out of direct sunlight.



5. Use a soft or damp cloth (dry cloth) when wiping or cleaning surfaces.

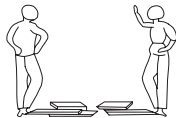

6. Two person are required.

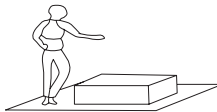

7. Lay a soft matt down to protect the furniture piece before and during assembly.

So your relationship is strong. But is it flat-pack furniture strong? Unless you're an aerospace engineer, assembling furniture can be slightly stressful. We recommend meditating quietly, pouring yourself a herbal tea (or slightly less herbal wine) and tackling things one step at a time. If you feel a passive aggressive remark coming on, try a compliment instead. E.g. "You're so good looking."

This 3-step assembly should take around 18 minutes with an Allen Key- or 12 minutes with an electric drill.
Godspeed.

Designed for everyday

Component Hardware

Please check you have all the fittings
part or tools are listed in below.

No. A

Quantity: 4 Pcs

Screw

M8x 35mm



No. B

Quantity: 1 Pc

Allen Key



No. C

Quantity: 4 Pcs

L-shaped legs

165x 45x 33mm



No. D

Quantity: 2 Pcs

Legs

H30mm



No. F

Quantity: 14 Pcs

Bolt

M5x 40mm



Component Panels & Part List

Please check you have all the panels
are listed below.

1. The back of the sofax1
2. The seat of the sofax1
3. Hardwarex1

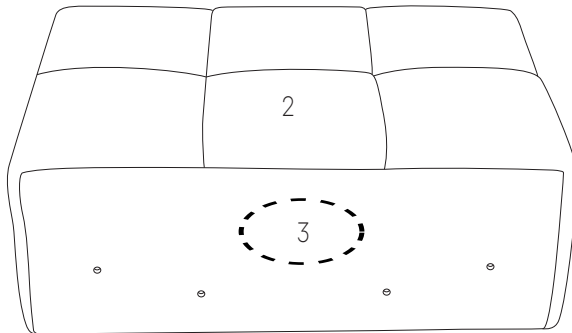
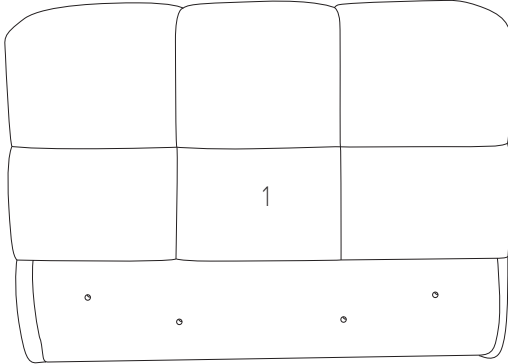

Step1 : Screw all the screws 80% by hand, please do adjustment to ensure the back and seat are aligned, then tighten by Allen Key fully.

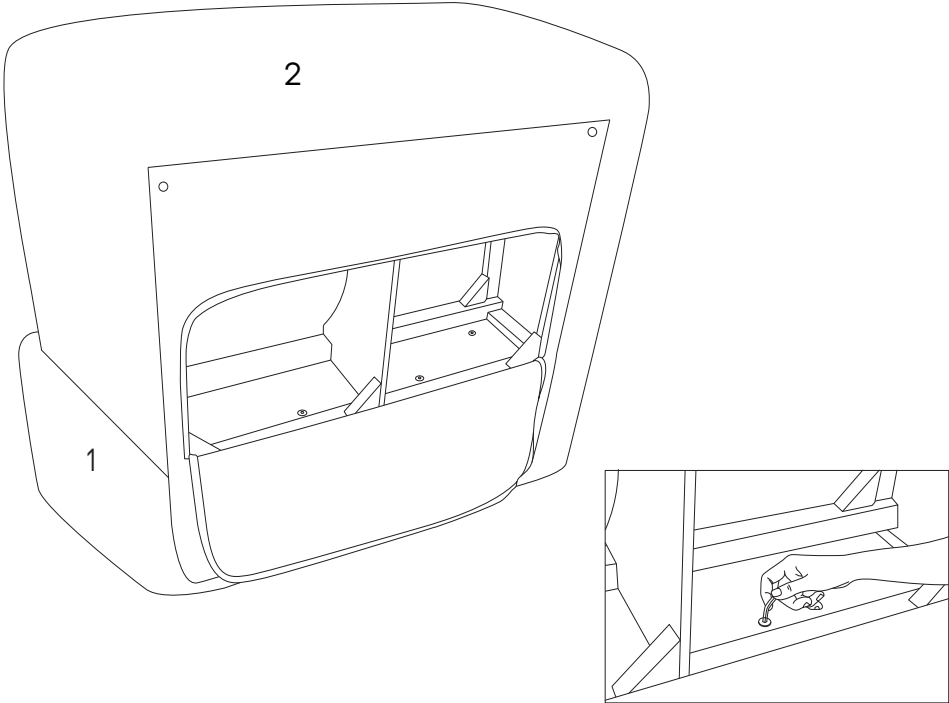

No. A
Quantity: 4 Pcs
Screw
M8x 35mm



No. B
Quantity: 1 Pc
Allen Key



Step 2: Fix L-shaped legs with screws (prepare tools by yourself).

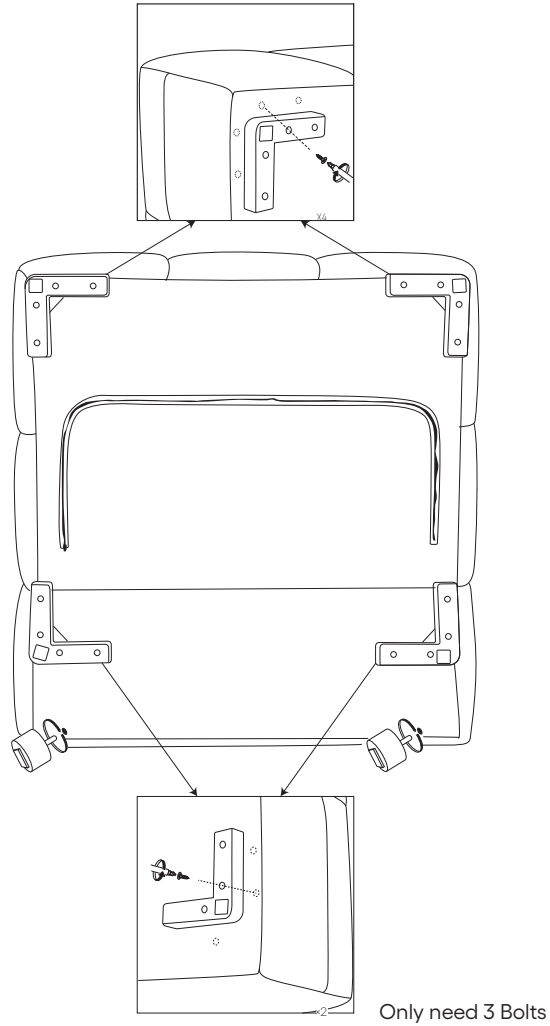

No. C

Quantity: 4 Pcs

L-shaped legs

165x 45x 33mm



No. F

Quantity: 14 Pcs

Bolt

M5x 40mm



No. D

Quantity: 2 Pcs

Legs

H30mm



Step 3:

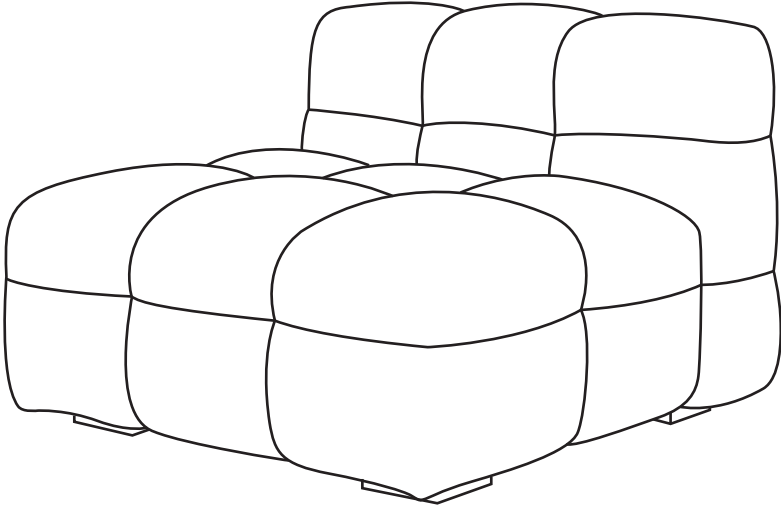

Great job. You're done!

Don't forget to share how it looks in
your space and tag us on Instagram.

@lifelyhome#homewithlifely!