

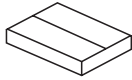

Kave® Cares



15 min



x1



x1

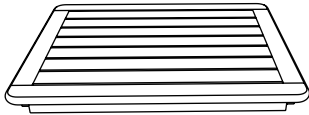

**A** x1



**B** x4



**C** x8



**D** x8



**E** x1

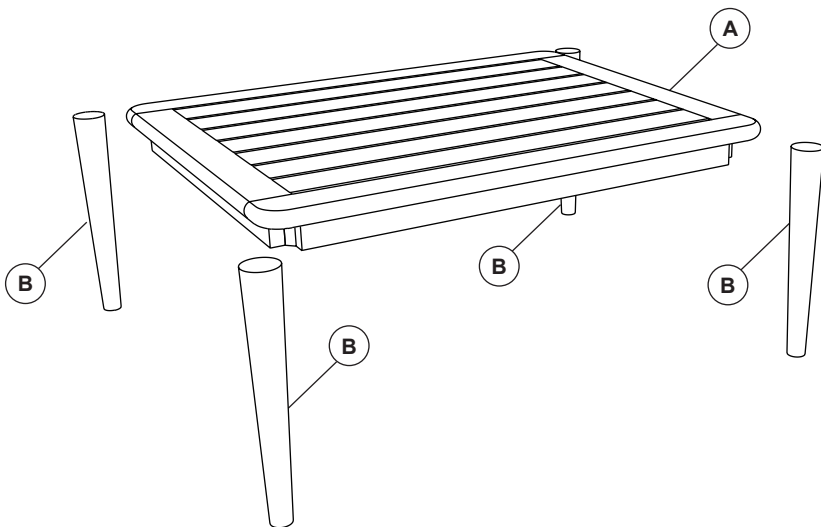

1

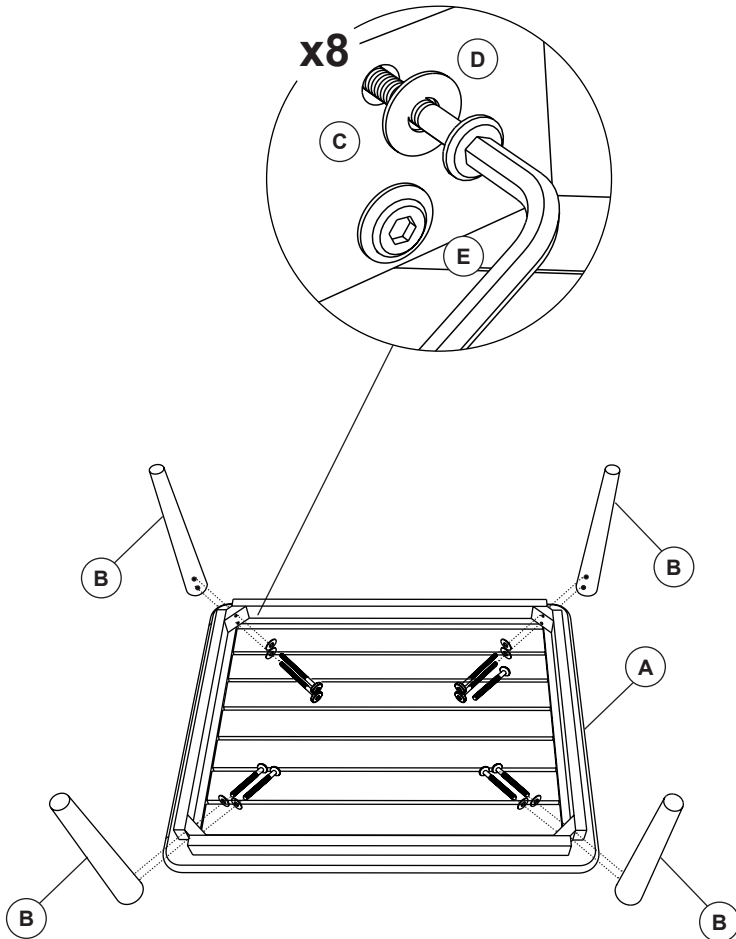

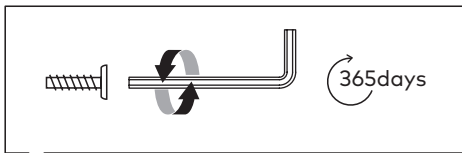
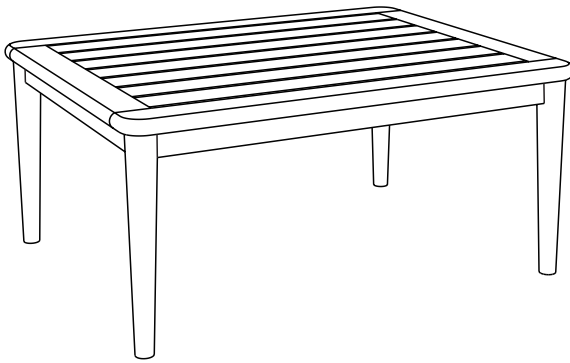





**THAT'S ALL FOLKS**

Share your style!

#KaveHome

