

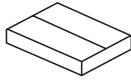

Kave® Cares



20 min



x1



x1

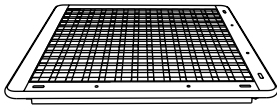

A x1



B x4



C x1



D x14



E x8

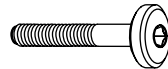

F x3



G x1



H x2

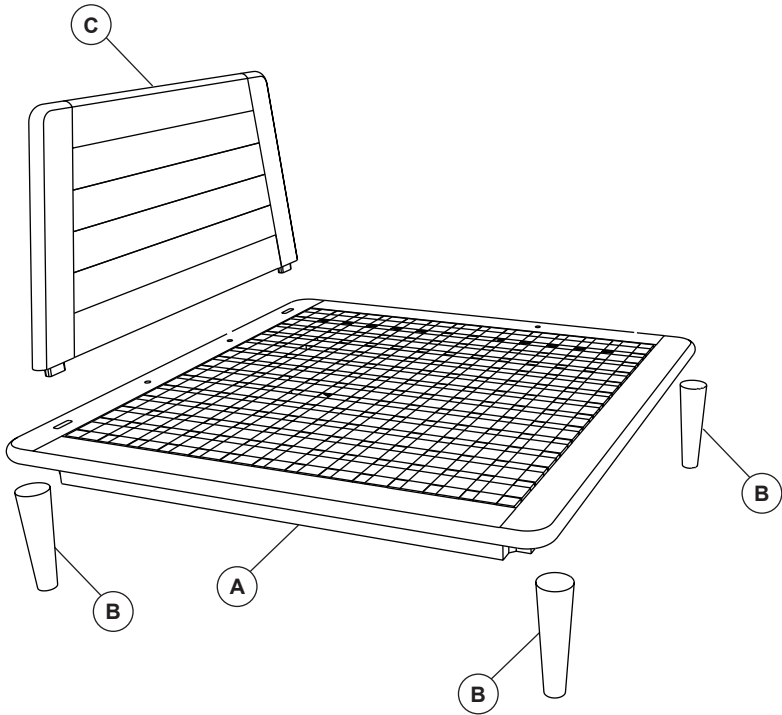

1

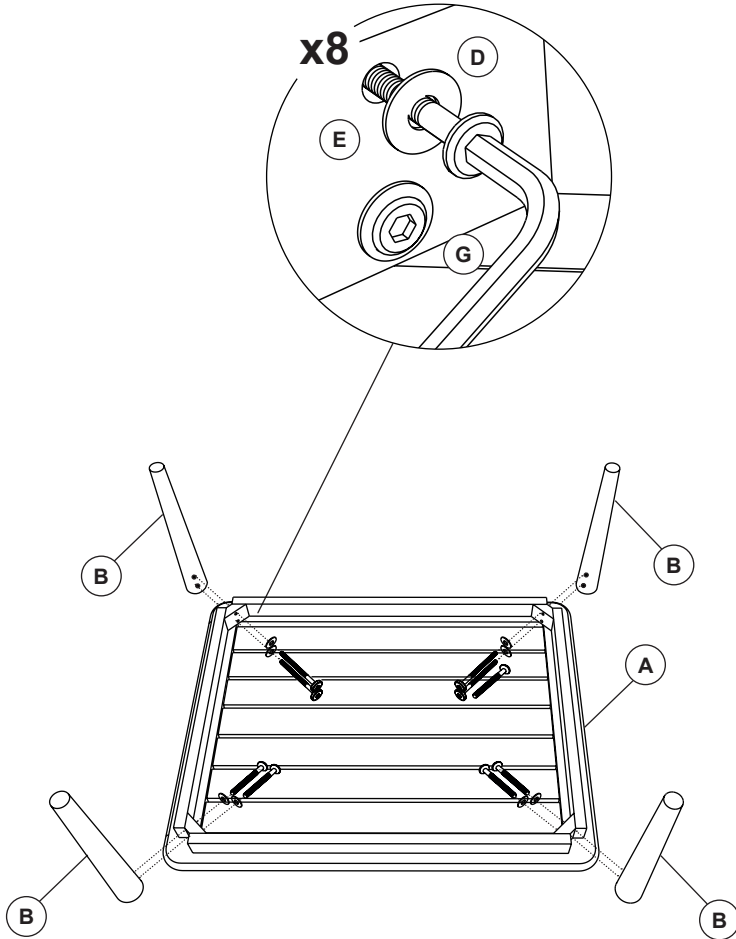

2

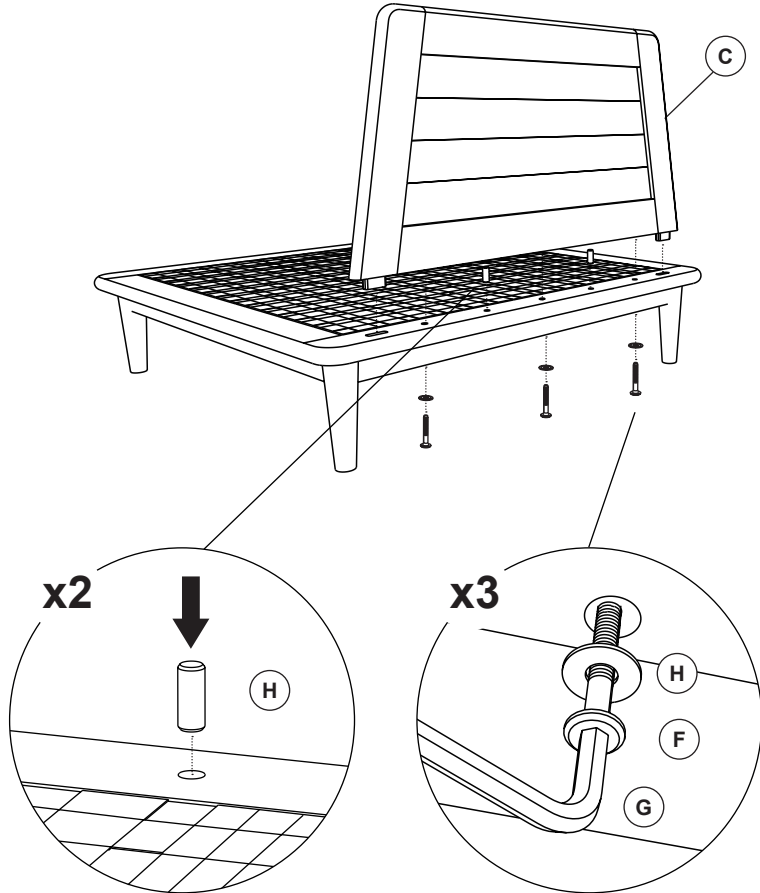

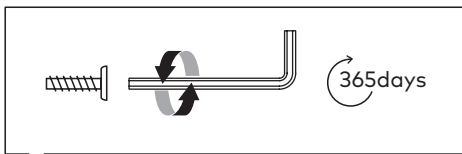
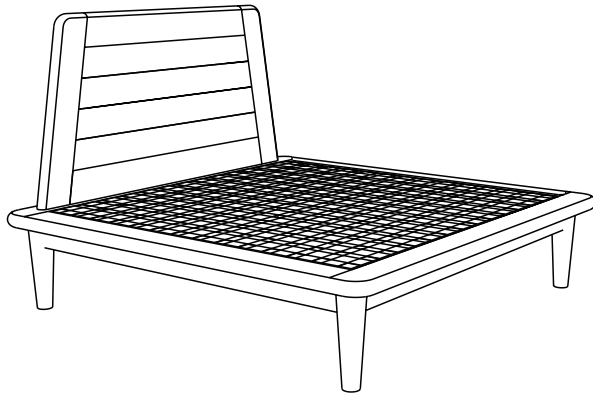



THAT'S ALL FOLKS

Share your style!

#KaveHome

