



Kave® Cares



20 min



x1



x2

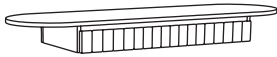

**A** x1



**B** x1



**C** x2



**D** x8  
8x22mm

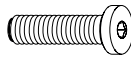

**E** x8  
8x40mm

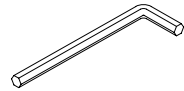

**F** x1

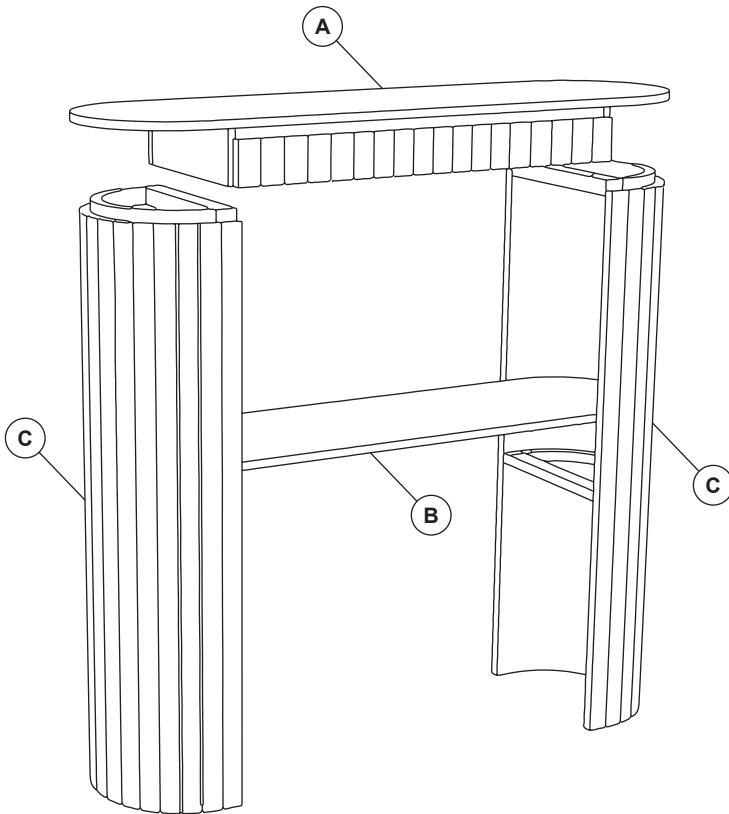

1

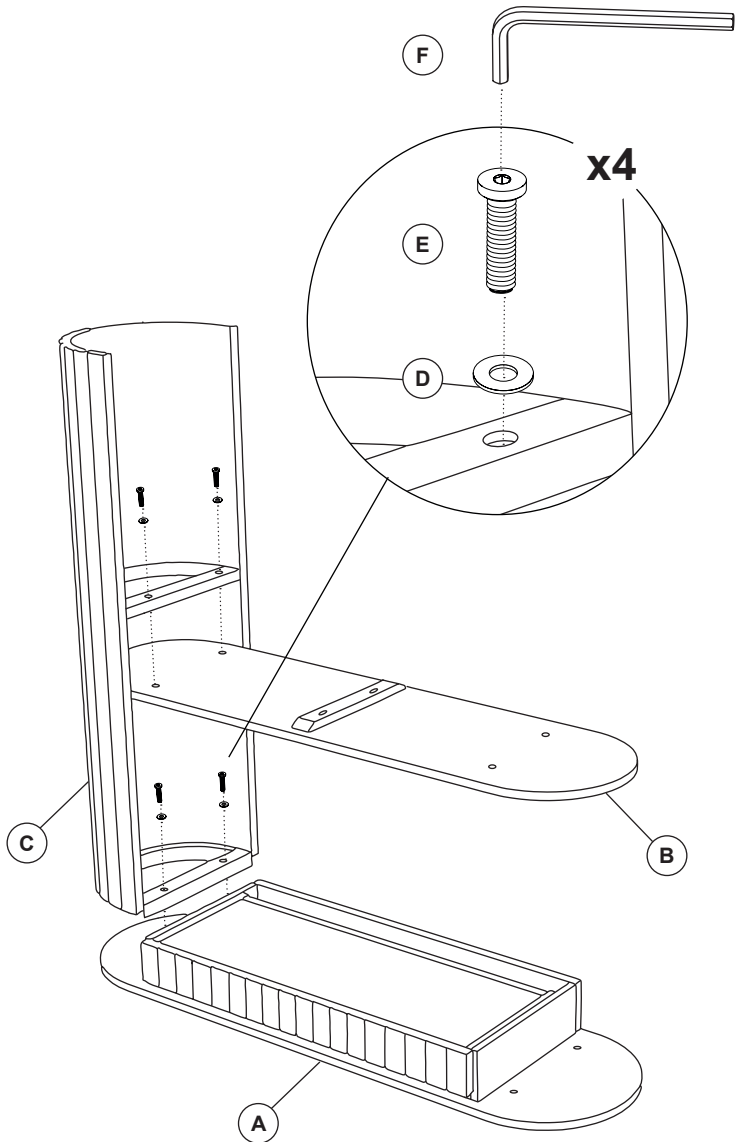

2

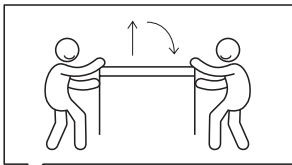
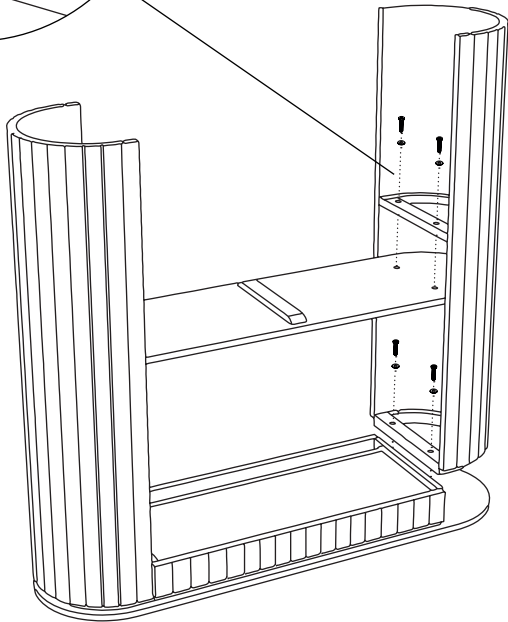
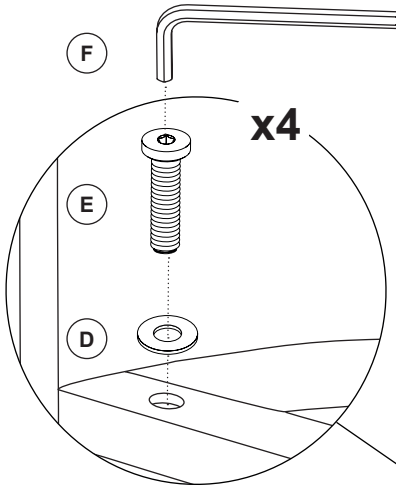

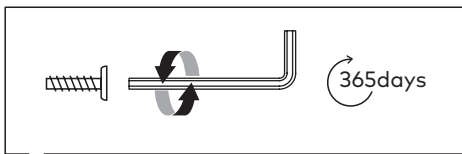
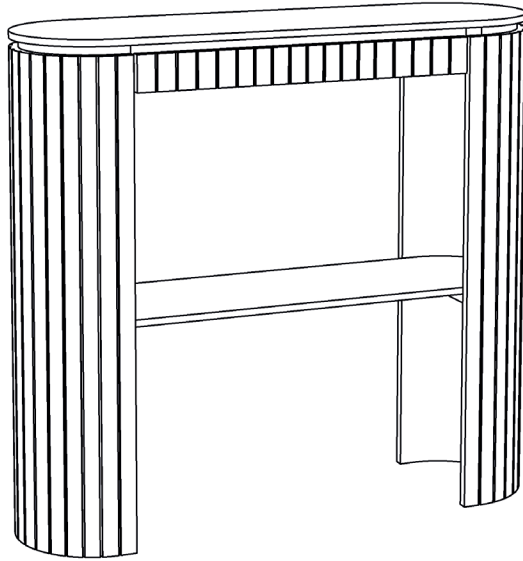



**THAT'S ALL FOLKS**

Share your style!

#KaveHome

