

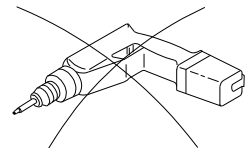

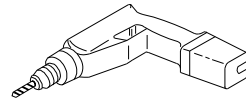

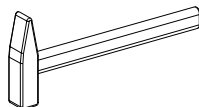

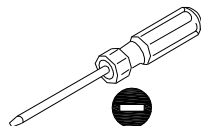

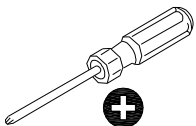
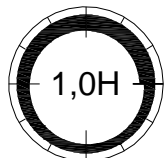
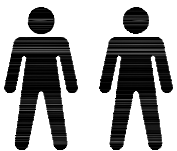
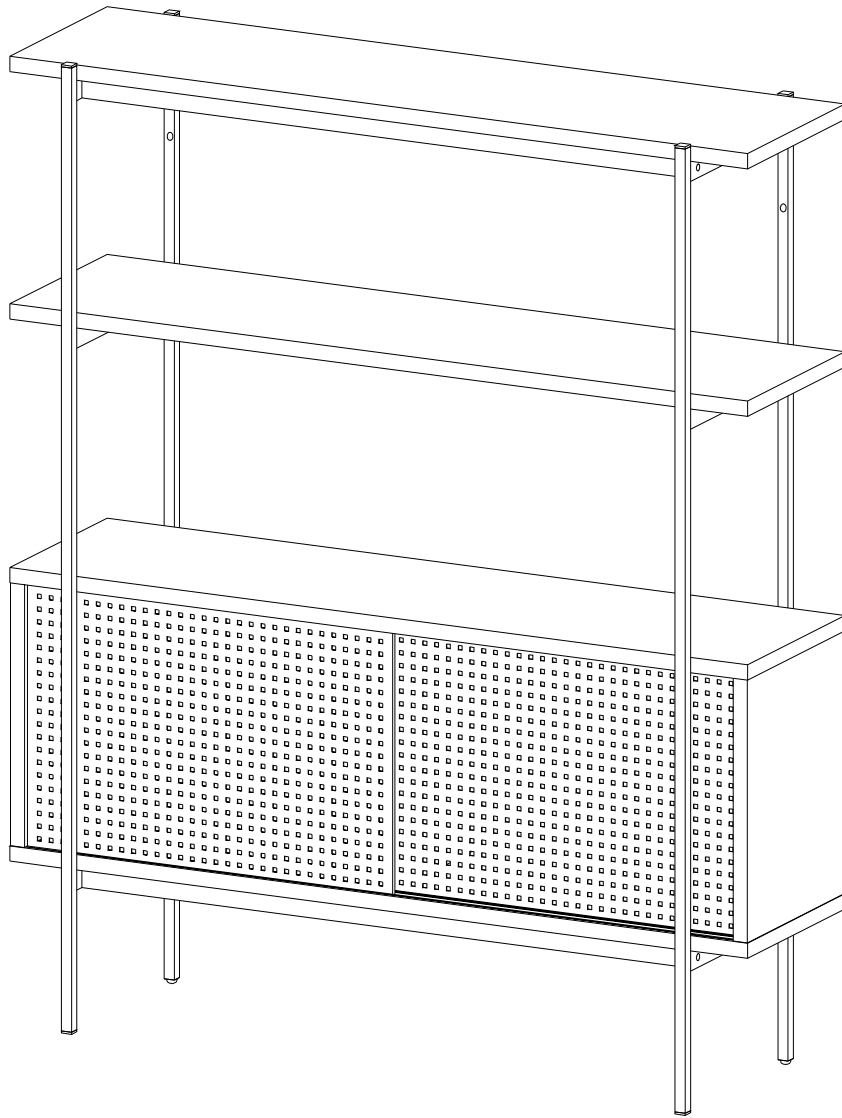
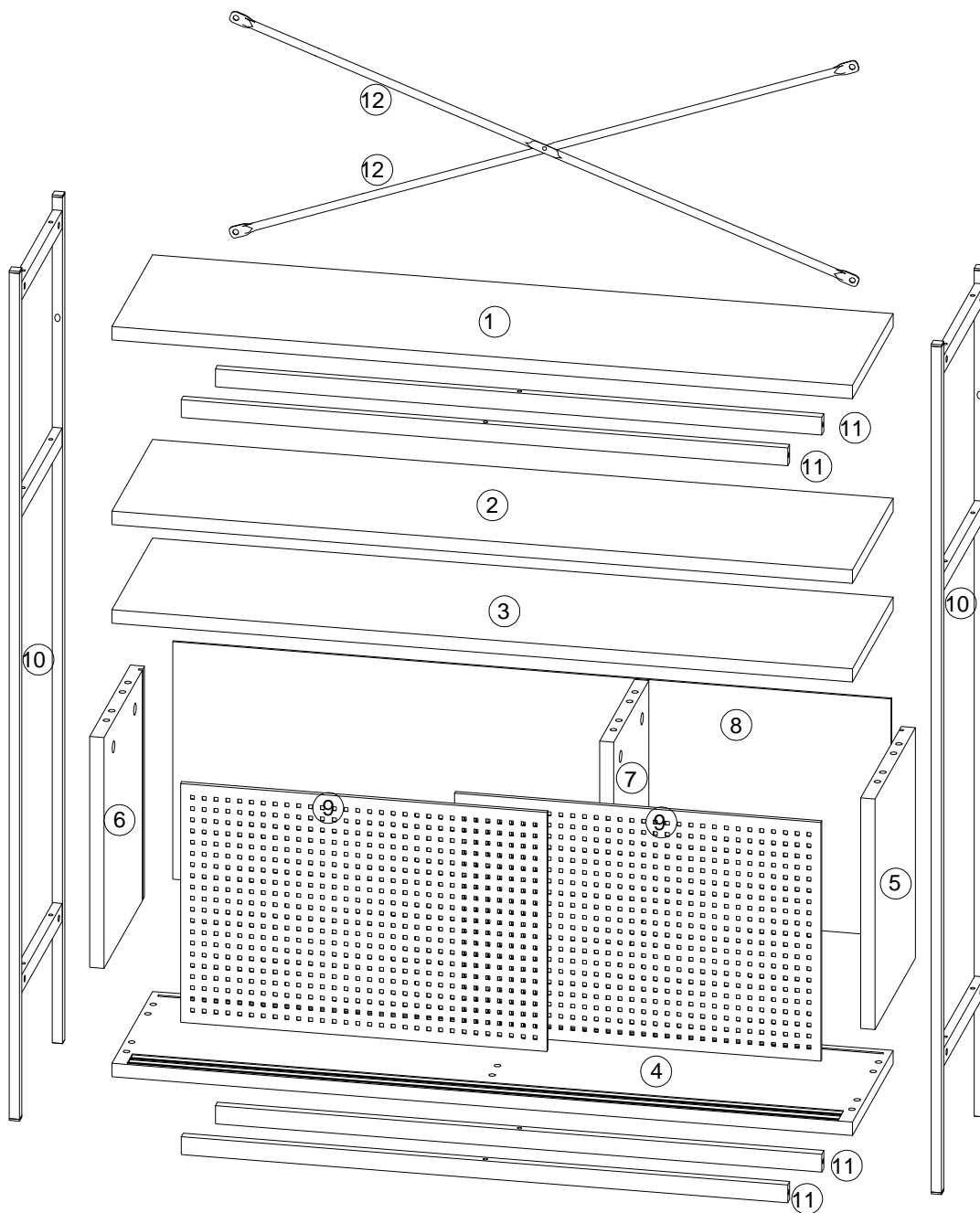



# Angus

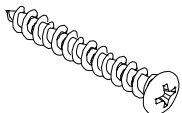

29/05/2021

			✓				✓
①	1	940x242x18		②	1	940x242x18	
③	1	940x242x18		④	1	940x242x18	
⑤	1	309x241x18		⑥	1	309x241x18	
⑦	1	309x193x18		⑧	1	911x318x2.75	
⑨	2	465x320x6		⑩	2	1138x270x13	
⑪	4	770x24x12		⑫	2	845xØ10	

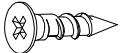

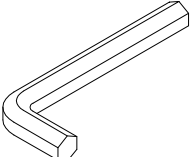
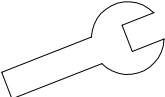
<p>A x 8</p>  <p>M6×30mm</p>	<p>B x 4</p>  <p>M6×10mm</p>	<p>C x 1</p>  <p>M6×15mm</p>	<p>D x 1</p>  <p>M6</p>
<p>E x 16</p>  <p>4×35mm</p>	<p>F x 6</p>  <p>6.3×45mm</p>	<p>G x 6</p>  <p>Ø15×12mm</p>	<p>H x 12</p>  <p>Ø8×30mm</p>
<p>J x 6</p>  <p>7×48mm</p>	<p>K x 6</p>  <p>Ø20</p>	<p>L x 2</p>  <p>Ø13×6mm</p>	<p>M x 6</p>  <p>3.5×16mm</p>
<p>N x 6</p>  <p>9×9×14mm</p>	<p>P x 1</p>  <p>4mm</p>	<p>Q x 1</p>  <p>M6</p>	



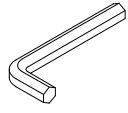
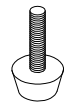

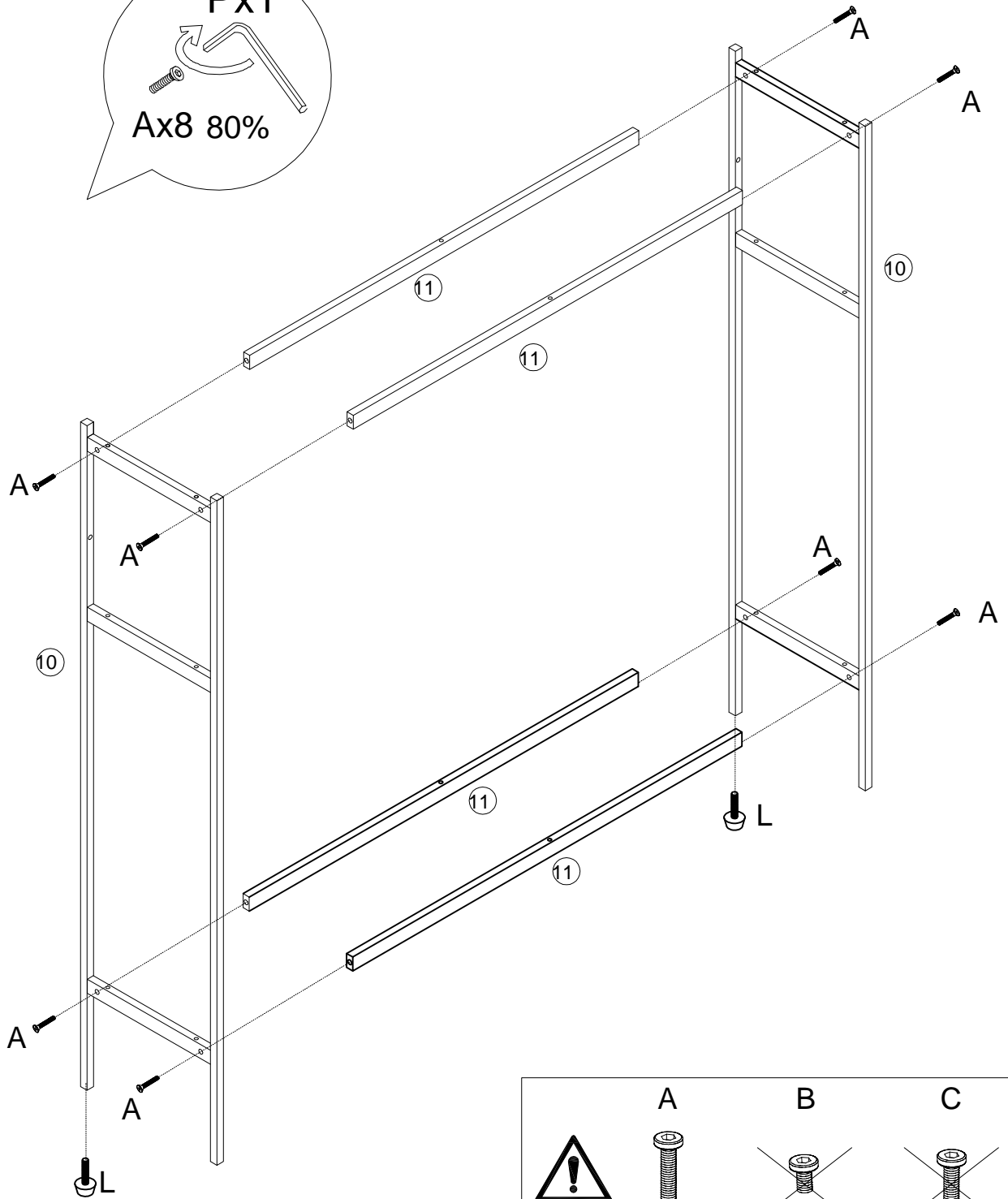
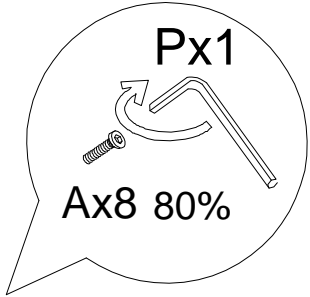
1

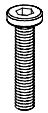
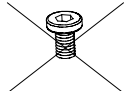
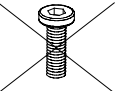
A x 8  M6x30mm	P x 1  4mm	L x 2  Ø13x6mm
---	---	---



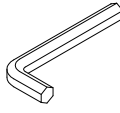

	A  M6x30mm	B  M6x10mm	C  M6x15mm
---	---	---	---

# 2

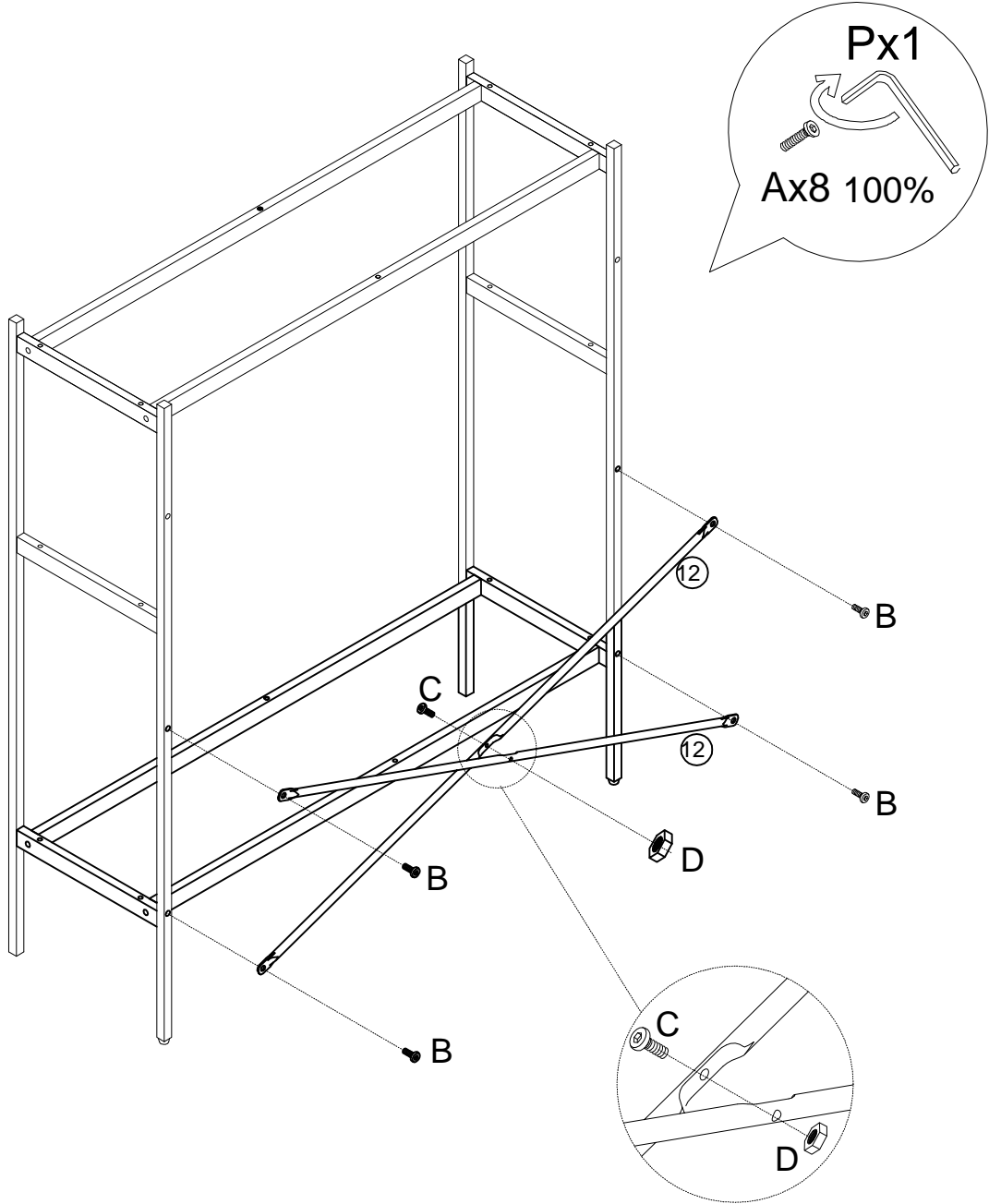
B x 4  M6x10mm	C x 1  M6x15mm	D x 1  M6	P x 1  4mm	Q x 1  M6
---	---	--	--	--

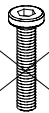

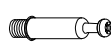

	A  M6x30mm	B  M6x10mm	C  M6x15mm
---	---	---	---

# 3

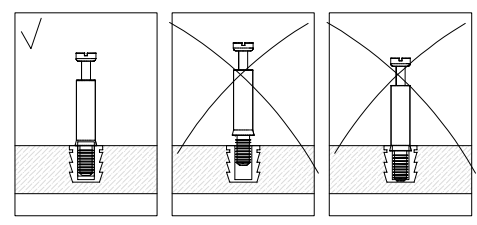
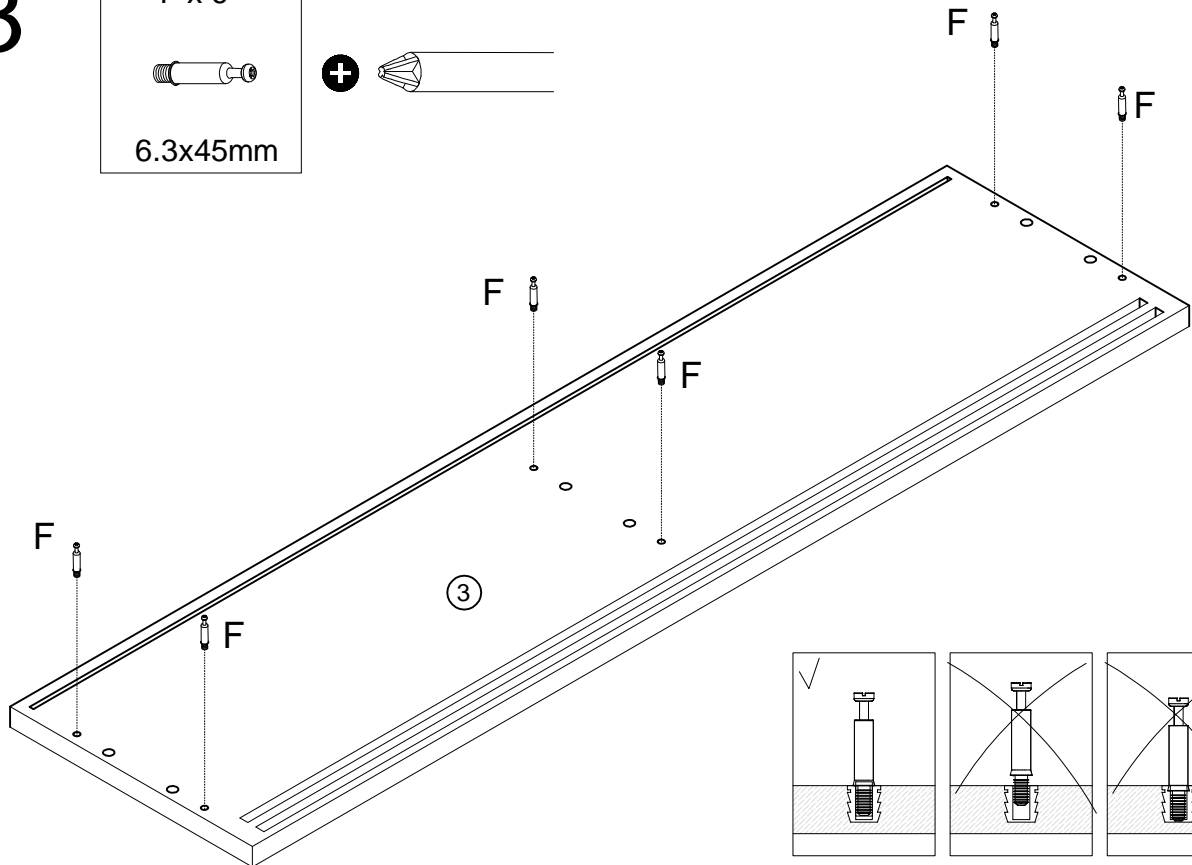
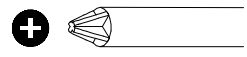
<b>F x 6</b>

<b>6.3x45mm</b>



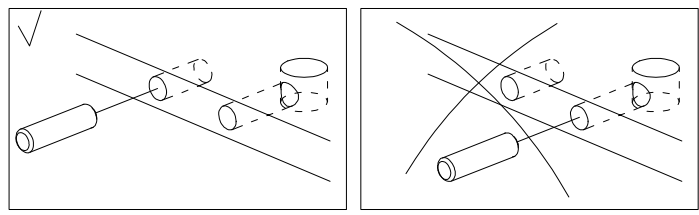
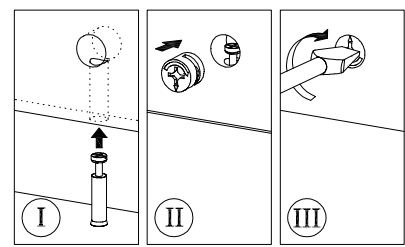
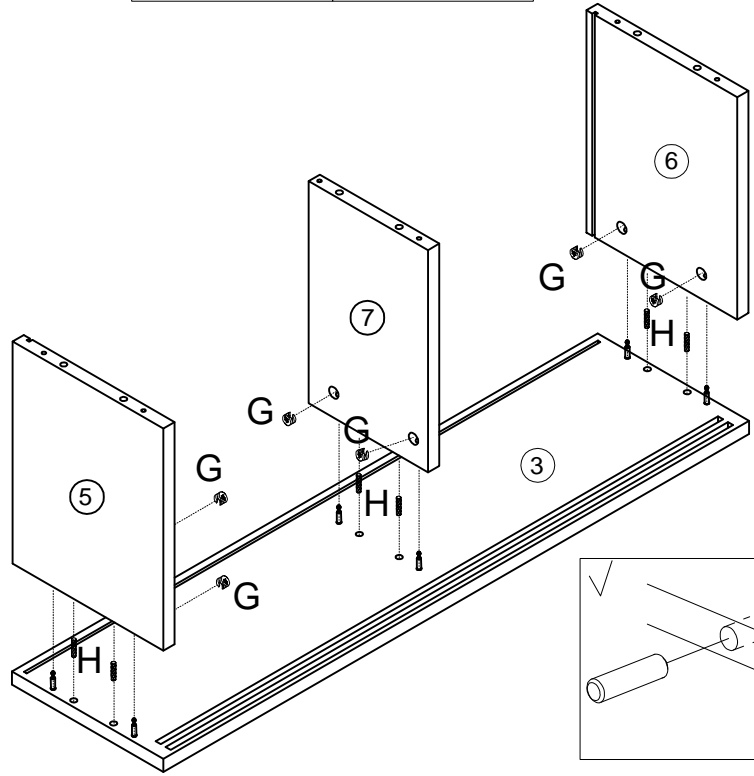
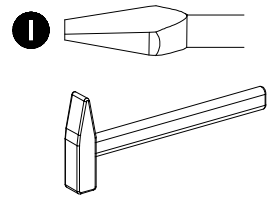

# 4

<b>G x 6</b>	<b>H x 6</b>
	
<b>Ø15x12mm</b>	<b>Ø8x30mm</b>

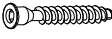
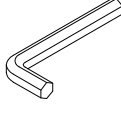

# 5

H x 6  Ø8x30mm	K x 6  Ø20	J x 6  7X48mm	P x 1  4mm
---	---	--	--

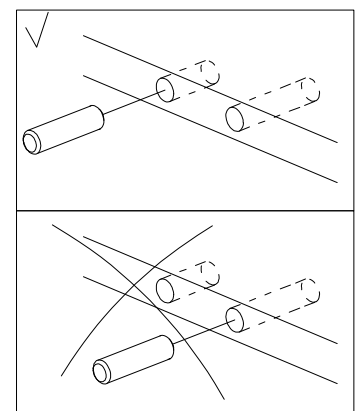
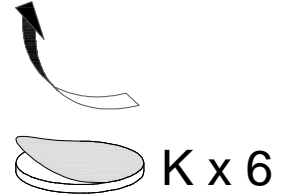
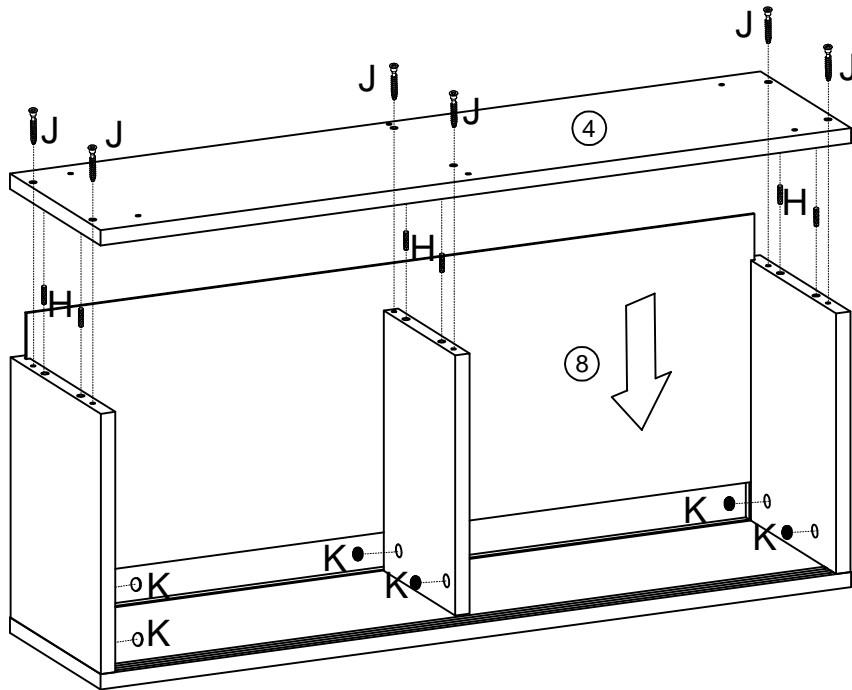
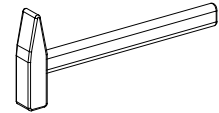

# 6

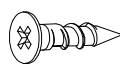
N x 6  9x9x14mm	M x 6  3.5x16mm
--	--

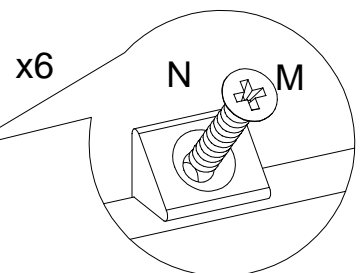
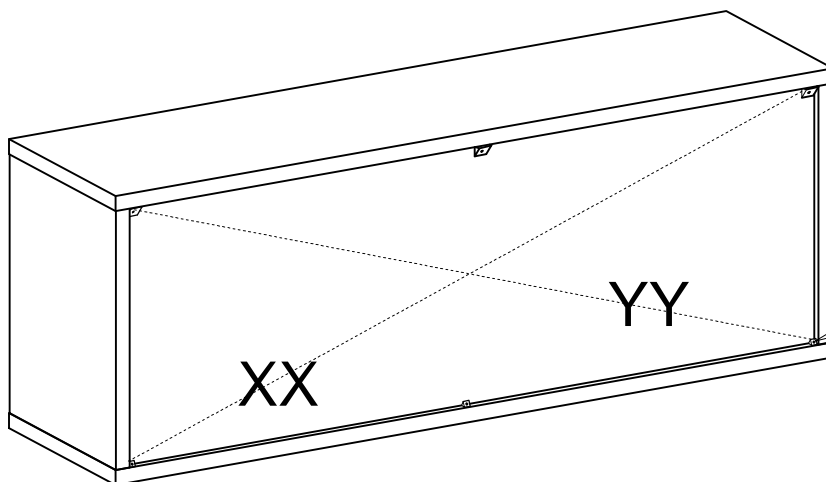
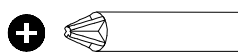

XX=YY

7

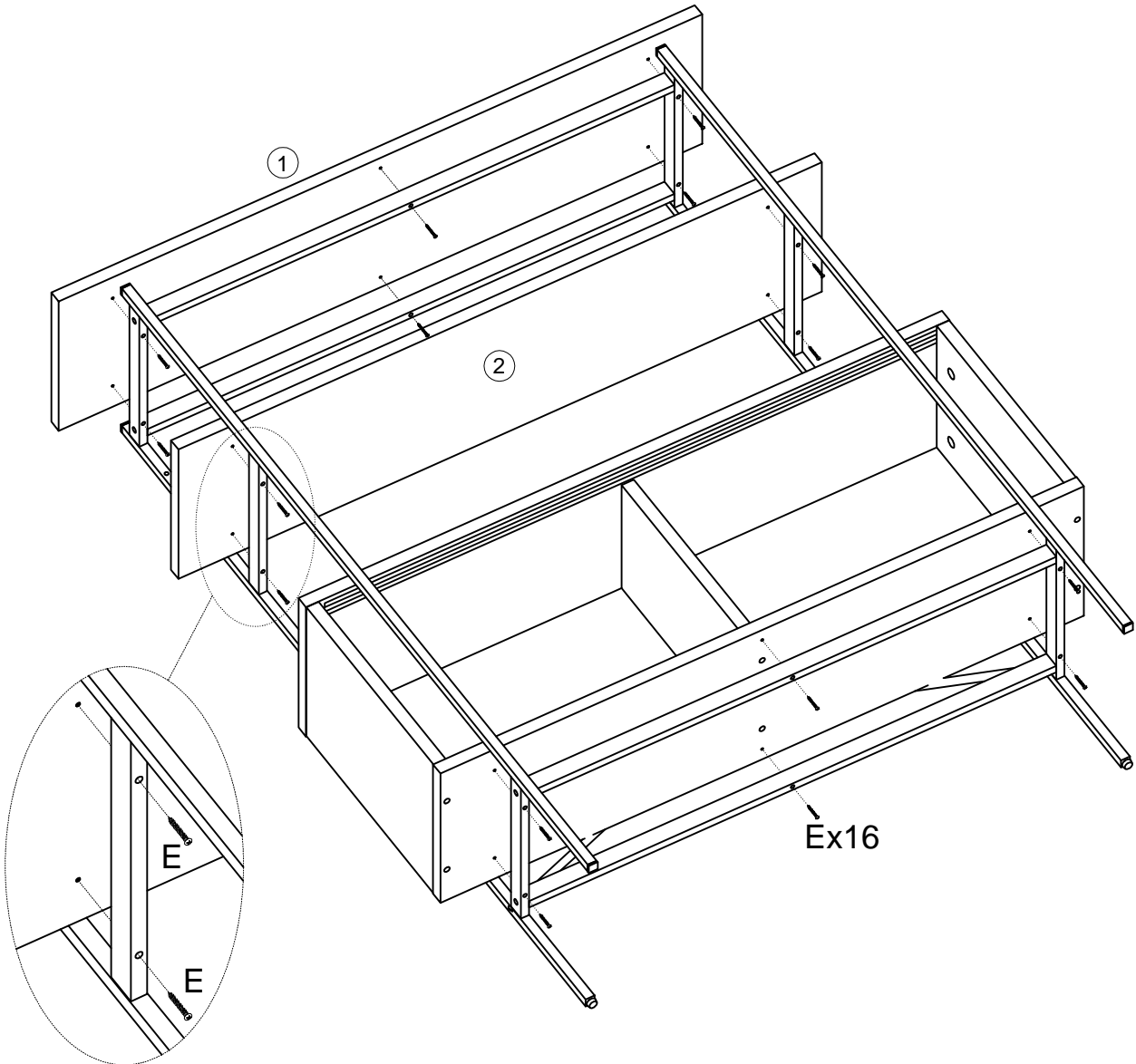
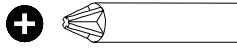
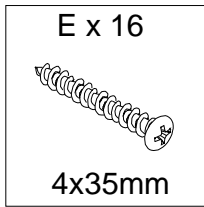



8

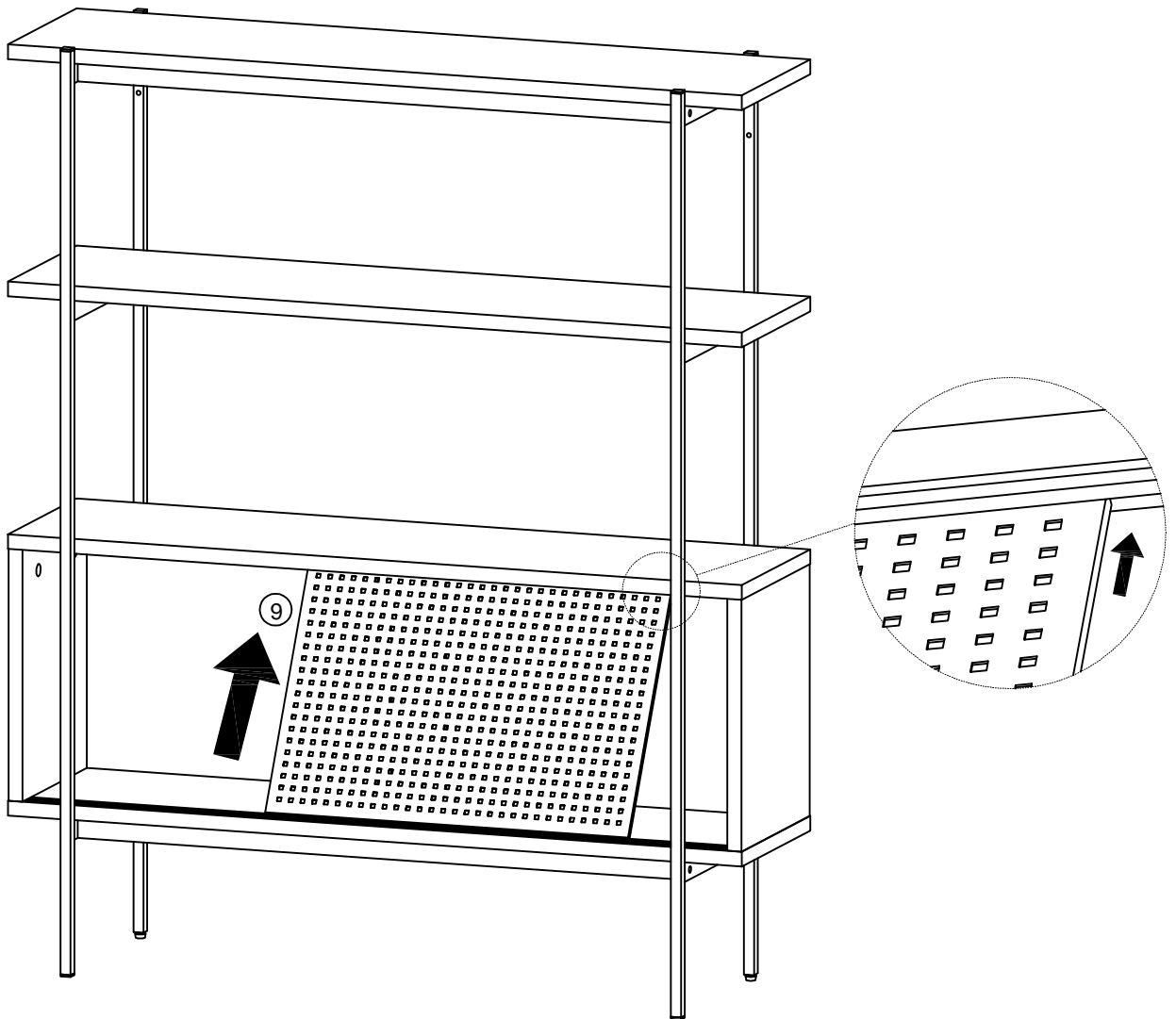

9

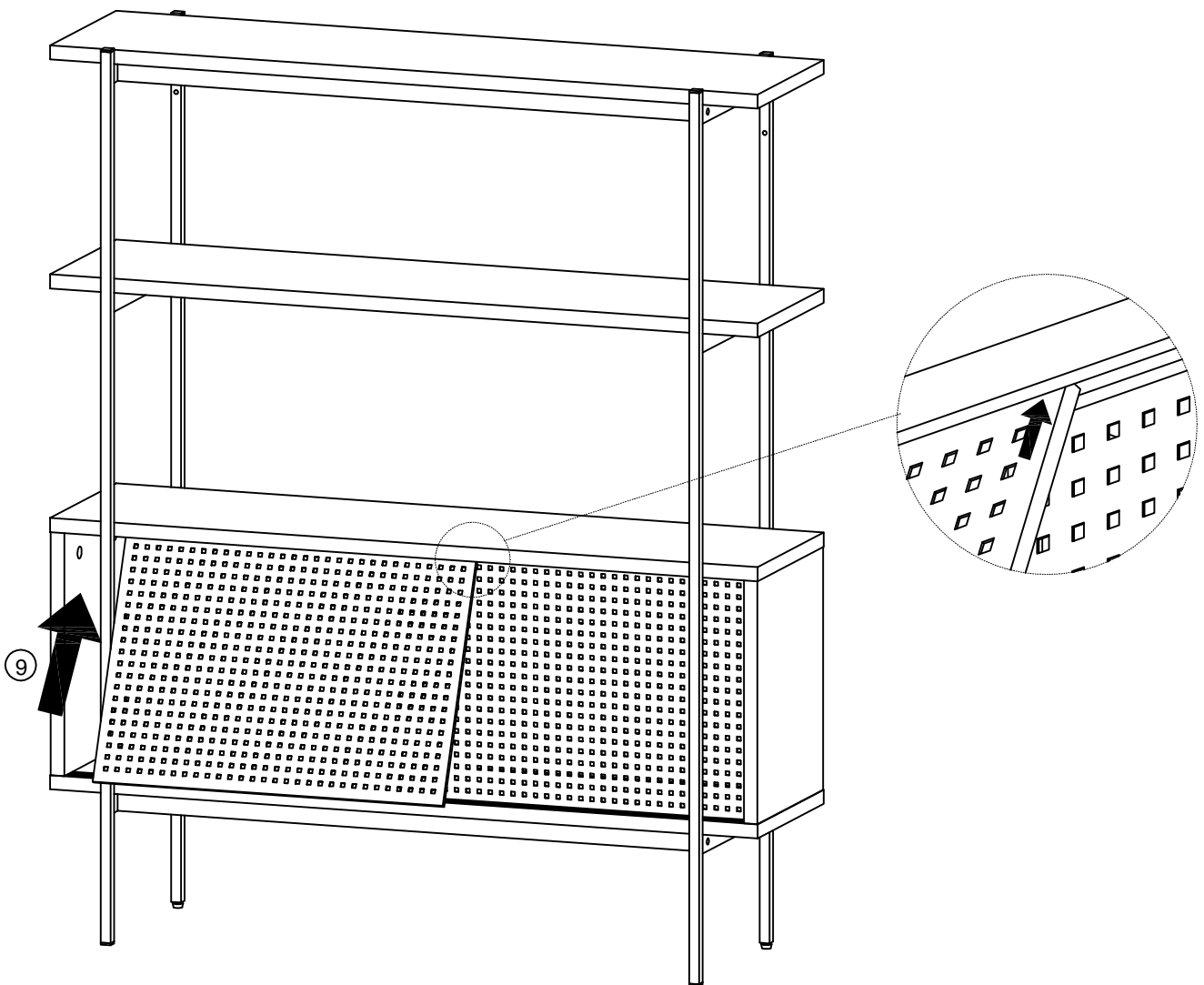

# 10

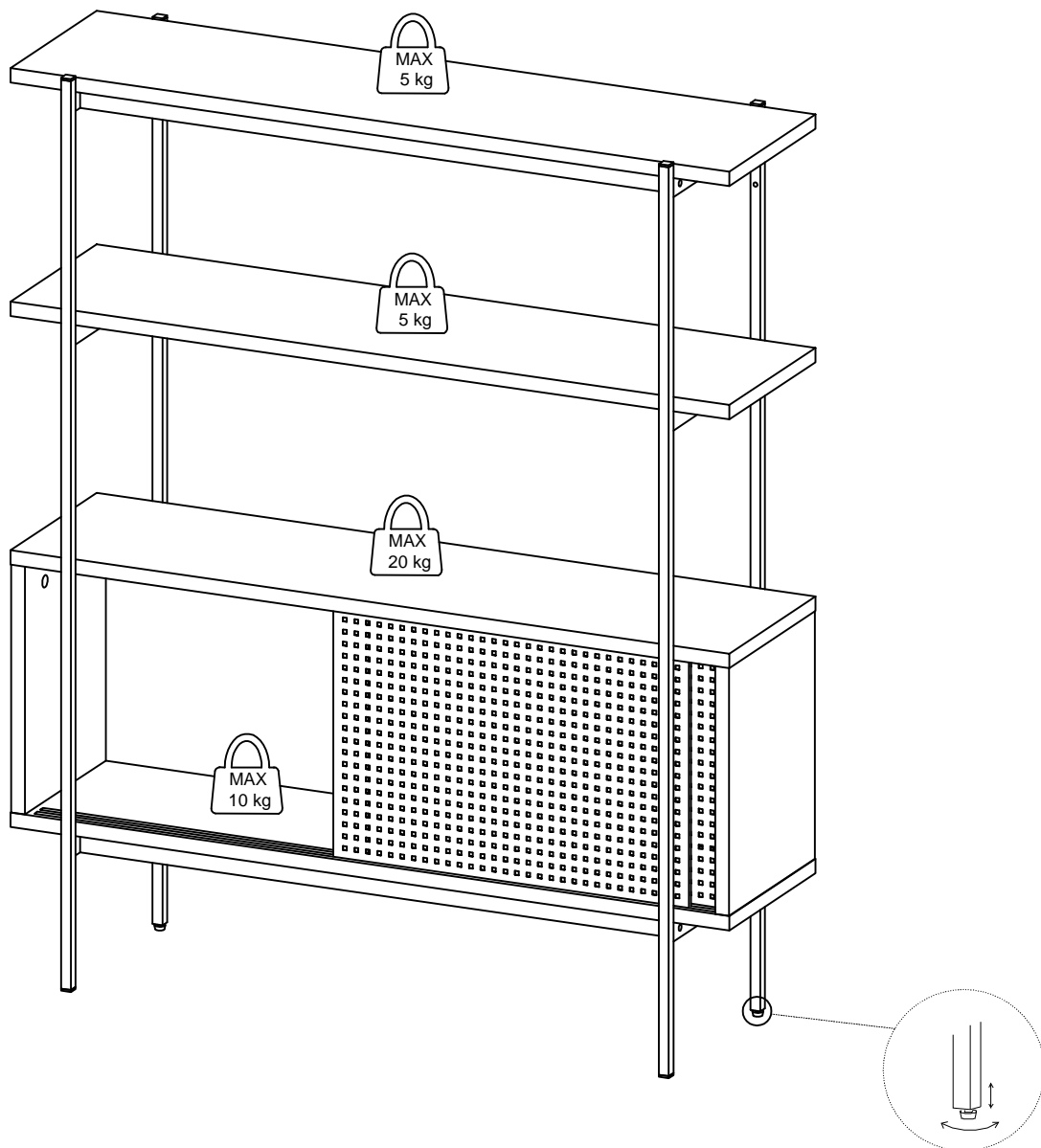

# 11

