

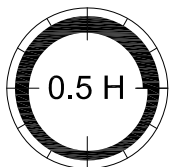

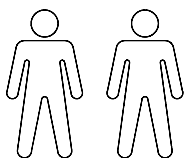

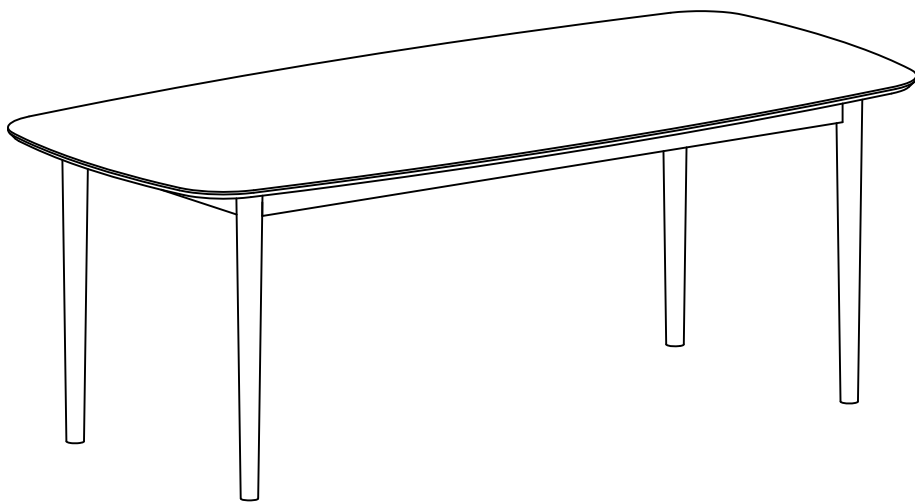

# ASTON

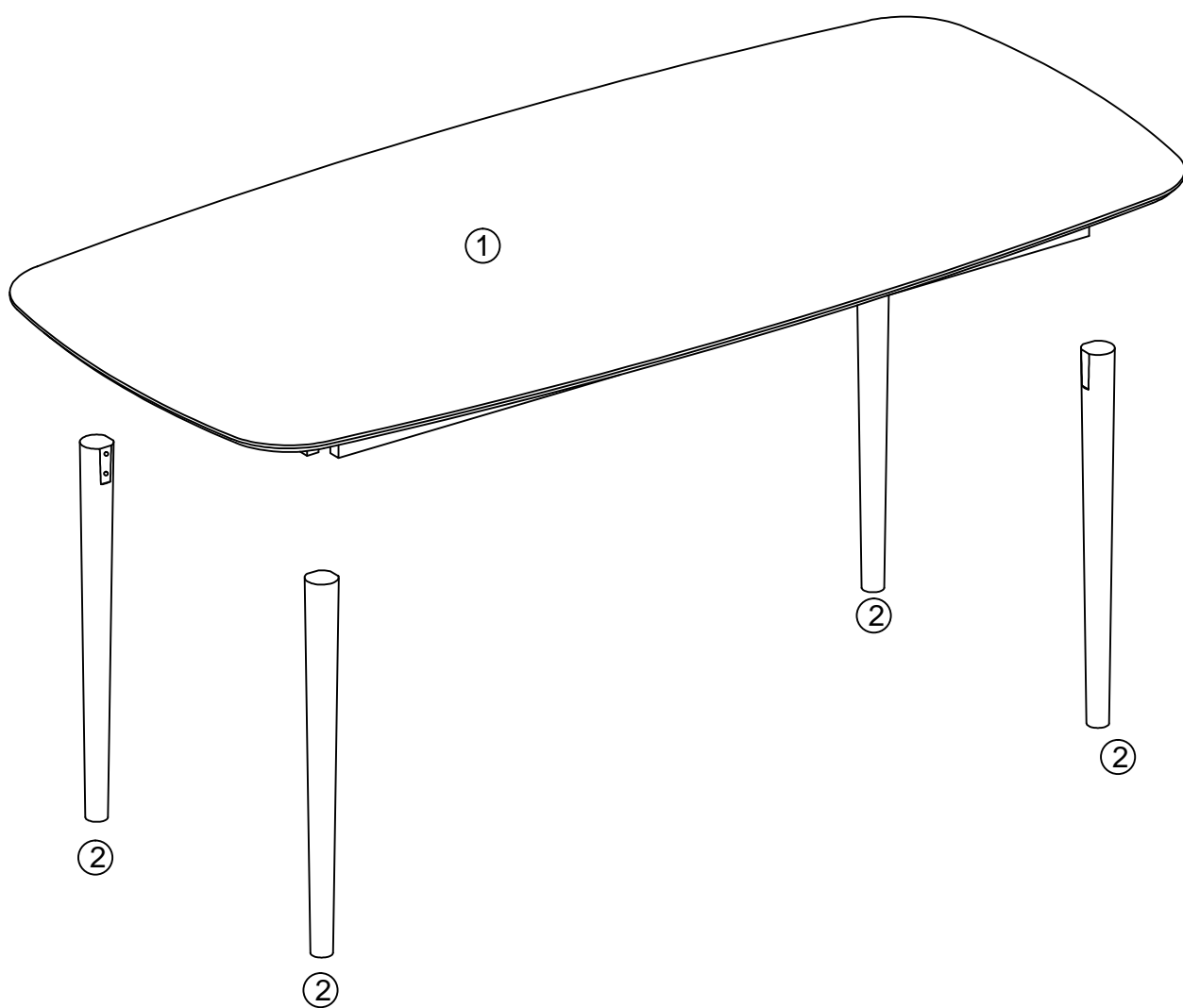





			✓
①	1	2100x1000x89	
②	4	731x $\phi$ 60/ $\phi$ 40	



A x8  M8x80	B x8  M8	C x8  M8/φ19mm	D x1  5mm	E x4  φ35mm
--	---	---	--	--

1

A x8  M8x80	B x8  M8	C x8  M8/φ19mm	D x1  5mm	E x4  φ35mm
--	---	---	--	--

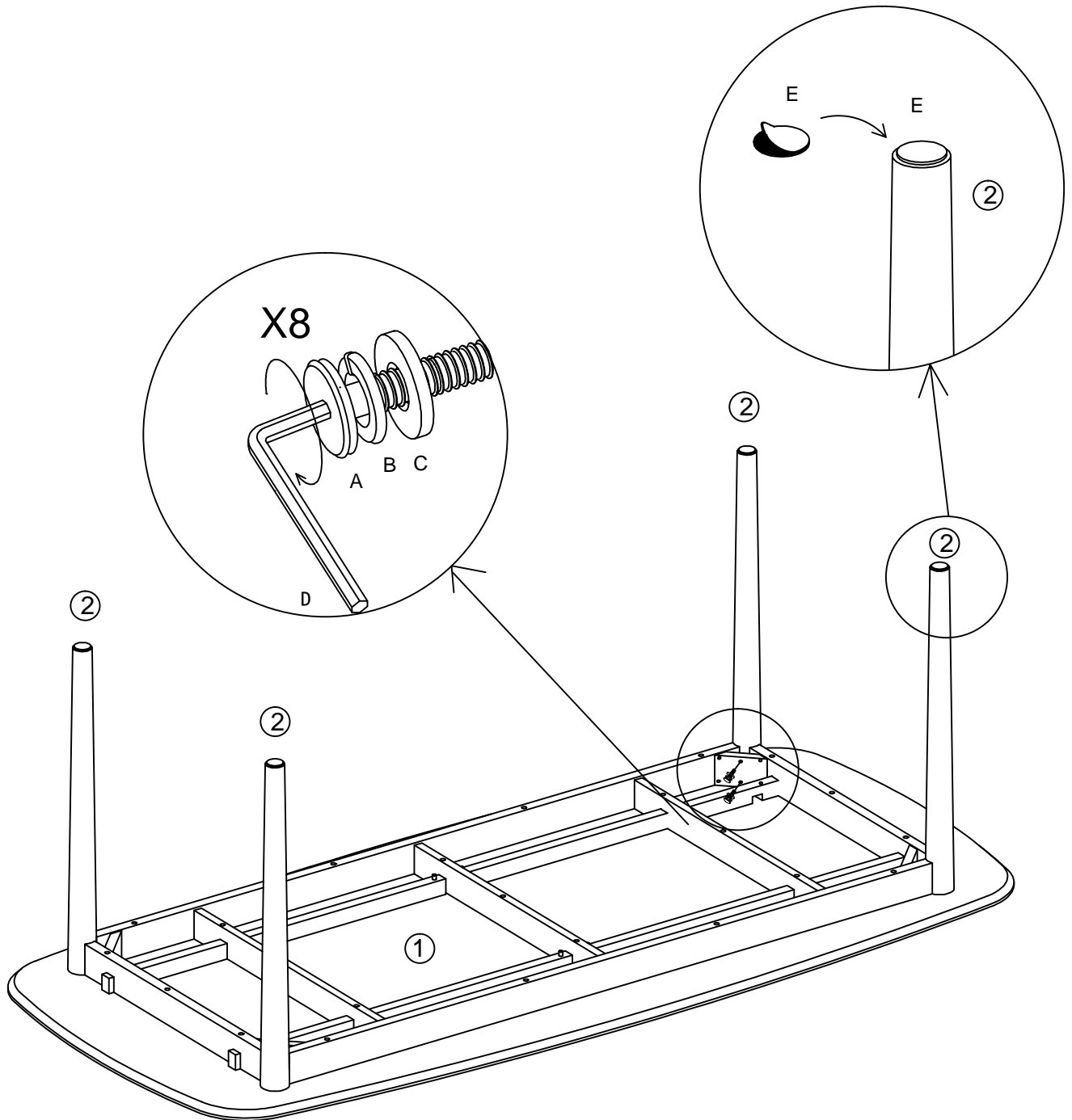

2

