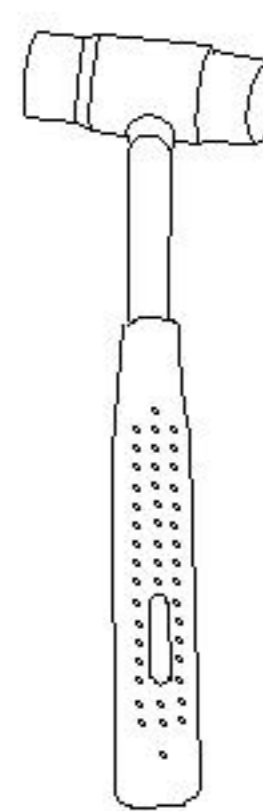
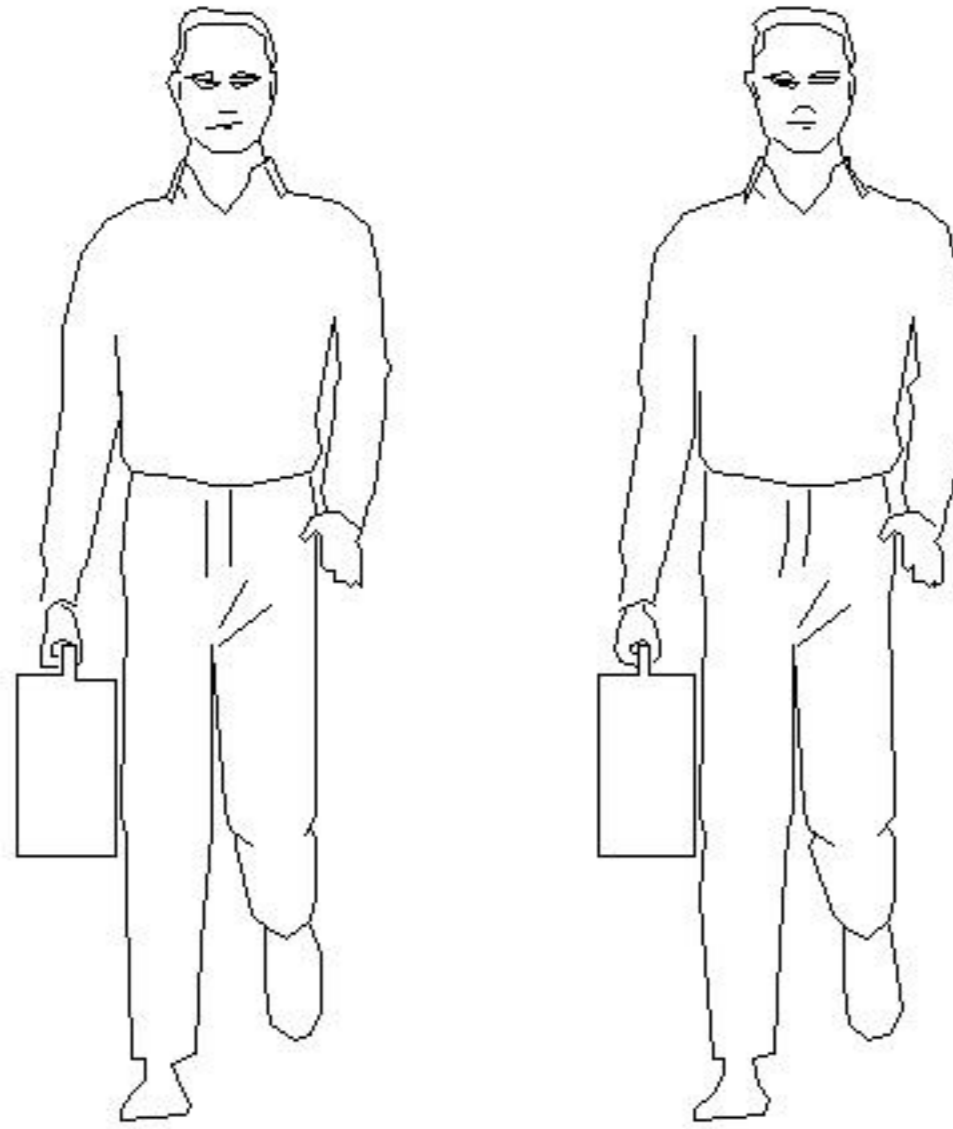

LINSY 林氏家居

五金表/Hardware list

部件表/Parts List

安装示意图/Assembly Instruction

产品名称 Model NO.	PK2R-A
产品规格 Specification	1400*800*750mm
安装工具 Tool	安装人数 Installer
	

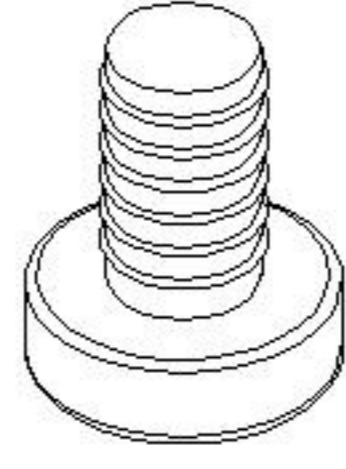
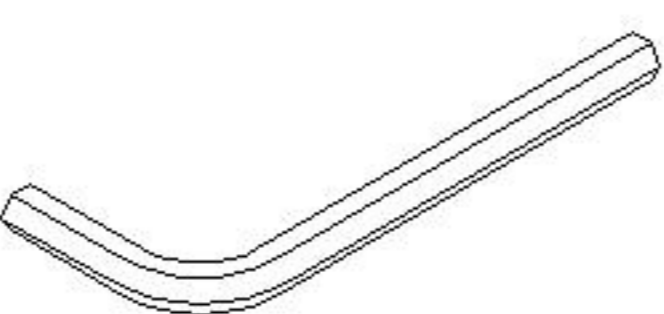
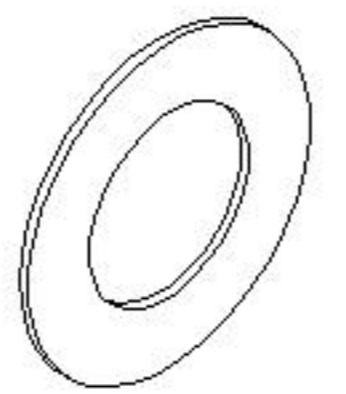
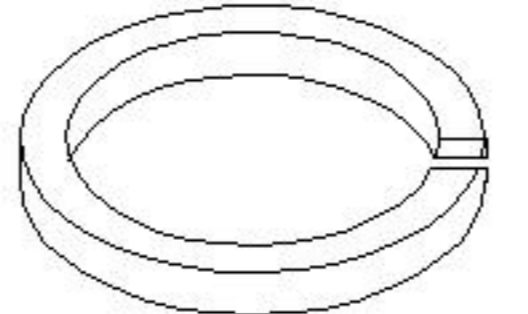
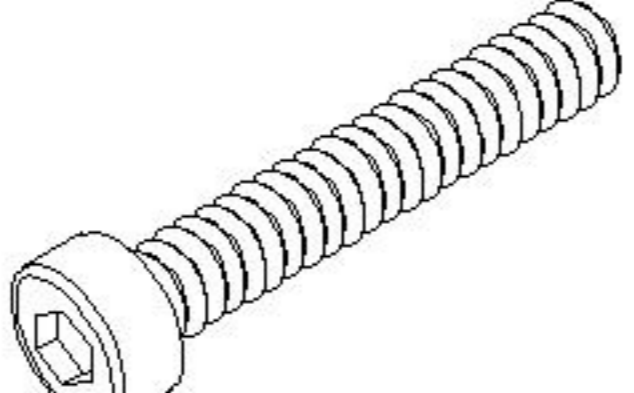
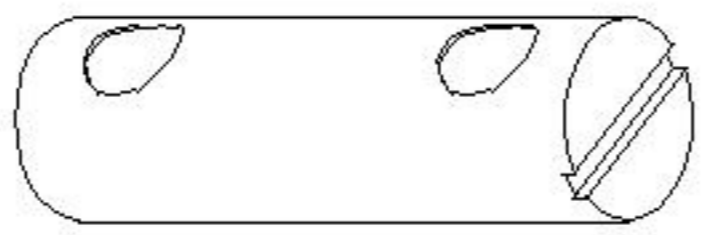
 (A)*4 胶塞-透明防滑PVC Rubber stopper	 (B)*1 6mm内六角扳手 Hexagon wrench-(6mm)	 (C)*8 垫片-M8 Silver shim-M8	 (D)*8 弹簧垫片M8.5 Spring shim
 (E)*8 柱头内六角螺杆 (M8*75mm) Hexagon socket of stigma	 (F)*4 双孔锤母M8 Ø12*60 (M8*75mm) Double hole hammer nut		

编号NO.	名称Name	规格 (mm) Specification	数量QTY	材质Material
①	面板组立 Panel assembly	1400*800*90	1	实木 Wood
②	脚 Foot	725*65*65	4	实木 Wood



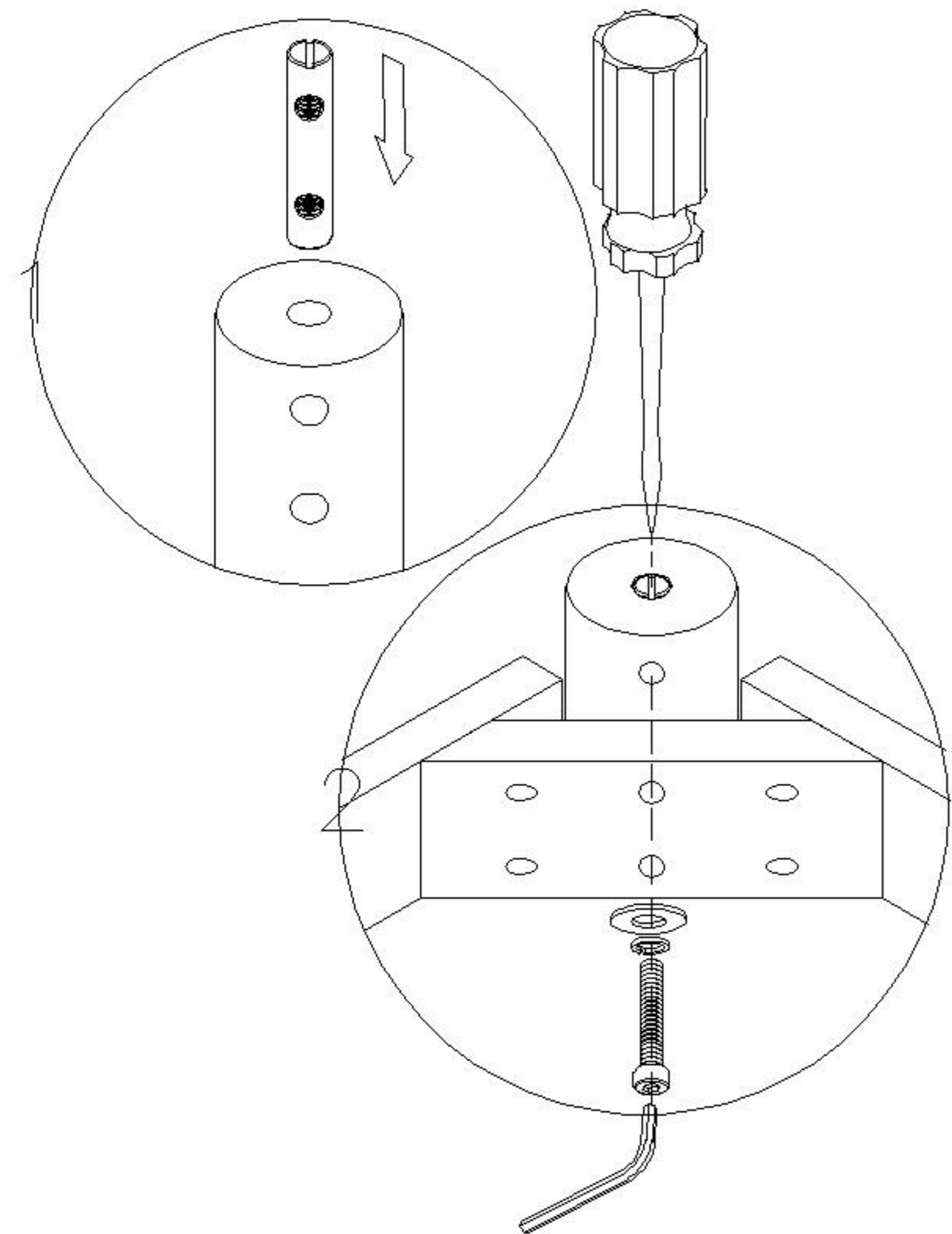

PK2R-A (1.4m)

安装方法/
Installation method

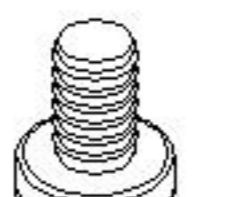
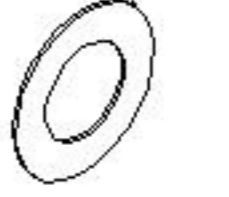
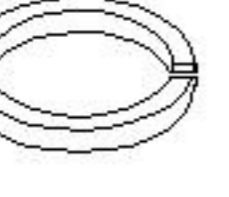
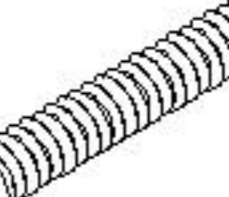

双孔锤母
Double hole hammer nut

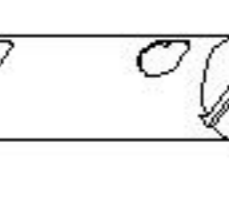
-  (A)*4
-  (C)*8
-  (D)*8
-  (E)*8
-  (B)*1
-  (F)*4

