

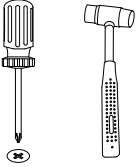

LINSY 林氏家居





五金表/Hardware list

部件表/Parts List

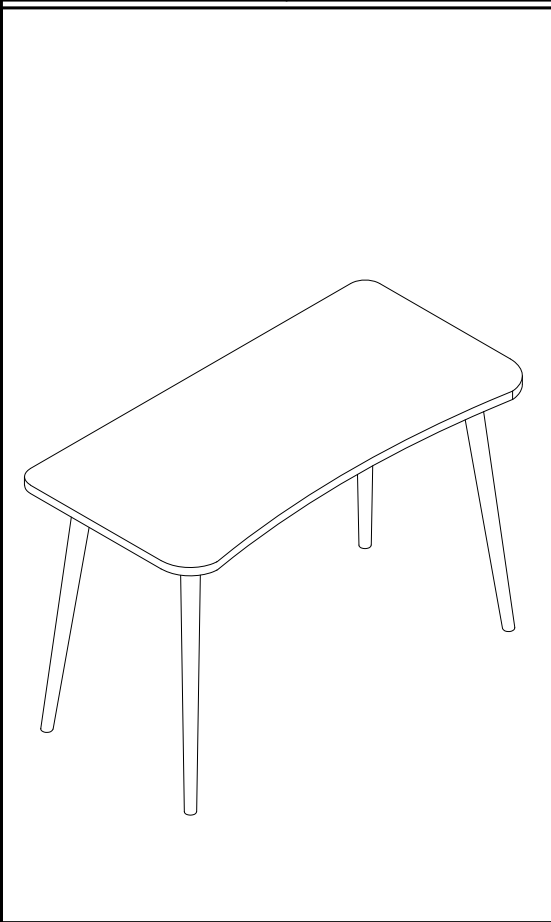
安装示意图/Assembly Instruction

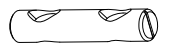
产品名称 Model NO.	JV2V-A 1.0米/m
产品规格 Specification	1000*600*755mm
安装工具 Tool	安装人数 Installer
	

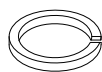
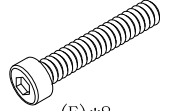

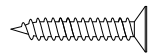
 (A)*4 9厘透明防滑PVC脚垫 Rubber stopper	 (B)*4 双孔锤母M8 Hammer nut	 (C)*8 垫片M8-彩锌 shim-(M8)	 (D)*8 弹簧垫片M8.5 Spring shim
 (E)*8 柱头内六角螺杆-M8x65 Inner hexagon screw	 (F)*1 内六角扳手6mm Hexagon wrench	 (H)*11 自攻螺丝M4x55mm Self-tapping screw	

编号NO.	名称 Name	规格 (mm) Specification	数量QTY	材质 Material
①	面板 Top panel	1000*600*25	1	三胺板 Melamine
②	脚框 Foot frame	777*378*60	1	实木 Wood
③	脚 Foot	737*50*50	4	实木 Wood

JV2V-A 1.0米/m

安装方法/
Installation method

- (A)*4
- (B)*4

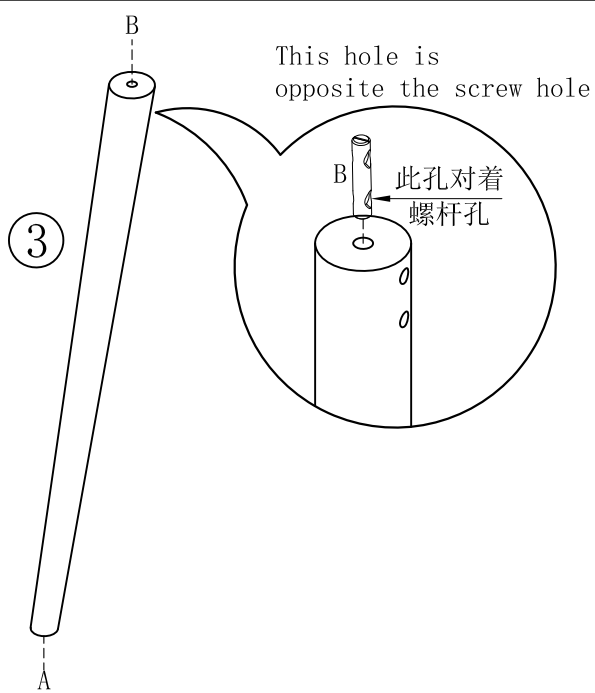

1

- (C)*8
- (D)*8
- (E)*8
- (F)*1

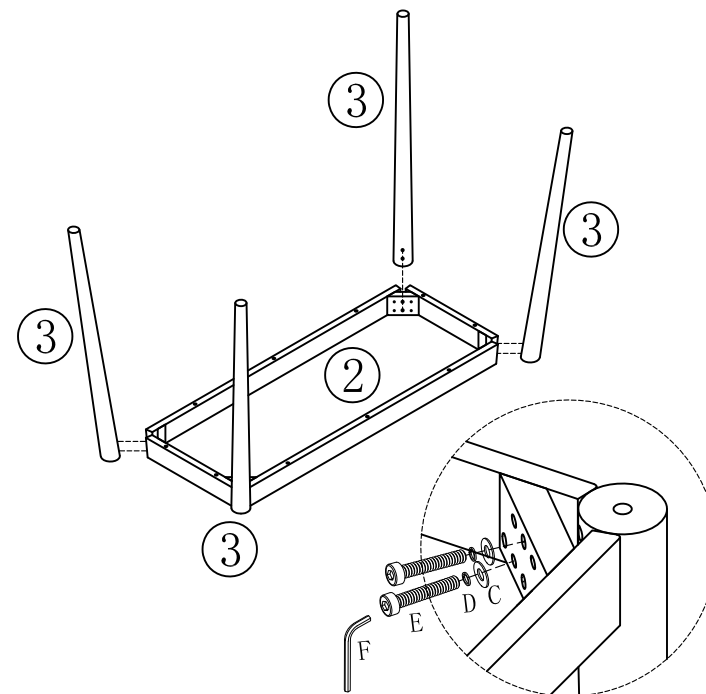

2

- (H)*10

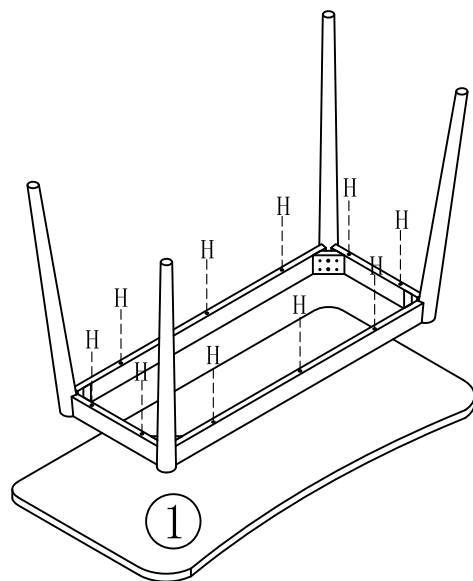

3

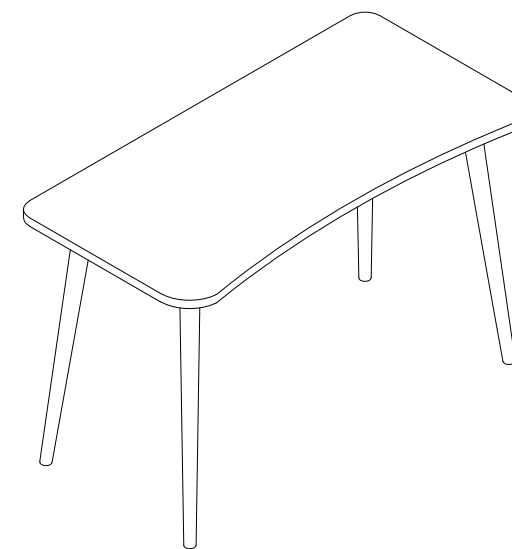

4