

LINSY 林氏家居

安装示意图/Assembly Instruction

产品名称 Model NO. 1012#

产品规格 Specification 三人 3seat

尺寸组合 Combined size 2460*1100*860mm

成品部件明细 Finished Parts Details	编号 NO.	名称 Name	规格 Specification	数量 QTY	材质 Material
	1	三人 3seat	2460*1100*860mm	1	实木+夹板+海绵+布料 Solid wood + Plywood + Sponge + Fabric +
	2				

制图 Draw C20

配件表 Accessories list

编号 NO.	名称 Name	图示 Icon	数量 QTY	三人 3seat
A	说明书(含安装图) Mounting Instruction (with drawing)		1	1
B	(160*78*50mm)橡胶木原木色沙发脚 (160*78*50mm)rubber wood wooden foot		4	4
C	脚-(直径30*106mm)通用铁中脚 diameter 30*106mm iron mid-foot		1	1
D	M8*20斜边内六角螺栓 M8*20bevel hexagon bolt		16	16
E	M10外六角螺母 M10 external hexagon nut		4	4
F	M4*25自攻螺丝 M4*25 self tapping screw		4	4
G	5厘七字内六角扳手 5mm internal hexagonal wrench		1	1
H	(80*80*2mm)沙发脚椭圆孔连接铁片 (80*80*2mm) Sofa foot elliptical hole connecting iron sheet		4	4
J	全牙螺杆-(M8*45mm) threaded rod M8*45		1	1
L	白色魔术布条 White magic strips		1	1
M	M8*80全牙螺杆 M8*80 full tooth screw		8	8
N	14MM开口扳手 (14mm)wrench		1	1
O	M8垫片 M8 pad		8	8
P	M8外六角螺母 M8 external hexagon nut		8	8

如何区分沙发的左右方向?
How to zone the left and right direction of the sofa?

(图示仅供分辨方向用/Picture are for orientation only)

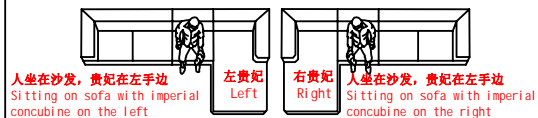

安装人数
Installer



充电式手电钻Cordless hand drill

或者Or



十字螺丝刀Phillips screwdriver

客户安装前须知:

Customers need to know before installation:

此安装图为“三人”的位置关系。

This installation picture is "3seat"

2-1

三人 3seat

STEP 1: 扶手*1对 An * 1 on

图1: 拉开拉链, 取出配件箱
Figure 1: Unzip the accessory case



图2: 中脚安装示意图
Figure 2: Central foot installation schematic diagram



图3步骤①: 木脚弧度顶端对准连接铁片的角, 用自攻螺丝-M4*25和外六角螺母-M10固定好连接铁片

Figure 3 Step ①: Align the top of the arc of the wooden foot with the angle of the connecting iron sheet, and fix the connecting iron sheet with self-tapping screw -M4*25 and hexagon nut -M10

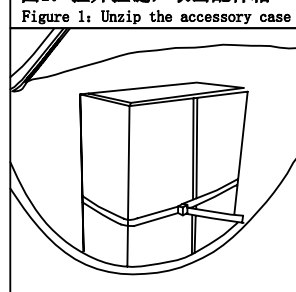
图4: 扶手安装示意图
Figure 4: Handrail installation diagram

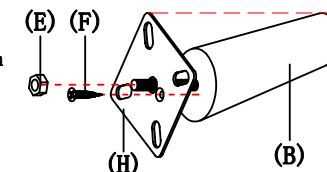
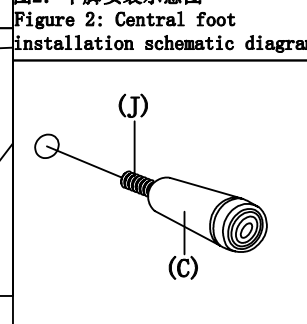

图3步骤②: 边脚安装示意图
Figure 3 Step ②: Schematic diagram of side foot installation



第一步: 扫码关注你的专属客服小林
第二步: 扫码成功后自动弹出安装视频
Step 1. Please scan the QR code below to follow Xiaolin-Your exclusive customer service.
Step 2. A Installation video will pop up automatically after you scanned the QR code successfully

STEP 2:

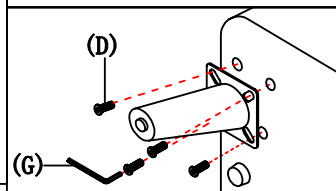
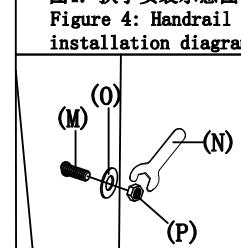
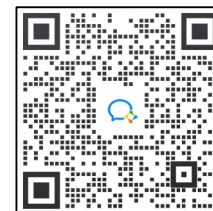
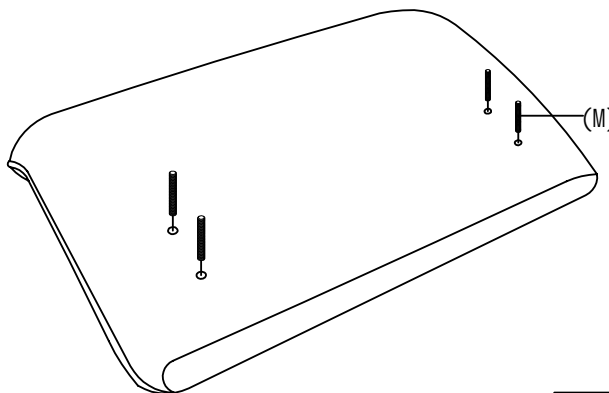
2-2

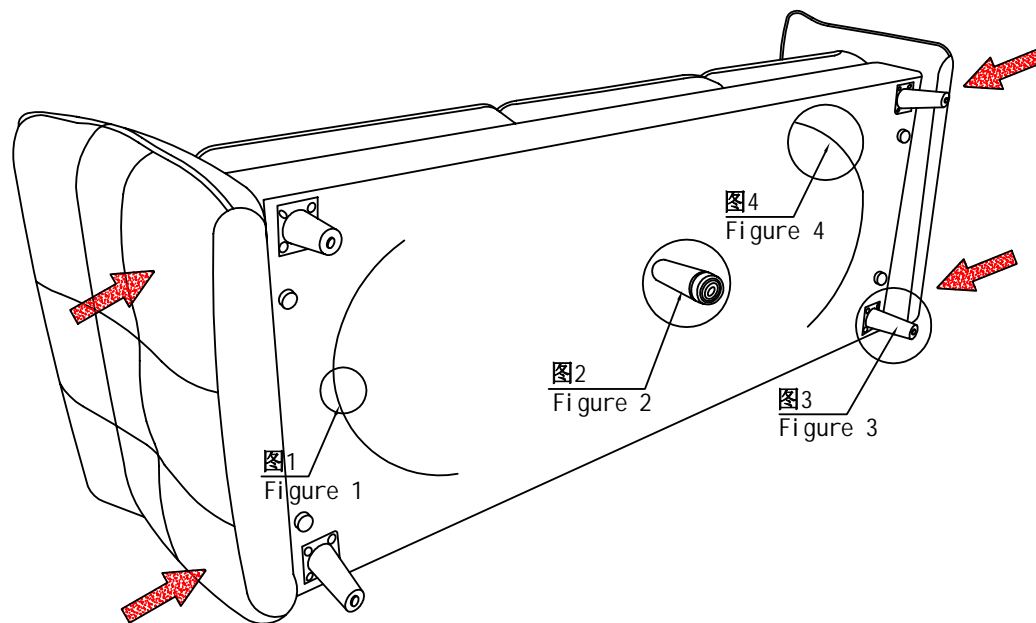

组合图 Combination

三人 3seat

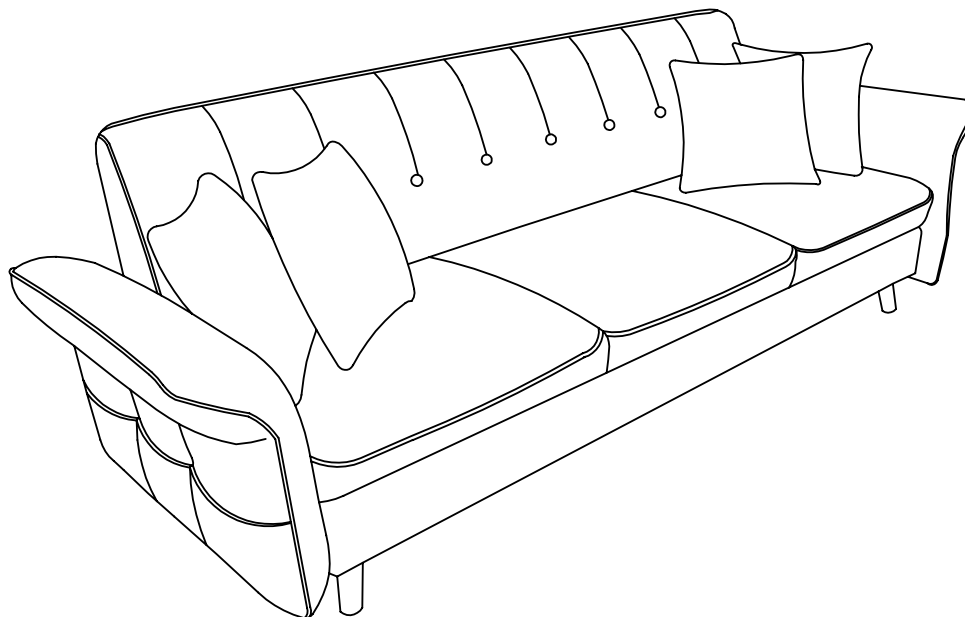

LINSY 林氏家居

安装示意图/Assembly Instruction

产品名称 Model NO. B18#(D)

产品规格 Specification 脚踏 Pedal

尺寸组合 Combined size 640*640*430mm

成品部件明细 Finished Parts Details	编号 NO.	名称 Name	规格 Specification	数量 QTY	材质 Material
	1	脚踏 Pedal	640*640*430mm	1	实木+夹板+海绵+布料 Solid wood + Plywood + Sponge + Fabric
	2				

制图 Draw C20

配件表 Accessories list

编号 NO.	名称 Name	图示 Icon	数量 QTY	脚踏 Pedal
A	说明书(含安装图) Mounting Instruction (with drawing)		1	1
B	(160*78*50mm)橡胶木原木色沙发脚 (160*78*50mm) rubber wood wooden foot		4	4
C	M8*20斜边内六角螺栓 M8*20 bevel hexagon bolt		16	16
D	M10外六角螺母 M10 external hexagon nut		4	4
E	M4*25自攻螺丝 M4*25 self tapping screw		4	4
F	5厘七字内六角扳手 5mm internal hexagonal wrench		1	1
G	(80*80*2mm)沙发脚椭圆孔连接铁片 (80*80*2mm) Sofa foot elliptical hole connecting iron sheet		4	4
I				
J				
K				

如何区分沙发的左右方向?
How to zone the left and right direction of the sofa?

(图示仅供分辨方向用/Picture are for orientation only)

安装人数 Installer

或者Or

客户安装前须知:
Customers need to know before installation:
此安装图为“脚踏”的位置关系。
This installation picture is "Pedal"

1-1

脚踏 Pedal

STEP 1:



图2步骤①: 木脚弧度顶端对准连接铁片的角, 用自攻螺丝-M4*25和外六角螺母-M10固定好连接铁片
Figure 2 Step ①: Align the top of the arc of the wooden foot with the angle of the connecting iron sheet, and fix the connecting iron sheet with self-tapping screw -M4*25 and hexagon nut -M10



图2步骤②: 边脚安装示意图
Figure 2 Step ②: Schematic diagram of side foot installation

组合图 Combination

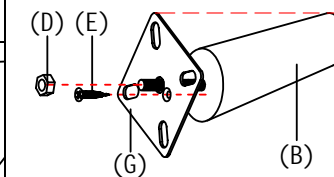
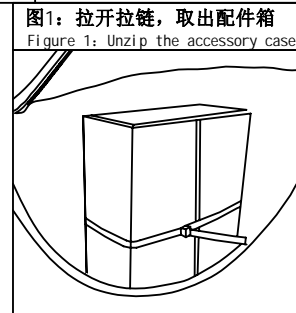
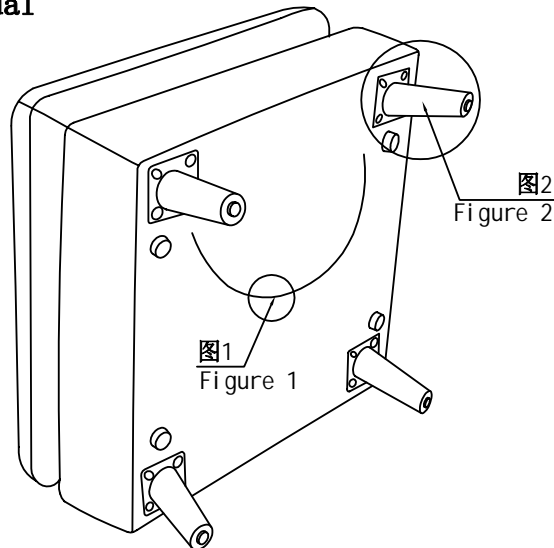
脚踏 Pedal

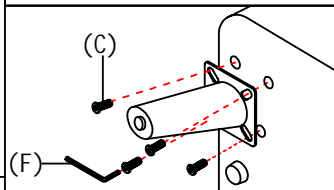