

LINSY 林氏家居

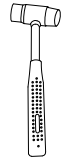

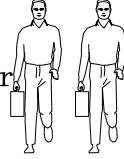

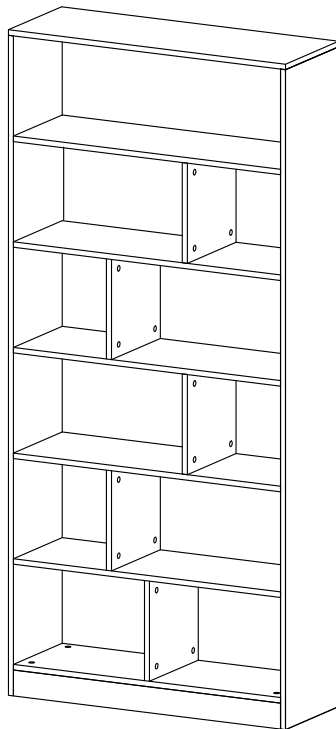

Assembly Instruction

Model NO.	LS253X2-A	Specification	800*295*1795mm
-----------	-----------	---------------	----------------

Tool		Installer	
			



Hardware list

			
(A)*54 3IN1-LOCK	(B)*54 SCREW	(C)*54 PLASTIC	(D)*24 BUCKLE
			
(E)*24 SCREW	(F)*1 ANTI-FALL-DEVICE		



Component list

No.	Name	Size	QTY	Material
①	Top panel	800*295*15	1	Melamine board
②	Bottom pane	770*294*15	1	Melamine board
③	Left side board	1780*295*15	1	Melamine board
④	Right side board	1780*295*15	1	Melamine board
⑤	Layer board	770*294*15	1	Melamine board
⑥	Layer board	770*294*15	1	Melamine board
⑦	Layer board	770*294*15	1	Melamine board
⑧	Layer board	770*294*15	1	Melamine board
⑨	Layer board	770*294*15	1	Melamine board
⑩	Middle board	270*274*15	5	Melamine board
⑪	Back panel	780*280*15	6	Melamine board
⑫	Skirting board	770*70*15	2	Melamine board
⑬	Bar	234*70*15	1	Melamine board

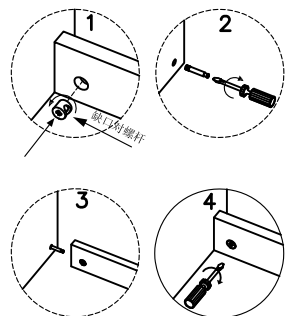
Assembly Instruction



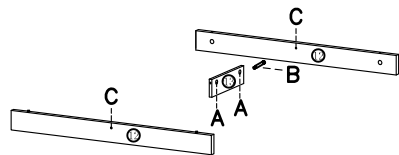

3IN1

-  (A) *2
-  (B) *2
-  (C) *2



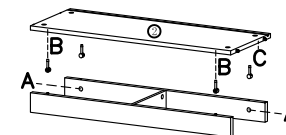

1

-  (A) *4
-  (B) *4
-  (C) *4



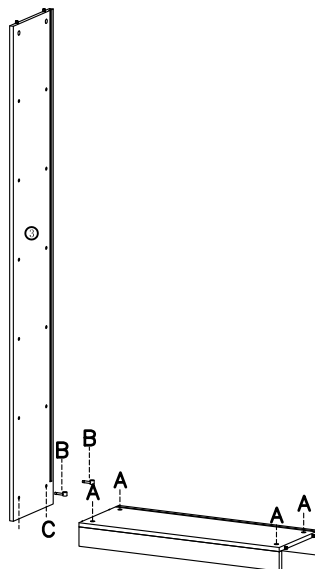

2

-  (A) *2
-  (B) *2
-  (C) *2



3

-  (A) *30
-  (B) *30
-  (C) *30

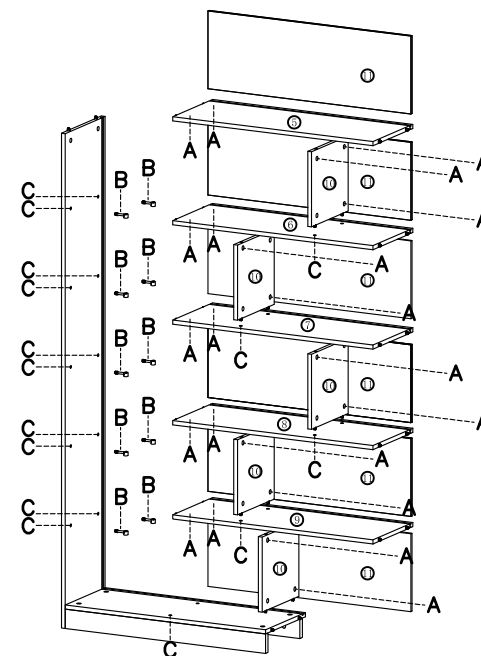

4

Assembly Instruction

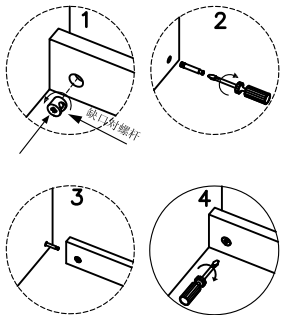

3IN1

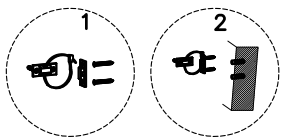

ANTI-Fall device

- (A)*12
- (B)*12
- (C)*12

- (D)*24
- (E)*24
- (F)*1

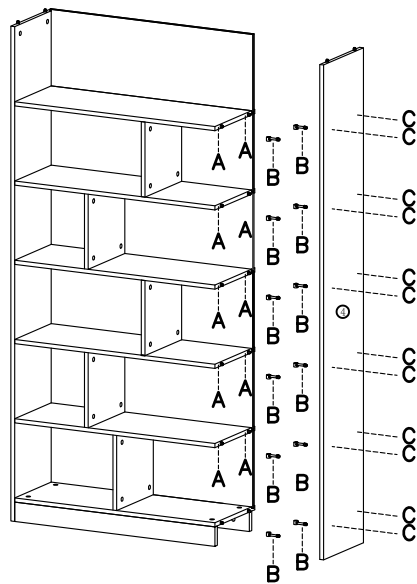

5

- (A)*4
- (B)*4
- (C)*4

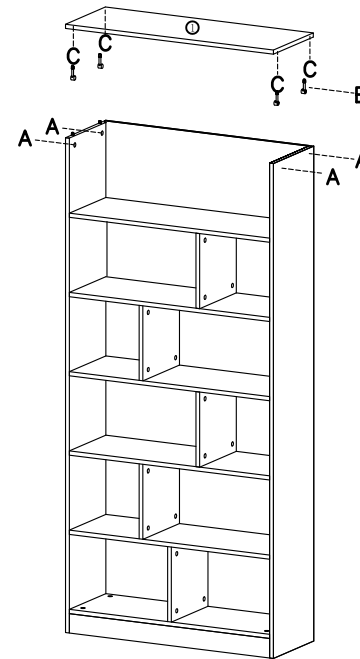

6

7

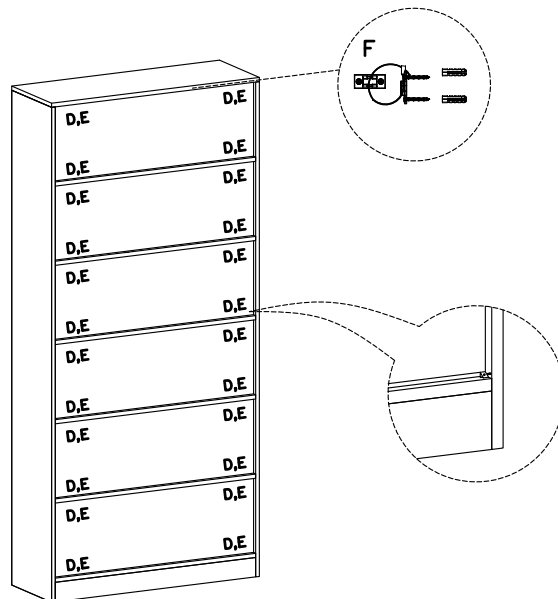

8

